

GROUP 90

CIRCUIT DIAGRAMS

CONTENTS

HOW TO READ CIRCUIT DIAGRAMS	90-4	BACKUP LIGHT	90-63
JUNCTION BLOCK	90-10	TURN SIGNAL LIGHT AND HAZARD WARNING LIGHT	90-64
JOINT CONNECTOR	90-12	METER AND GAUGE	90-68
CENTRALIZED JUNCTION	90-18	BRAKE WARNING LIGHT, OIL WARNING LIGHT, FUEL WARNING LIGHT	90-72
POWER DISTRIBUTION SYSTEM ..	90-24	POWER WINDOWS	90-74
STARTING SYSTEM	90-29	CENTRAL DOOR LOCKING SYSTEM	90-78
IGNITION SYSTEM	90-30	MANUAL AIR CONDITIONING SYSTEM	90-86
CHARGING SYSTEM	90-31	REMOTE CONTROLLED MIRROR ..	90-91
MFI SYSTEM	90-32	WINDSHIELD WIPER AND WASHER	90-92
COOLING SYSTEM	90-42	REAR WINDOW DEFOGGER	90-95
HEADLIGHT	90-44	REAR WIPER AND WASHER	90-96
HEADLIGHT LEVELING SYSTEM ..	90-48	CLOCK	90-99
TAILLIGHT, POSITION LIGHT, SIDE MARKER LIGHT AND LICENSE PLATE LIGHT	90-50	AUDIO SYSTEM	90-100
DOMELIGHT, LUGGAGE COMPARTMENT LIGHT AND IGNITION KEY CYLINDER ILLUMINATION LIGHT	90-54	CIGARETTE LIGHTER	90-103
FOG LIGHT	90-58	ANTI-LOCK BRAKING SYSTEM (ABS)	90-104
HORN	90-61		
STOPLIGHT	90-62		

Continued on next page

SUPPLEMENTAL RESTRAINT SYSTEM(SRS)	90-110	SEAT BELT WARNING LIGHT	90-120
CHARGE AIR COOLER WATER SPLAY SYSTEM	90-114	IGNITION KEY REMINDER TONE ALARM	90-122
IMMOBILIZER SYSTEM	90-116	SUNROOF	90-124
LIGHTING MONITOR TONE ALARM	90-118	RHEOSTAT	90-127

NOTES

HOW TO READ CIRCUIT DIAGRAMS

M1901000100492

The circuit of each system from the fuse (or fusible link) to ground is shown. The power supply is shown at the top and the ground at the bottom to facilitate understanding of how the current flows. Some variations are included in one circuit diagram. Accordingly, some diagrams may not be applicable for individual vehicles.

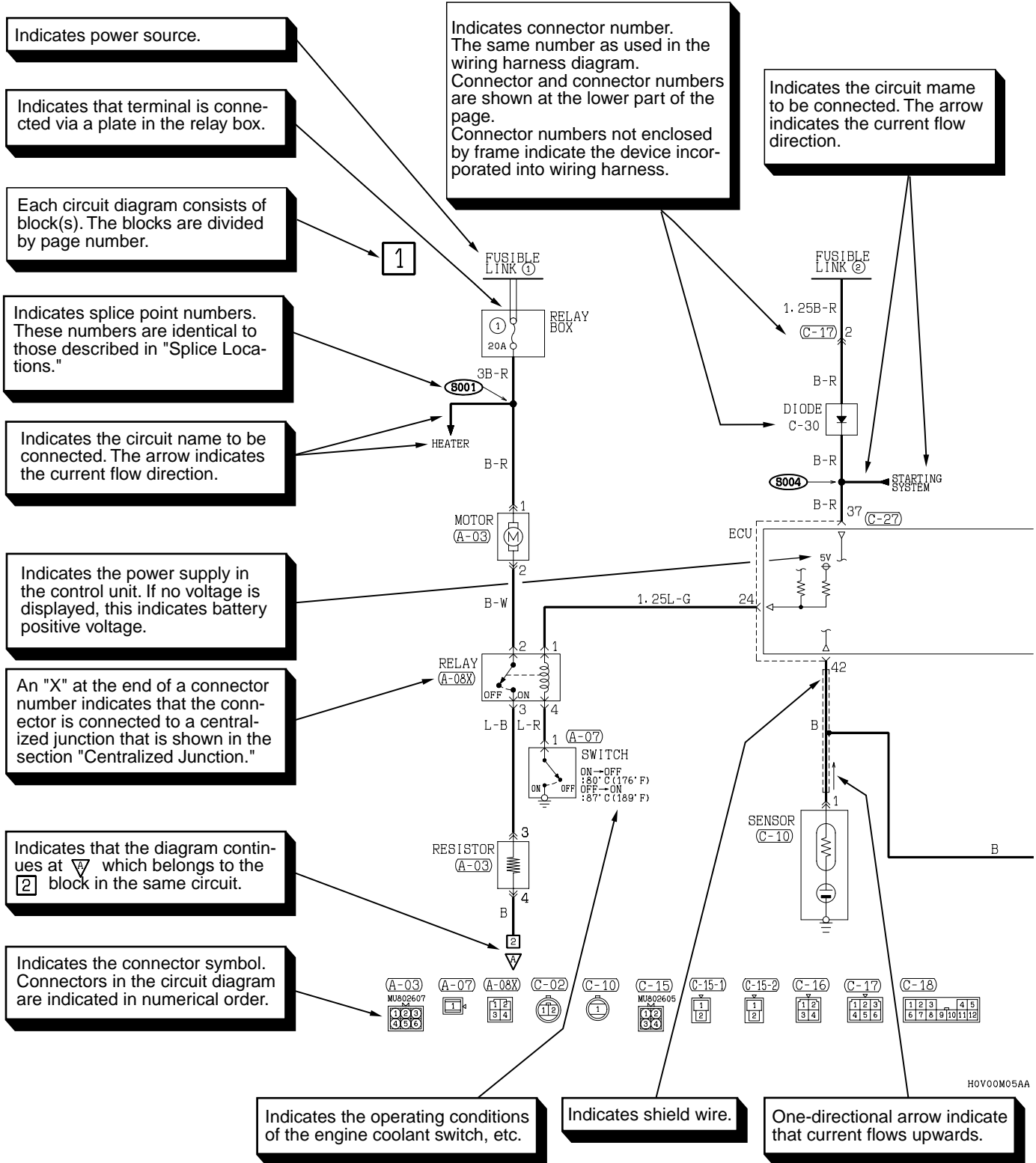





H0V00M05AA

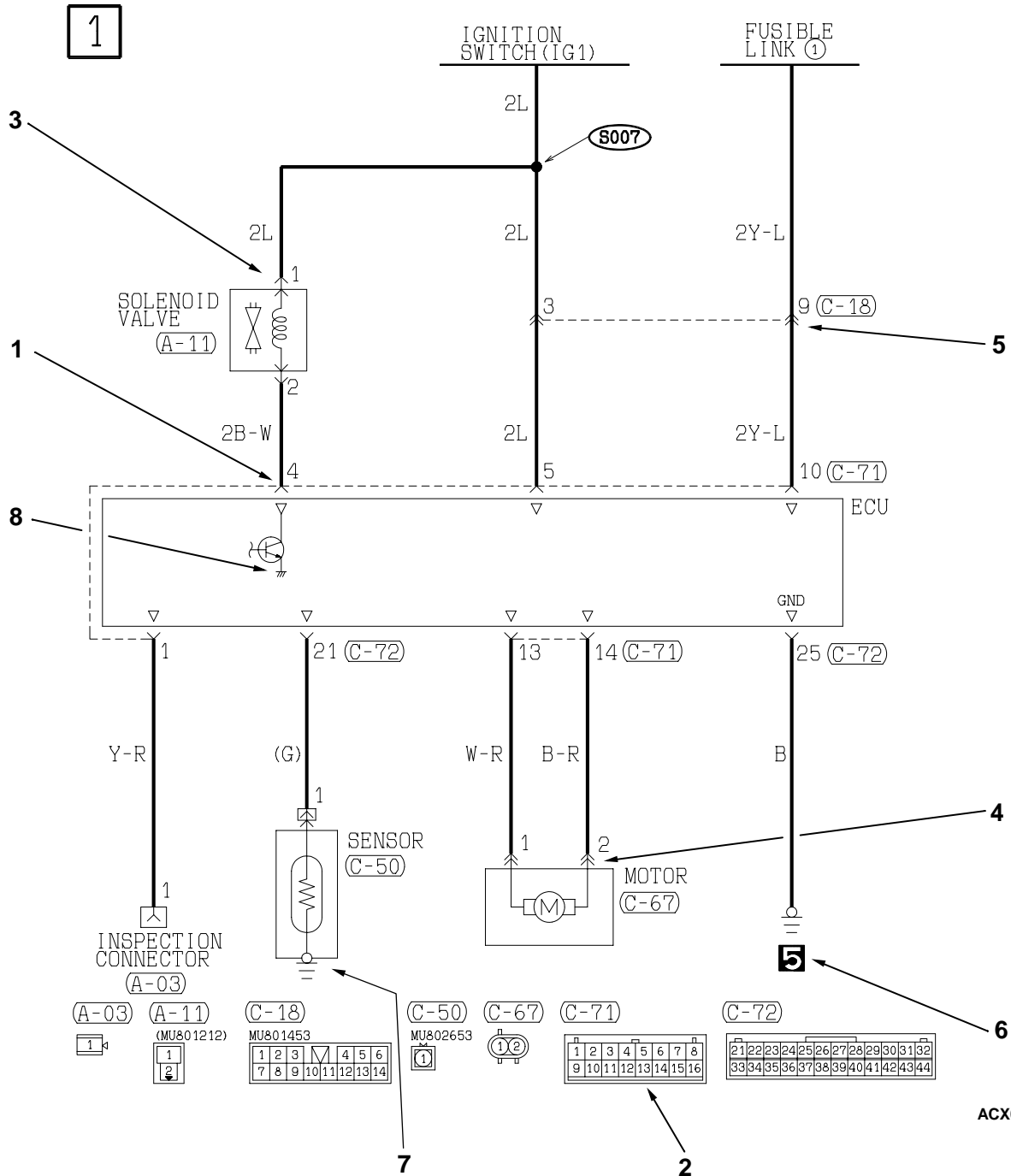



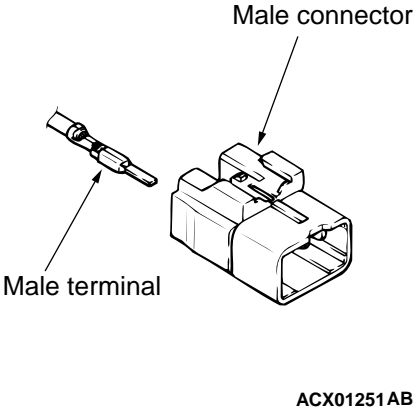

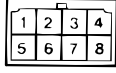
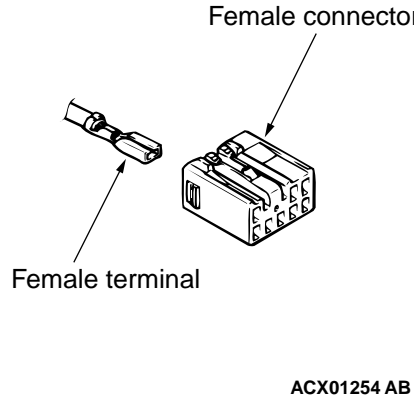

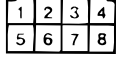
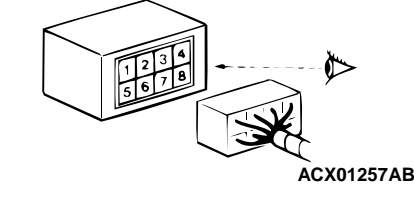
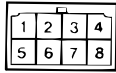
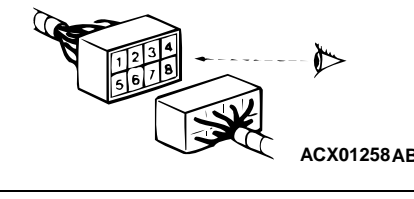
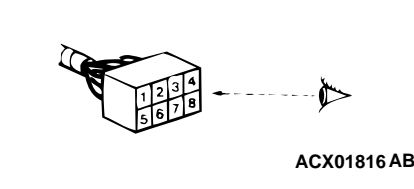
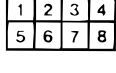
AC106603AC

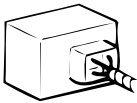
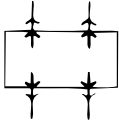
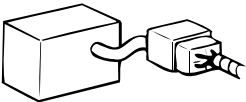
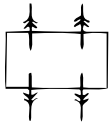
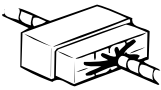
CONNECTOR/GROUNDING INDICATIONS

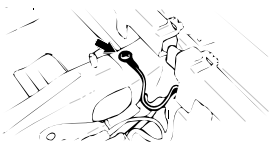





















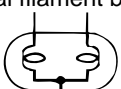

ACX02364 AB

ITEM	NO.	CONNECTOR/ GROUNDING	SYMBOL	CONTENTS
Connector and terminal marking	1		<p>Male terminal</p>  <p>ACX01252 AB</p>	The male and female terminals are indicated as shown. The connector with male terminal(s) is called as male connector and indicated by two connector contour lines, while the connector with female terminal(s) is called as female connector and indicated by single connector contour line.
			<p>Male connector</p>  <p>ACX01253 AB</p>	
			<p>Female terminal</p>  <p>ACX01255 AB</p>	
			<p>Female connector</p>  <p>ACX01256 AB</p>	
Connector symbol marking	2	<p>Device</p> 	 <p>ACX01253</p>	The symbol indicates the connector is viewed as shown. At a device connection, the connector symbol on the device side is shown. For an intermediate connector, the male connector symbol is shown. For spare connectors and check connectors, no device is connected, and so the harness-side connector symbol is shown for these connectors. For the data link connector, its contents differ from the previous description. Refer to "scan tool operation instruction" in detail.
		<p>Intermediate connector</p> 		
		<p>Spare connector, check connector</p> 	 <p>ACX01256</p>	

ITEM	NO.	CONNECTOR/ GROUNDING	SYMBOL	CONTENTS
Connector connection marking	3	Direct connection type  ACX01260 AB	 ACX01261	Connection between a device and the harness is either by direct insertion in the device (direct connection type) or by connection with a harness connector furnished on the device side (harness connection type). The two types are indicated as illustrated.
	4	Harness connection type  ACX01262 AB	 ACX01263	
	5	Intermediate connector  ACX01264 AB	 ACX01265	
Ground markings	6	Body ground  ACX01273 AB	 ACX01274	Grounding is either by body ground, device ground or control unit interior ground. These are indicated as illustrated.
	7	Device ground  ACX01275 AB	 ACX01276	
	8	Ground in control unit  ACX01277 AB	 ACX01278	

SYMBOLS (EXCEPT CONNECTOR AND GROUNDING)

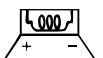
Devices appearing in circuit diagrams are indicated by the following symbols.

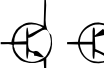
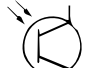
battery  ACX02377AB	buzzer  ACX02378AB	Capacitor  ACX02379AB	electrolytic capacitor  ACX02380AB	Variable capacitor  ACX02381AB	Coil  ACX02382AB
diode  ACX02383AB	light emitting diode  ACX02384AB	photo diode  ACX02385AB	Zener diode  ACX02386AB	Dual filament bulb  ACX02387AC	Single filament bulb  ACX02388AC
Fuse  ACX02389AB	Fusible link  ACX02390AB	horn  ACX02391AB	motor  ACX02392AB	Pulse generator  ACX02393AB	Piezoelectric device  ACX02394AB
Resistor  ACX02395AB	Variable resistor  ACX02396AB	Speaker  ACX02397AB	Thermistor  ACX02398AB	Transistor  ACX02399AB	photo transistor  ACX02400AB

WIRE COLOR CODES

Wire colors are identified by the following color codes.

CODE	WIRE COLOR	CODE	WIRE COLOR	CODE	WIRE COLOR	CODE	WIRE COLOR
B	Black	L	Blue	R	Red	Y	Yellow
BR	Brown	LG	Light green	SB	Sky blue	-	-
G	Green	O	Orange	V	Violet	-	-
GR	Gray	P	Pink	W	White	-	-

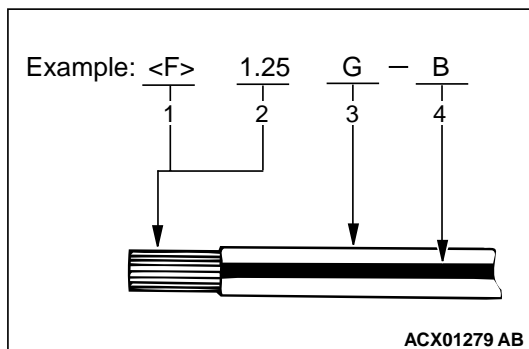

If a cable has two colors, the first of the two color code characters indicates the basic color (color of the cable coating) and the second indicates the marking (tracer) color.

NO.	MEANING
1	<F>: Flexible wire
	<T>: Twisted wire
2	Wire size (mm ²)*
3	Basic color (color of the cable coating)
4	Marking color

NOTE:

*: No code indicates 0.5 mm² (0.0008 in²). Cable color code in parentheses indicates 0.3 mm² (0.0005 in²).

JUNCTION BLOCK

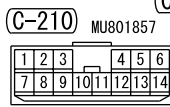
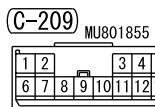
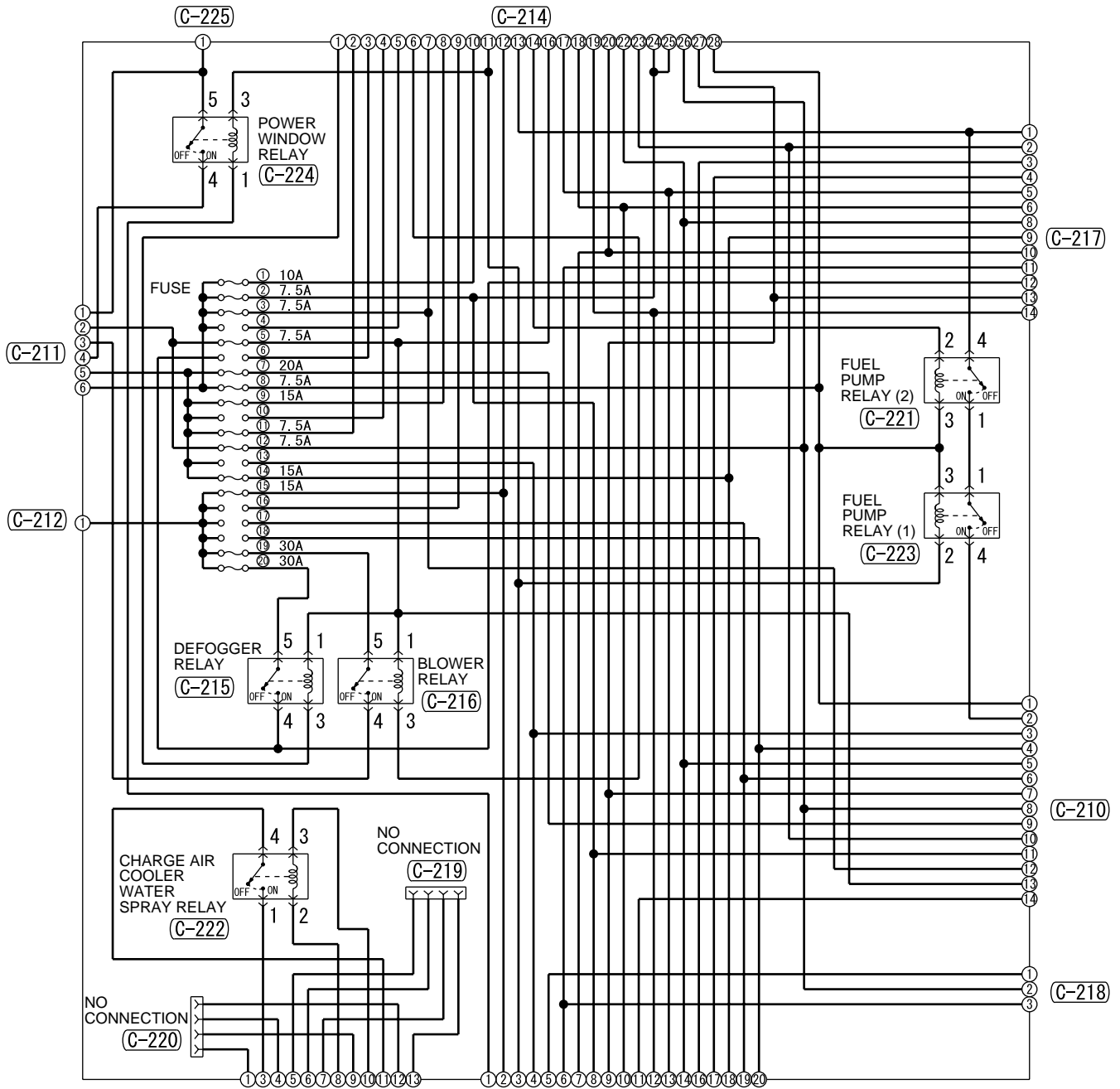

NOTE:
CONNECTOR NUMBERS ARE KEYED TO THE CONFIGURATION
DIAGRAM (DASH PANEL) AND EACH CIRCUIT DIAGRAM.

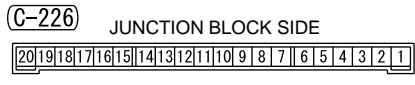
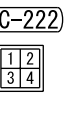
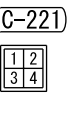
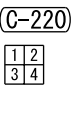
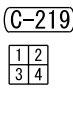
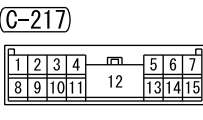
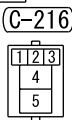
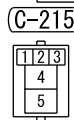
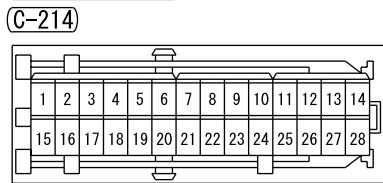

FRONT SIDE

REAR SIDE

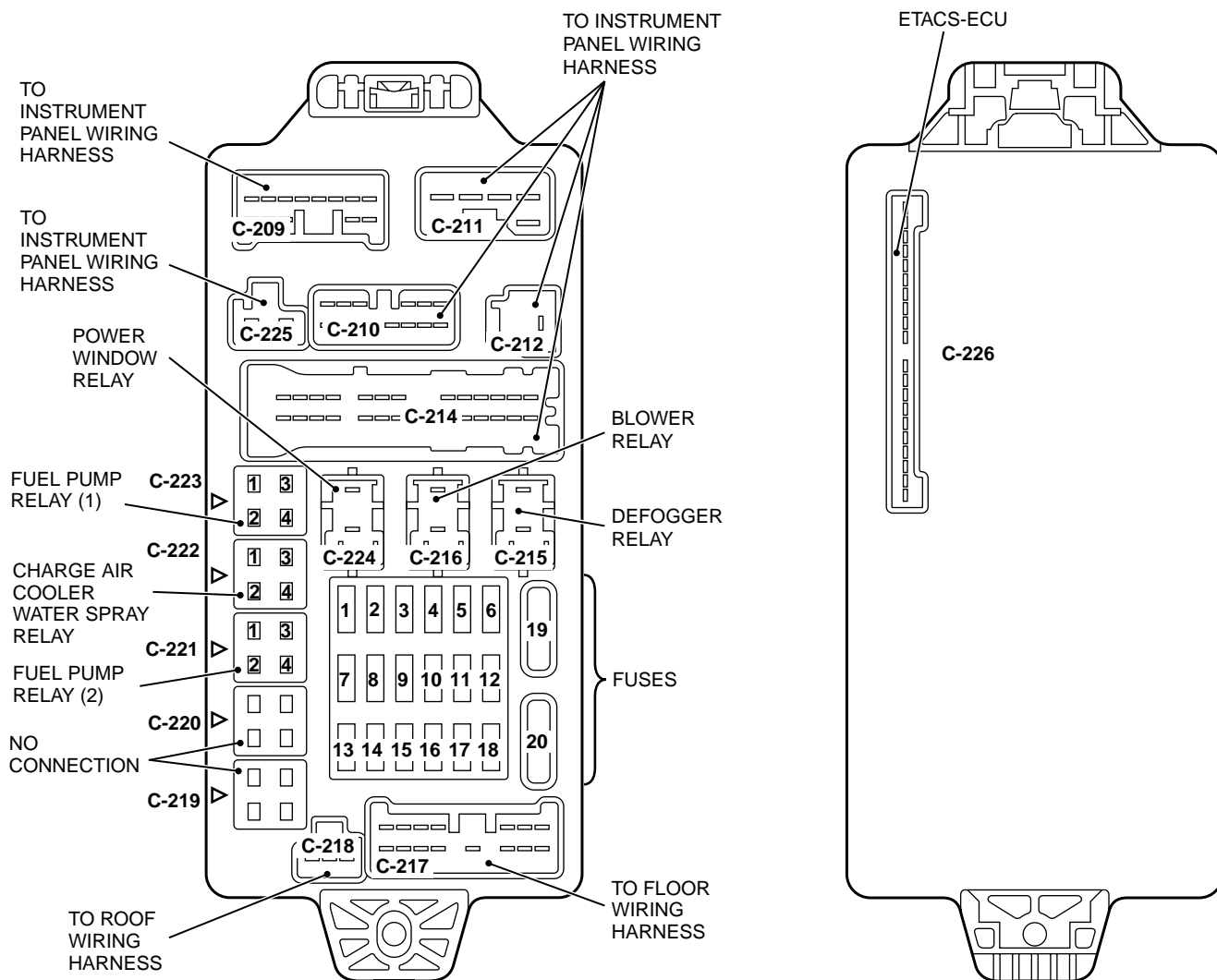

AC208685AB

NOTE:

- The terminals of the fuel pump relay, heated seat relay and rear blower relay are numbered when the junction block's triangle mark row is positioned above.

JOINT CONNECTOR

M1901014200511

NOTE: IN THE ACTUAL VEHICLES, SOME OF THE JOINT CONNECTOR TERMINALS IN THE SAME BUS ARE USED, SO IN SOME CASES, THE TERMINAL ARRANGEMENT INDICATED ON THE CIRCUIT DIAGRAMS DO NOT COINCIDE WITH THE ONES IN THE ACTUAL VEHICLES.

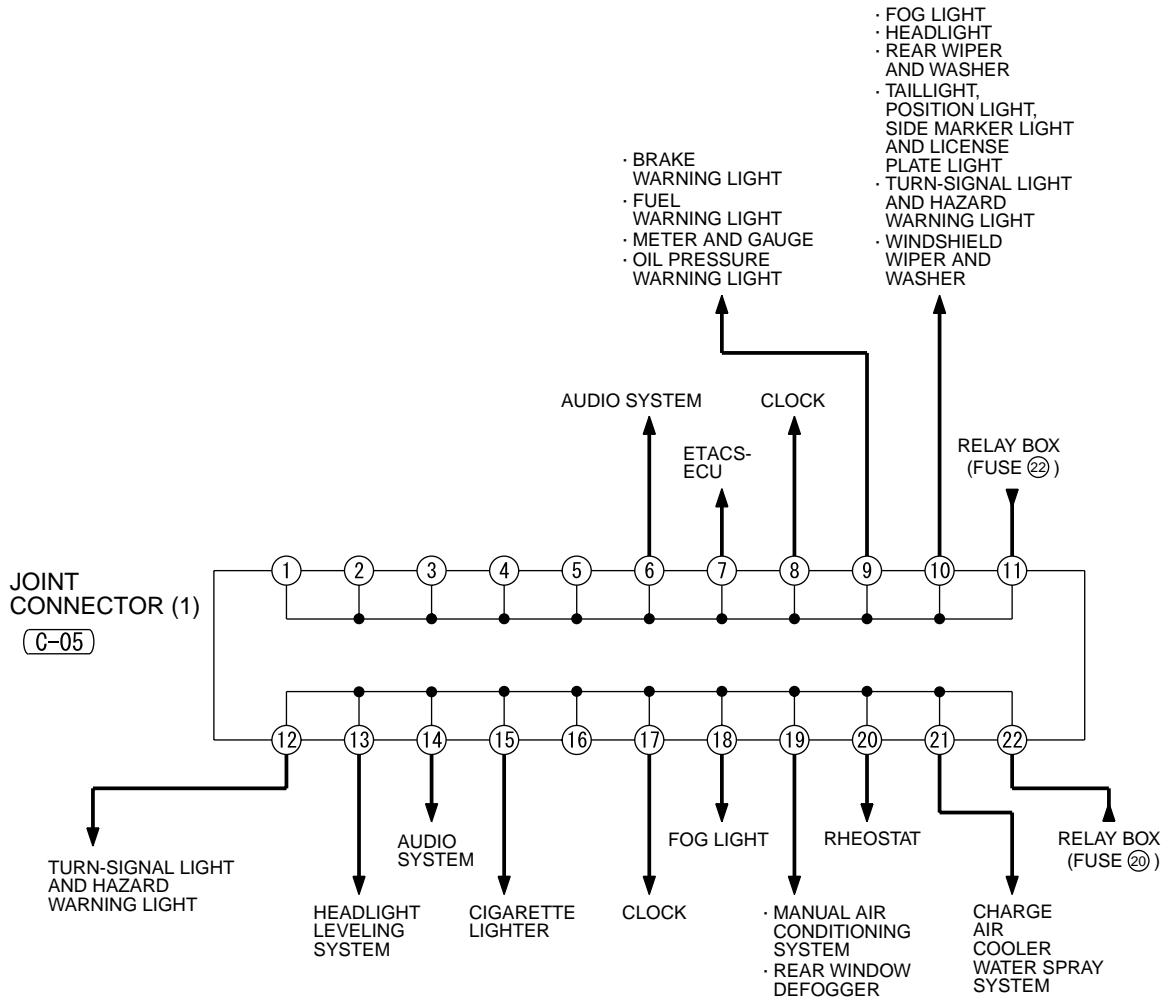

(C-05)

(C-101)

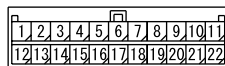
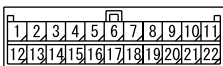

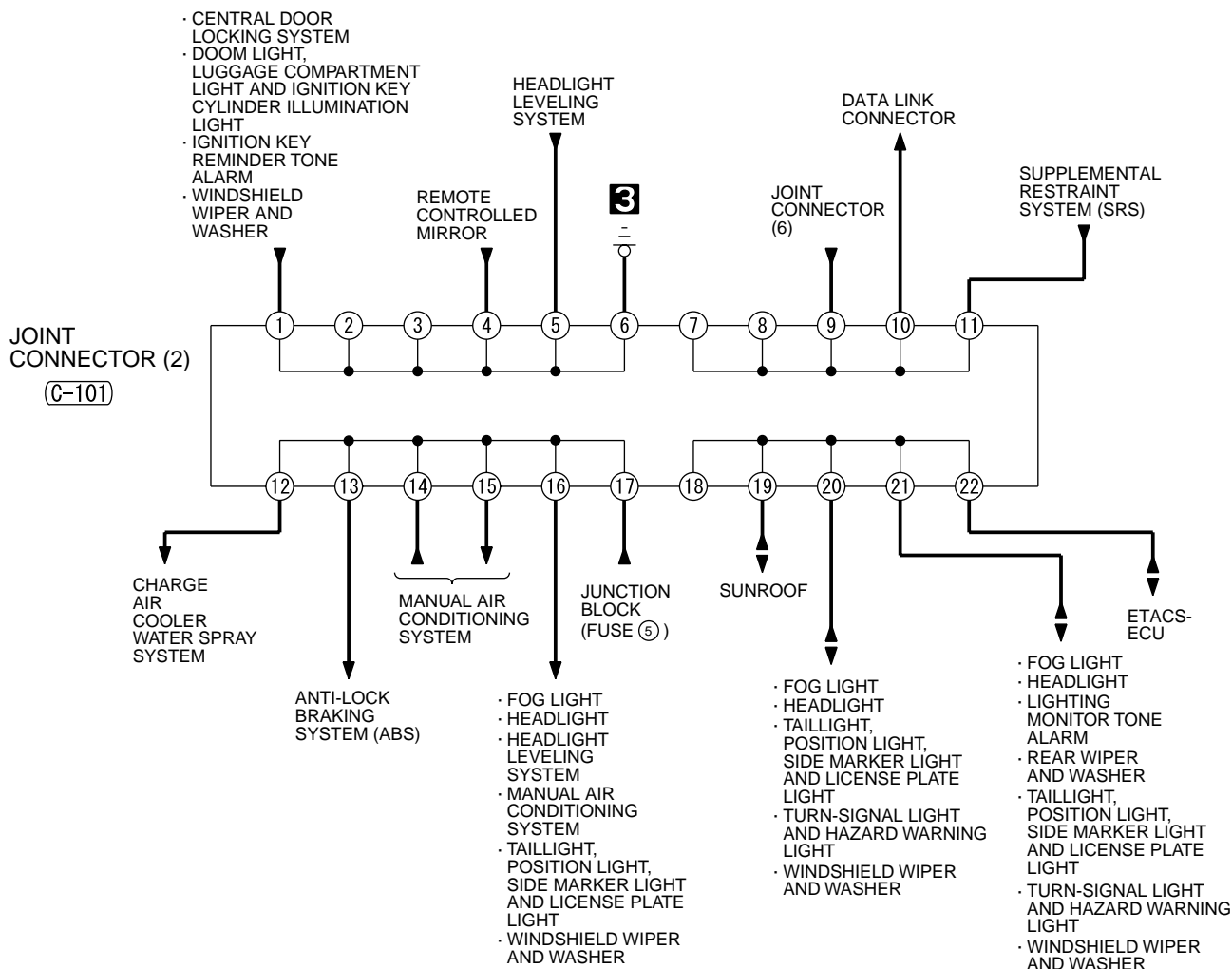

JOINT CONNECTOR (CONTINUED)

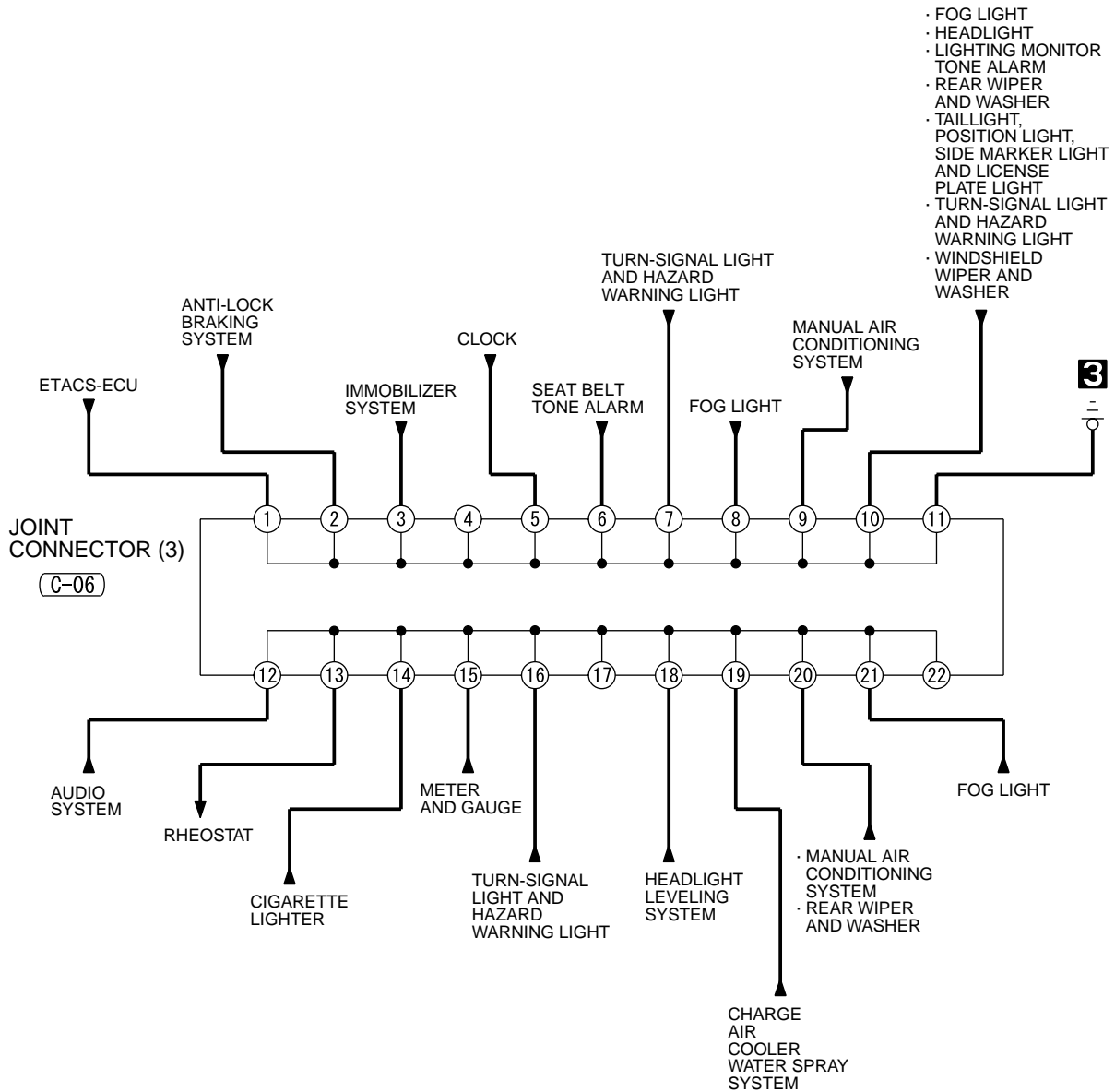

C-06

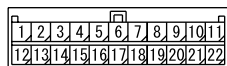

C-23

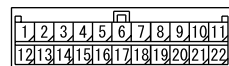

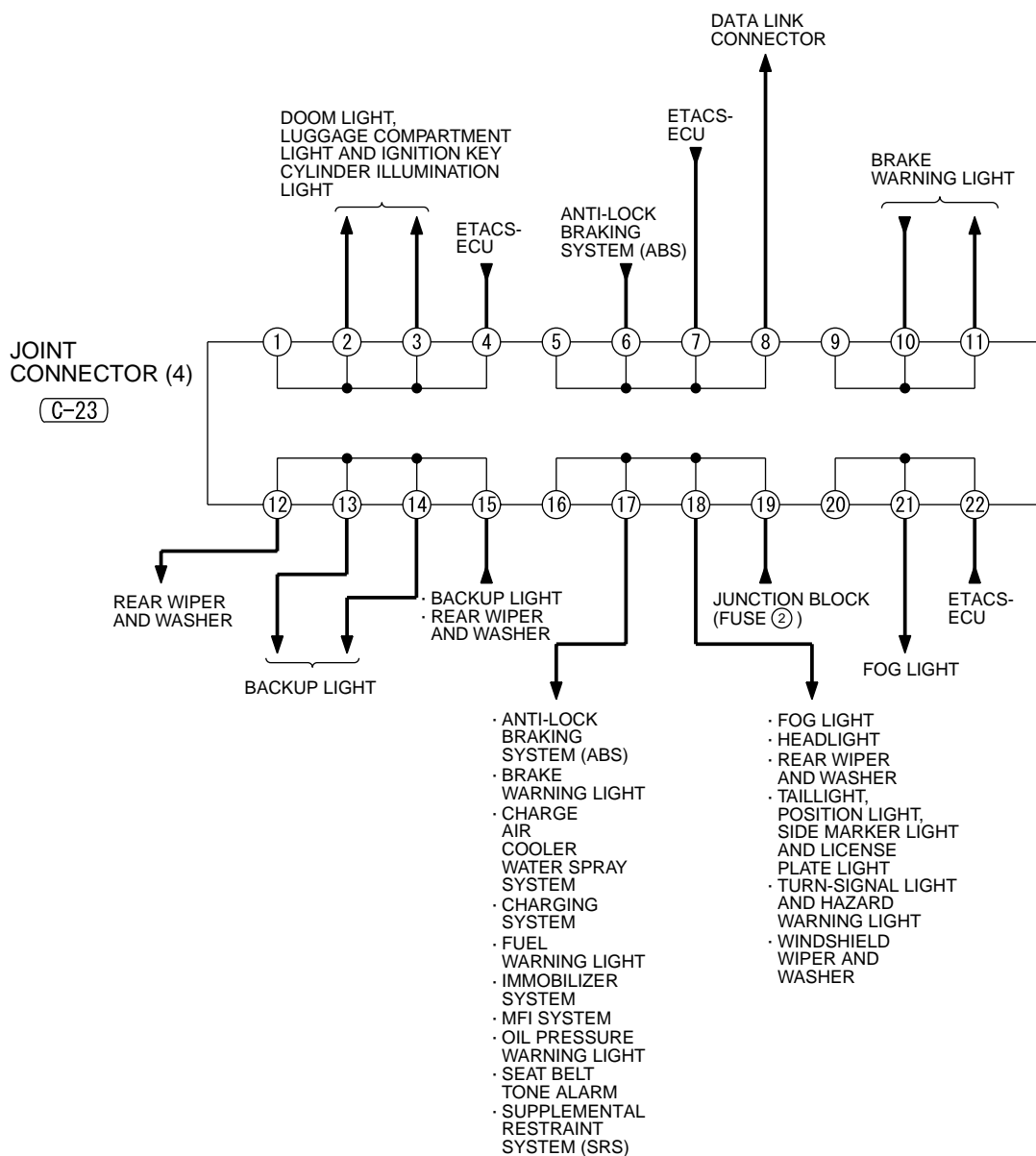

JOINT CONNECTOR (CONTINUED)

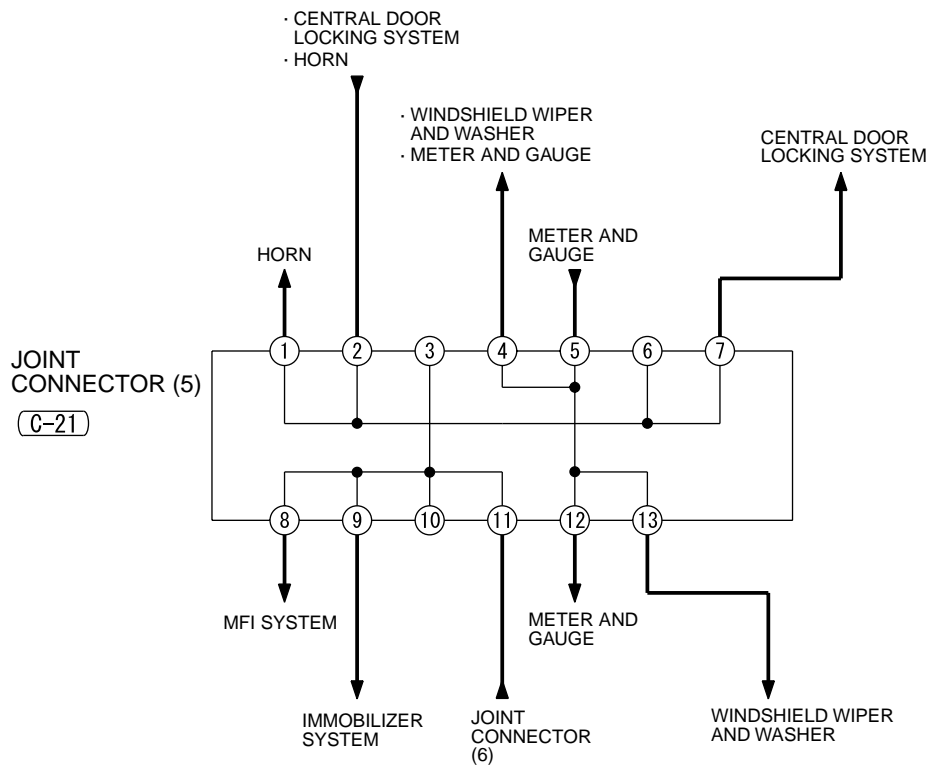

(C-21) MU801855

1	2	3	4	5
6	7	8	9	10
11	12	13		

(C-105)

1	2	3	4	5	6	7	8	9	10	11
12	13	14	15	16	17	18	19	20	21	22
23	24	25	26	27	28	29	30	31	32	33

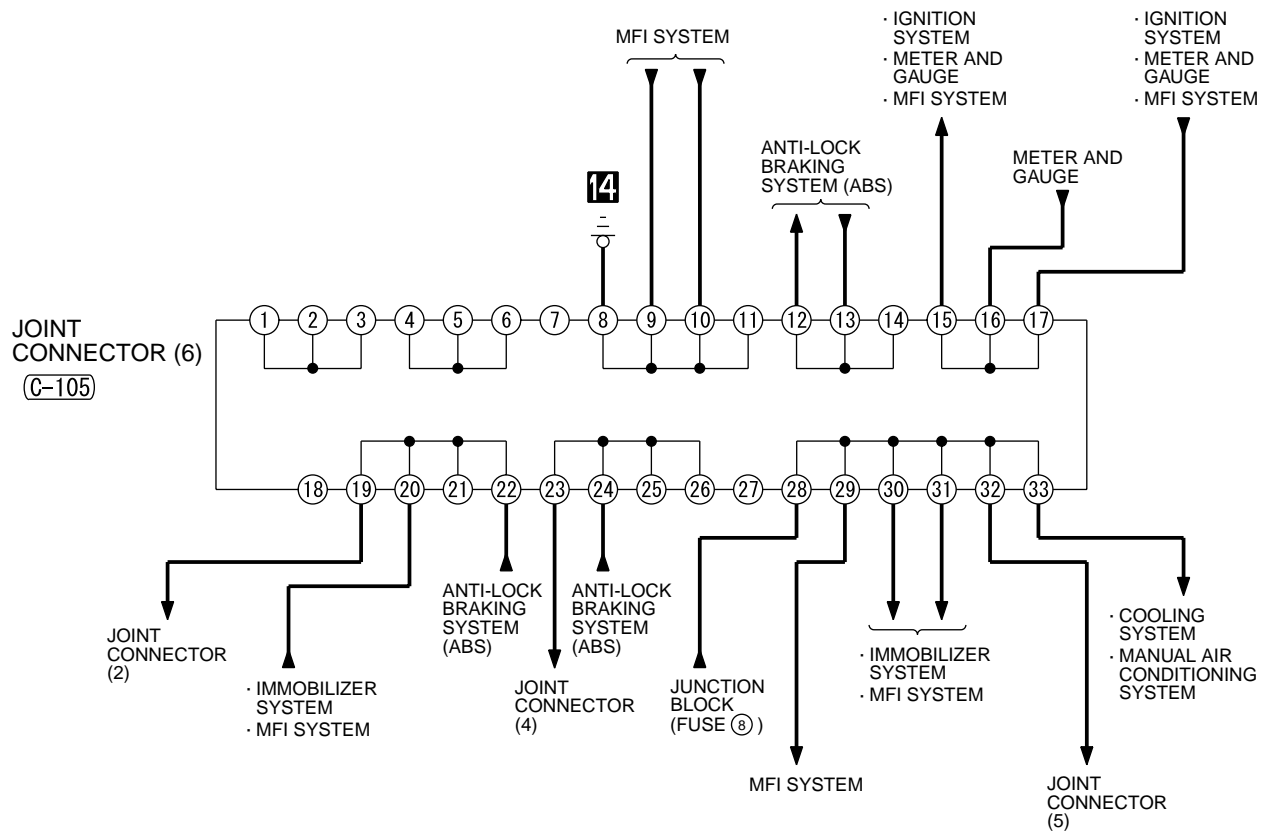

CENTRALIZED JUNCTION

M1901000300571

FUSIBLE LINK AND FUSE

ENGINE COMPARTMENT

NO.	POWER SUPPLY CIRCUIT	NAME	RATED CAPACITY (A)	HOUSING COLOR	LOAD CIRCUIT
1	Battery/Alternator (Fusible link No.26)	Fusible link	60	Yellow	Fuse No.15,16,17,18,19,20 (in junction block) circuit
2			50	Red	Fan control module
3			60	Yellow	ABS-ECU
4			40	Green	Ignition switch circuit
5			30	Pink	Fuse No.21 (in junction block) circuit, power window main switch and power window sub switch
6		Fuse	15	Blue	Fog light relay
7			10	Red	Horn relay
8			20	Yellow	MFI relay and engine control module
9			10	Red	A/C compressor relay
10			15	Blue	ABS-ECU, high-mounted stop light, immobilizer-ecu and rear combination light
11			30	Green	Condenser fan motor
12			7.5	Brown	Generator
13			10	Red	ETACS-ECU
14			-	-	-
15			15	Blue	Fuel pump
16	Front-ECU (Headlight relay: High)	10	Red	Headlight	
17		10	Red	Headlight and high-beam indicator light	
18	Front-ECU (Headlight relay: Low)	20	Yellow	Front combination light	
19		20	Yellow	Front combination light and headlight leveling switch	
20	Front-ECU (Taillight relay)	7.5	Brown	A/C-ECU, clock, radio, CD player, cigarette lighter illumination light, ashtray illumination light, rheostat, front combination light, rear combination light, hazard warning switch, headlight leveling switch, fog light switch, charge air cooler water spray switch	
21		7.5	Brown	Combination meter, front combination light, rear combination light and license plate light, side marker light	

NO.	POWER SUPPLY CIRCUIT	NAME	RATED CAPACITY (A)	HOUSING COLOR	LOAD CIRCUIT
22	Battery/Alternator (Fusible link No.26)	Fuse	10	Red	Clock, column switch, combination meter, ETACS-ECU, front-ECU, radio and CD player
23	Ignition switch (ACC)		10	Red	ETACS-ECU, radio and CD player
24	-		-	-	-
25	Battery/Alternator (Fusible link No.26)	Fusible link	30	Green	Condenser fan motor
26	Generator		100	-	Battery

(RELAY BOX IN ENGINE COMPARTMENT)

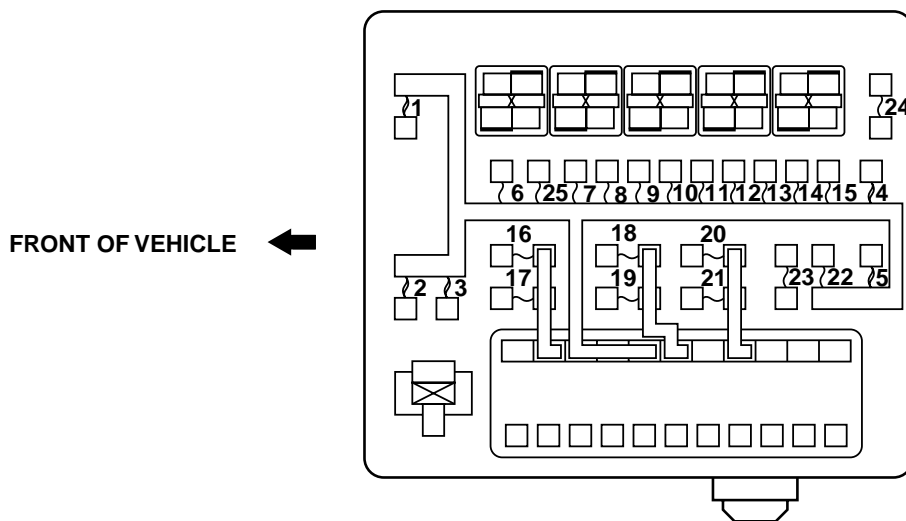

(CONNECTED DIRECTLY TO BATTERY POSITIVE (+) TERMINAL)

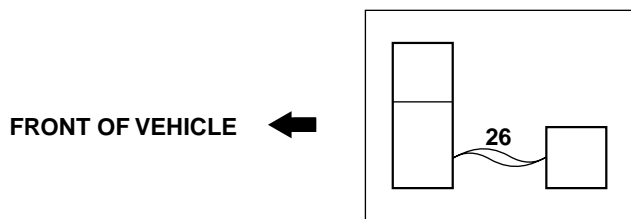

PASSENGER COMPARTMENT

NO.	POWER SUPPLY CIRCUIT		NAME	RATED CAPACITY (A)	HOUSING COLOR	LOAD CIRCUIT
1	Ignition switch	IG1	Fuse	10	Red	Ignition coil
2				7.5	Brown	Combination meter, ETACS-ECU, SRS-ECU, vehicle speed sensor and immobilizer-ECU
3				7.5	Brown	ETACS-ECU, backup light switch, column switch
4				-	-	-
5		IG2		7.5	Brown	A/C-ECU, blower relay, defogger relay, front-ECU outside/inside air selection damper control motor, charge air cooler water spray relay and steering wheel sensor
6	Fuse No.20 <in junction block (Defogger relay)>			-	-	-
7	Ignition switch	ACC		20	Yellow	Front-ECU
8		IG1		7.5	Brown	Fuel pump relay (1), fuel pump (2), engine control module
9		ACC		15	Blue	Cigarette lighter
10				-	-	-
11				7.5	Brown	Remote control mirror switch
12		IG2		7.5	Brown	ABS-ECU and sunroof motor assembly
13		ACC		-	-	-
14				15	Blue	ETACS-ECU
15		Fusible link No.1 Battery/alternator			15	Blue
16				-	-	-
17				-	-	-
18				-	-	-
19				30	Green	Blower motor and resistor
20				30	Green	Defogger
21	Fusible link No.5 Battery/alternator			20	Yellow	Sunroof motor assembly
22	-			-	-	-
23	Ignition switch	IG2		10	Red	Charge air cooler water spray motor
24	-			-	-	-

(IN JUNCTION BLOCK)

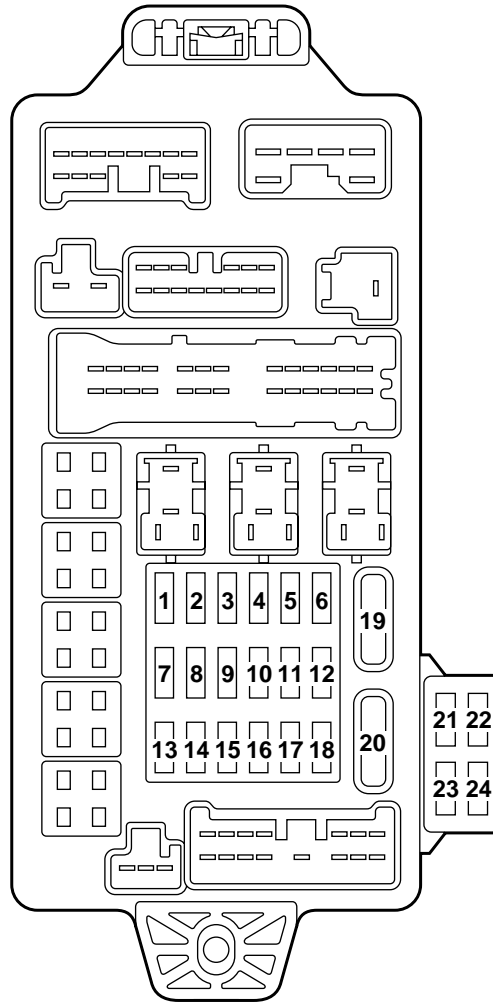

AC201677AB

CENTRALIZED RELAY

CONNECTOR NO.	NAME	CONNECTOR NO.	NAME
A-04X	Fog light relay	B-06X	Engine speed detection connector
A-05X	Horn relay	B-07X	Starter relay
A-06X	Condenser fan relay (LO)	B-08X	-
A-07X	Condenser fan relay (HI)	B-09X	-
A-08X	-	B-10X	-
A-09X	Fan control relay	B-11X	-
A-10X	Front-ECU	B-12X	MFI relay
A-11X	Front-ECU	B-13X	A/C compressor relay

(RELAY BOX IN ENGINE COMPARTMENT)

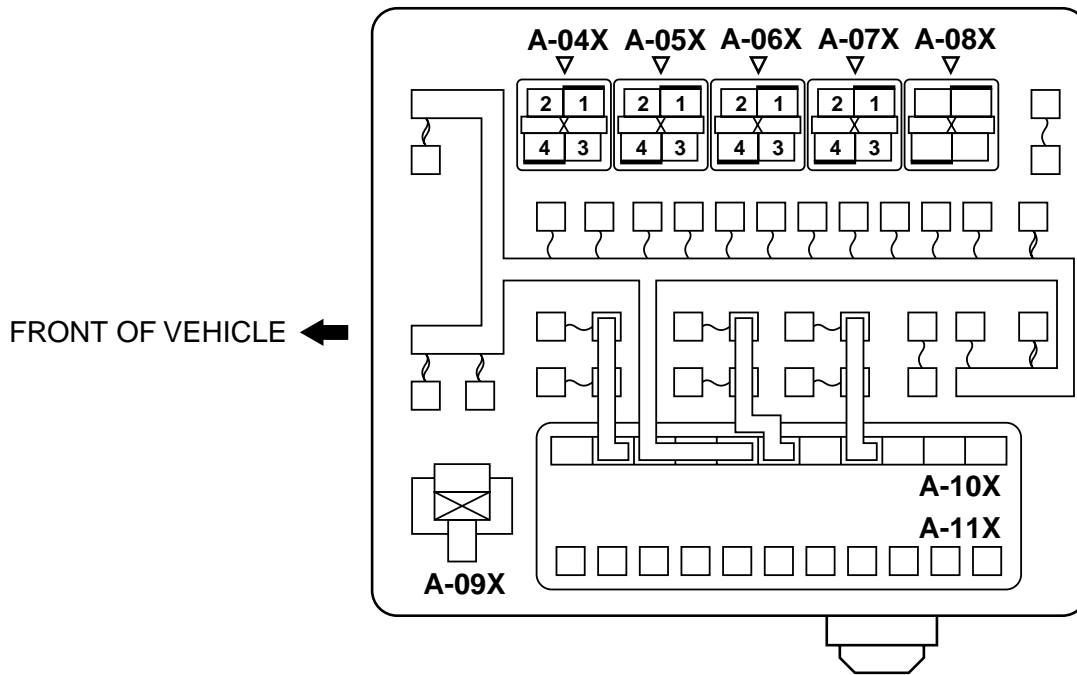

AC208462AD

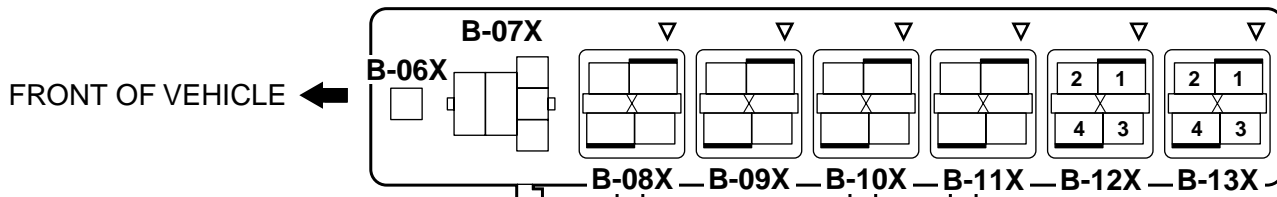

AC208464AD

NOTE:

- The terminals of the relays (A-04X to A-07X, B-11X to B-16X) are numbered when the relay box's triangle mark row is positioned above.

NOTES

POWER DISTRIBUTION SYSTEM

M1901000400589

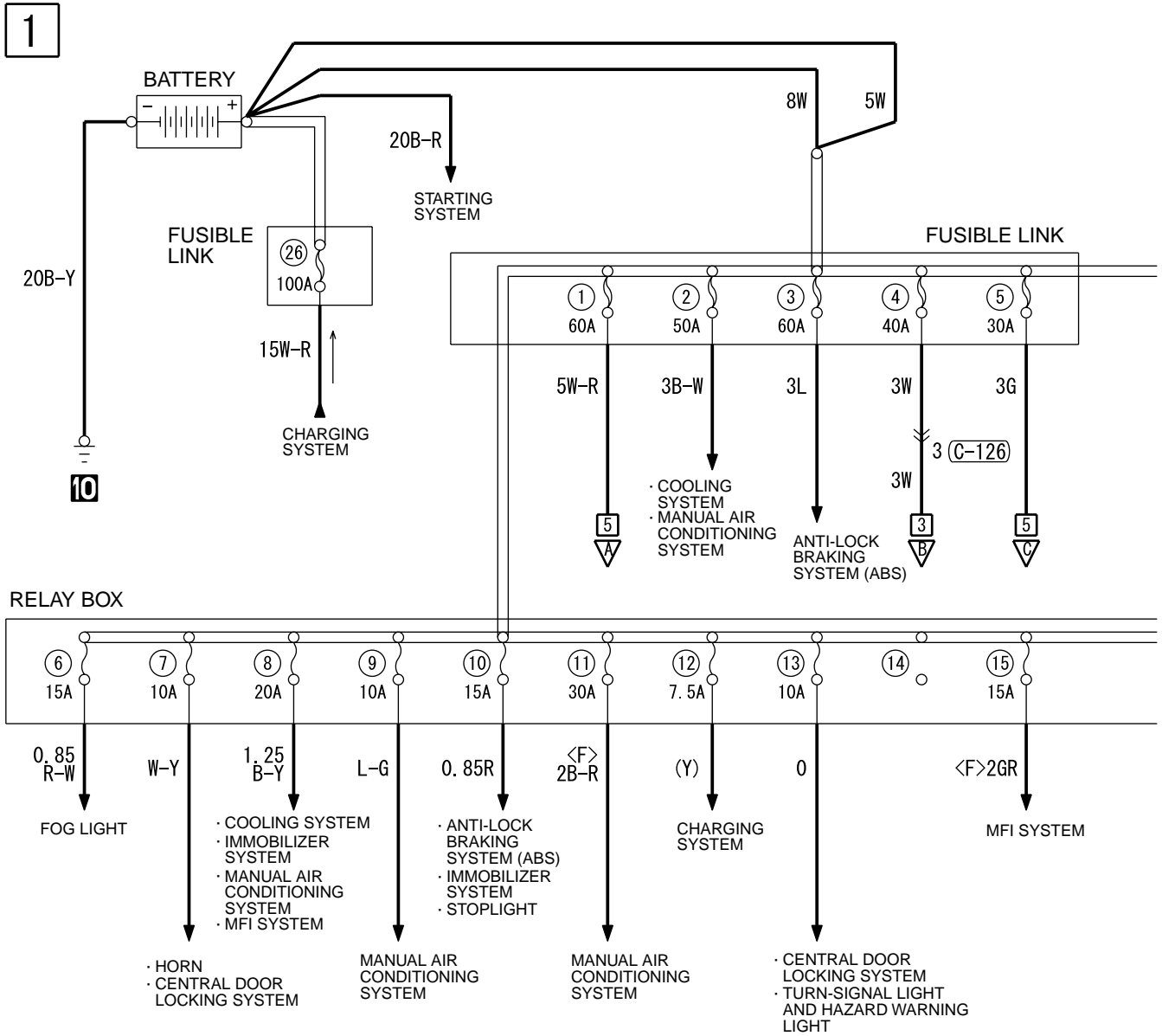

(A-10X)

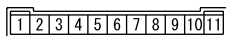

(C-126)

(MU801380)



H3J01M01AA

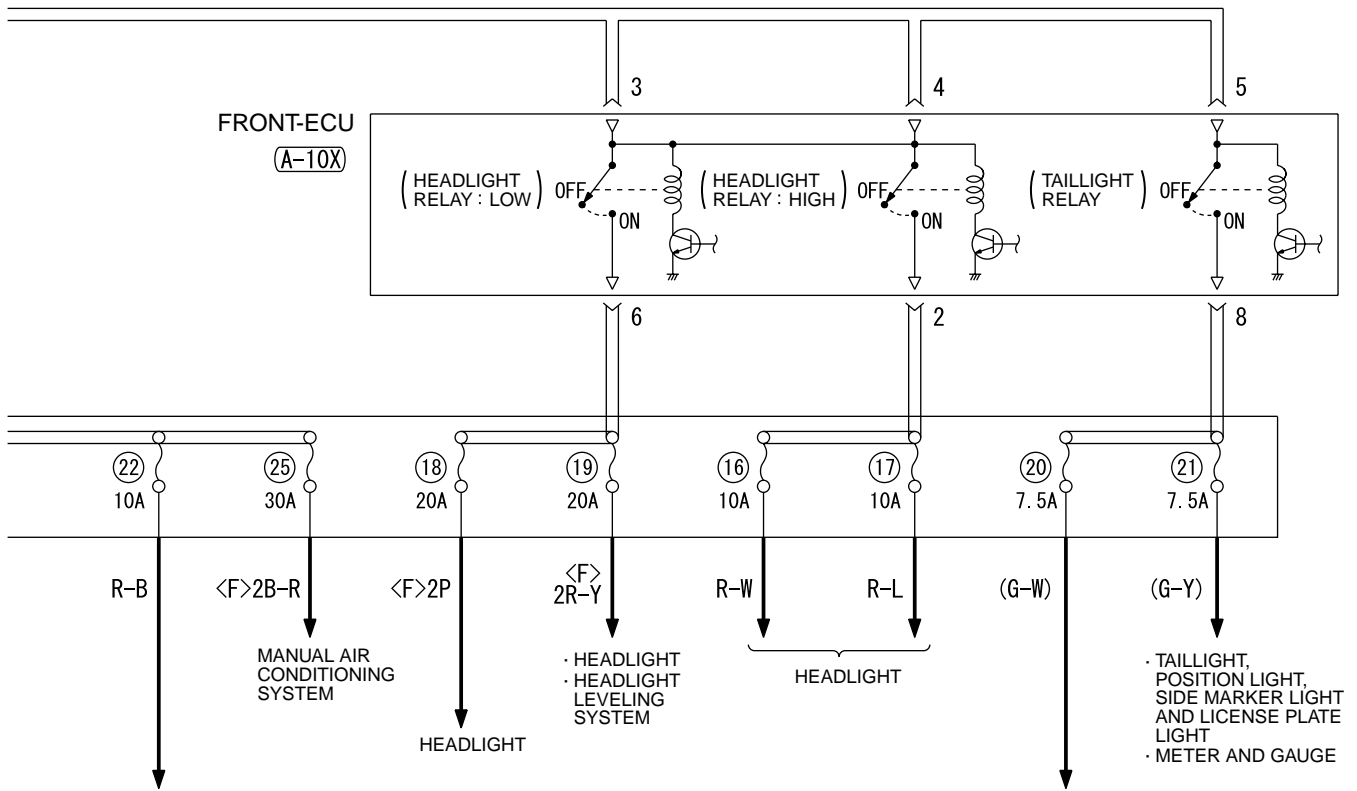

- AUDIO SYSTEM
- CENTRAL DOOR LOCKING SYSTEM
- CLOCK
- DOOR LIGHT, LUGGAGE COMPARTMENT LIGHT AND IGNITION KEY CYLINDER ILLUMINATION LIGHT
- FOG LIGHT
- FUEL WARNING LIGHT
- HEADLIGHT
- HEADLIGHT LEVELING SYSTEM
- IGNITION KEY REMINDER TONE ALARM
- LIGHTING MONITOR TONE ALARM

- METER AND GAUGE
- POWER WINDOWS
- REAR WIPER AND WASHER
- SEAT BELT TONE ALARM
- TAILLIGHT, POSITION LIGHT, SIDE MARKER LIGHT AND LICENSE PLATE LIGHT
- TURN-SIGNAL LIGHT AND HAZARD WARNING LIGHT
- WINDSHIELD WIPER AND WASHER

- AUDIO SYSTEM
- CHARGE AIR COOLER WATER SPRAY SYSTEM
- CIGARETTE LIGHTER
- CLOCK
- FOG LIGHT
- HEADLIGHT LEVELING SYSTEM
- MANUAL AIR CONDITIONING SYSTEM

- REAR WINDOW DEFOGGER
- RHEOSTAT
- TAILLIGHT, POSITION LIGHT, SIDE MARKER LIGHT AND LICENSE PLATE LIGHT
- TURN-SIGNAL LIGHT AND HAZARD WARNING LIGHT

WIRE COLOR CODE

B : BLACK LG : LIGHT GREEN G : GREEN L : BLUE W : WHITE Y : YELLOW
 SB : SKY BLUE BR : BROWN O : ORANGE GR : GRAY R : RED P : PINK V : VIOLET

POWER DISTRIBUTION SYSTEM (CONTINUED)

3

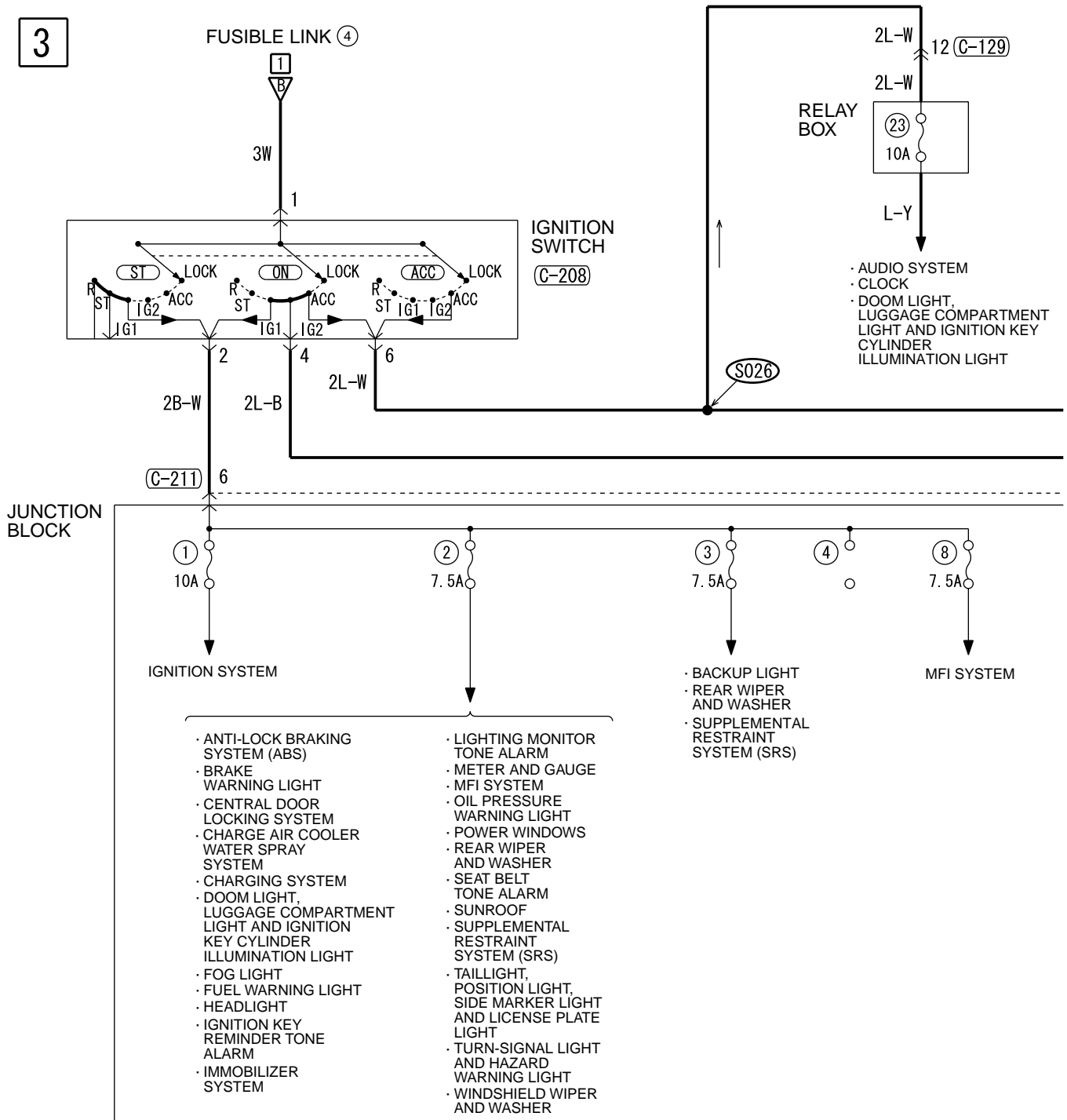

(C-129)

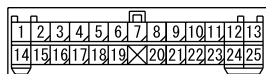

(C-208)



(C-211)



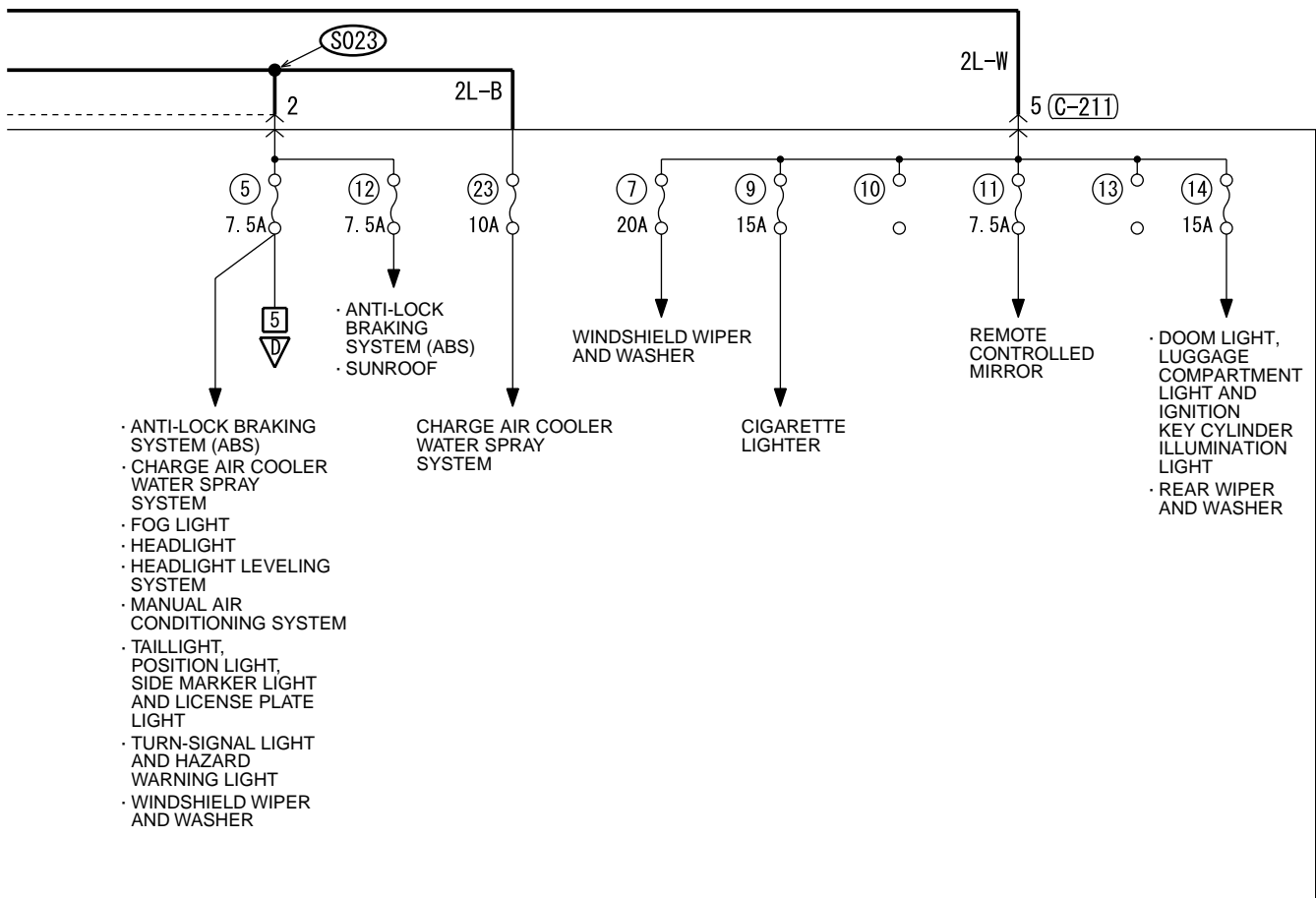

WIRE COLOR CODE

B : BLACK LG : LIGHT GREEN G : GREEN L : BLUE W : WHITE Y : YELLOW
SB : SKY BLUE BR : BROWN O : ORANGE GR : GRAY R : RED P : PINK V : VIOLET

H3J01M01BB

POWER DISTRIBUTION SYSTEM (CONTINUED)

5

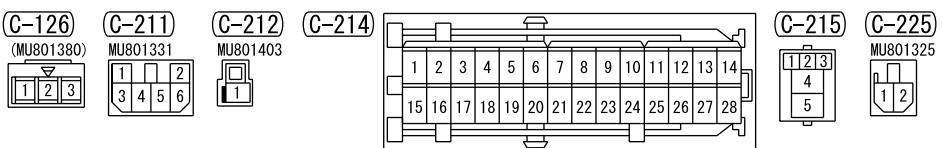
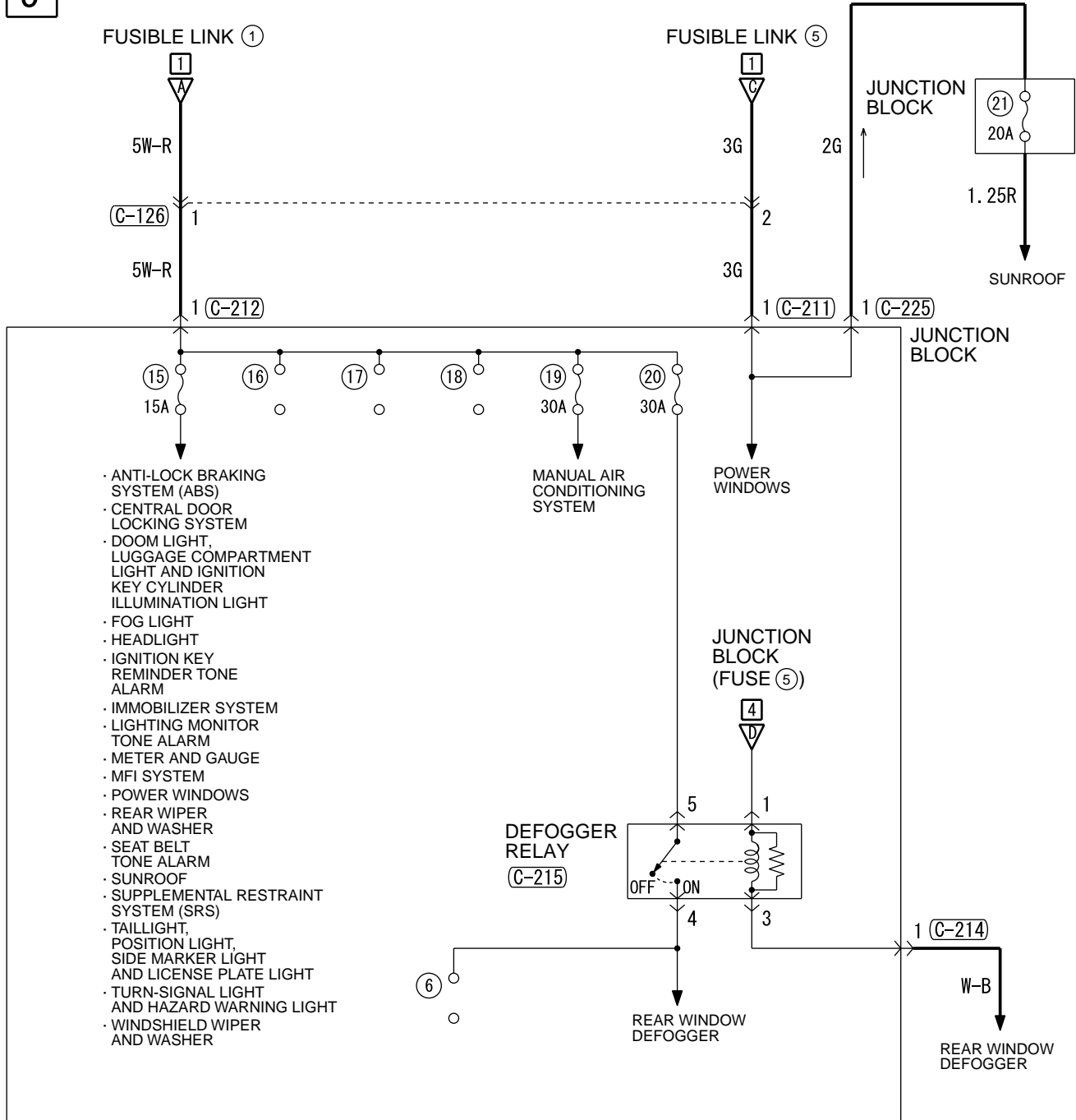

WIRE COLOR CODE
 B : BLACK LG : LIGHT GREEN G : GREEN L : BLUE W : WHITE Y : YELLOW
 SB : SKY BLUE BR : BROWN O : ORANGE GR : GRAY R : RED P : PINK V : VIOLET

TSB Revision

STARTING SYSTEM

M1901000500779

1

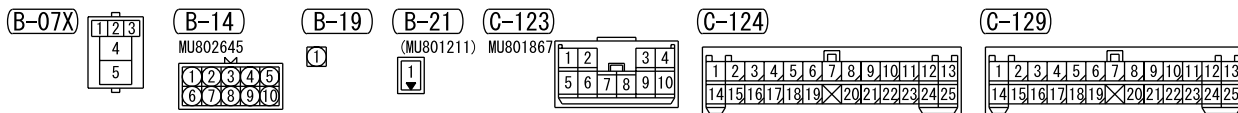
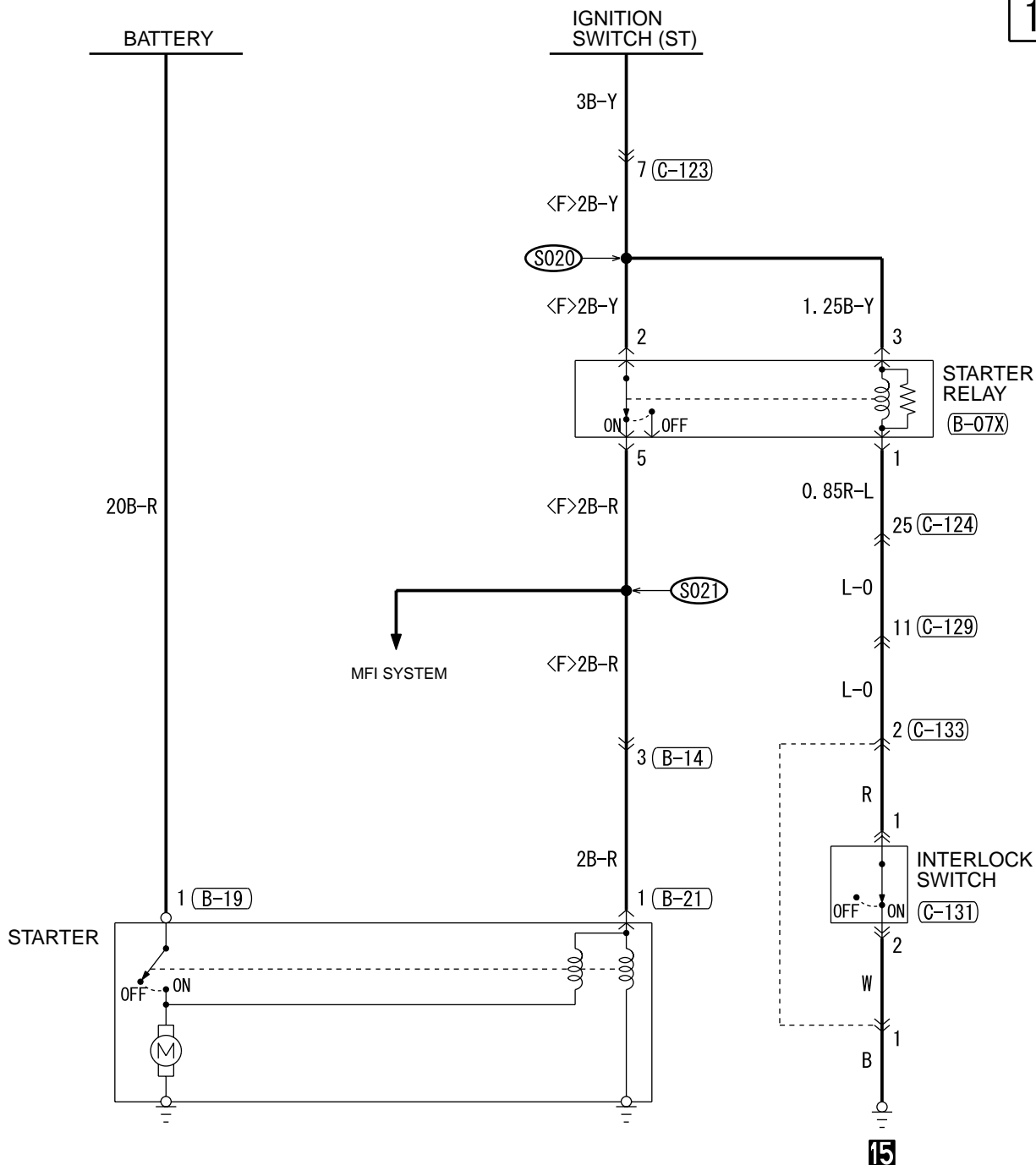

(C-131) MU801325
(C-133) MU801325

WIRE COLOR CODE
 B : BLACK LG : LIGHT GREEN G : GREEN L : BLUE W : WHITE Y : YELLOW
 SB : SKY BLUE BR : BROWN O : ORANGE GR : GRAY R : RED P : PINK V : VIOLET

H3J02M03AA

TSB Revision

IGNITION SYSTEM

1

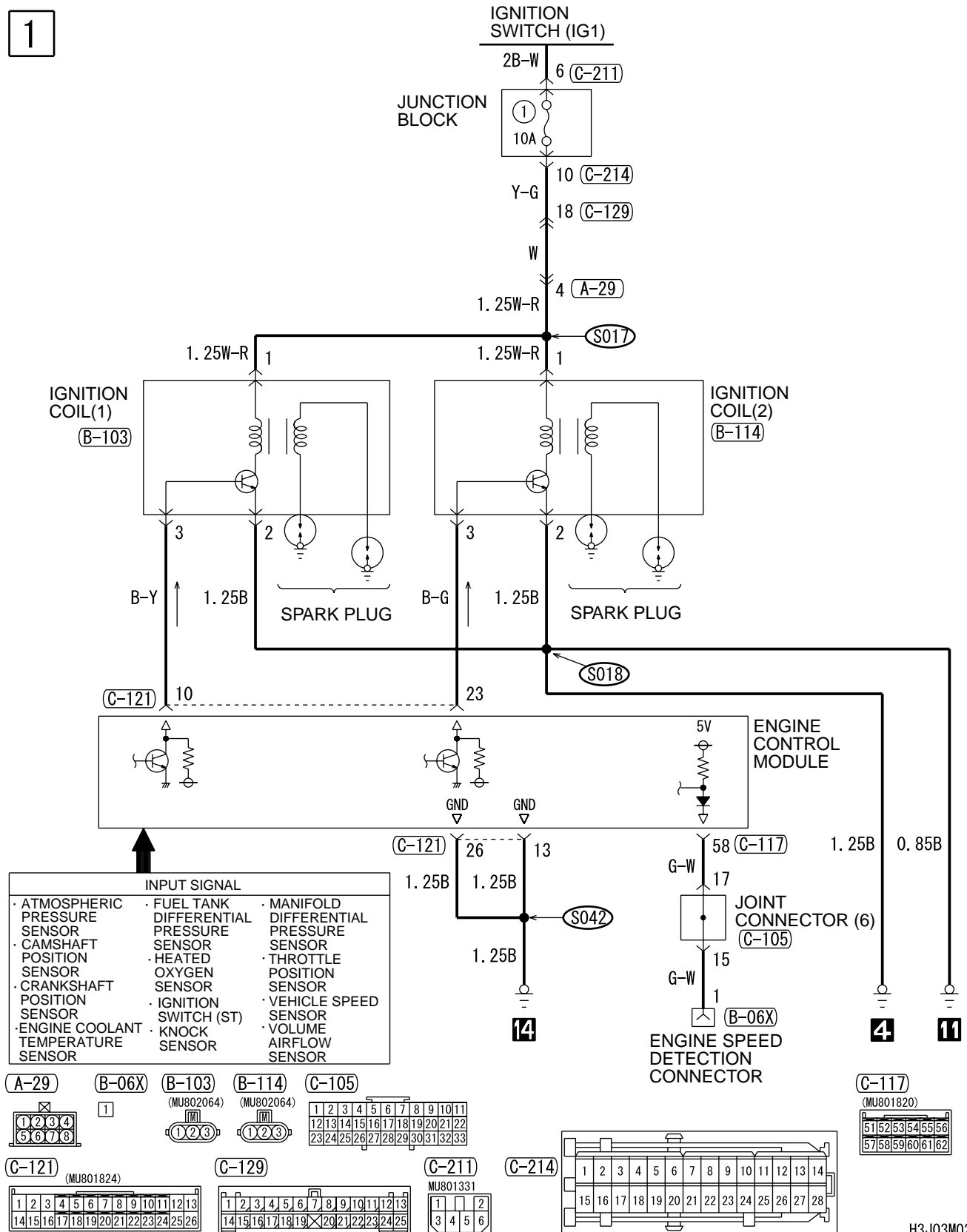

CHARGING SYSTEM

M1901000700676

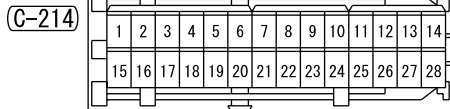
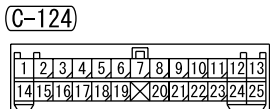
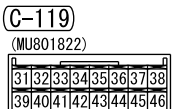
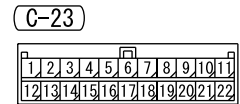
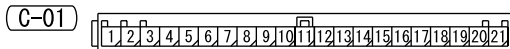
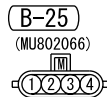
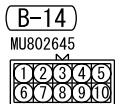
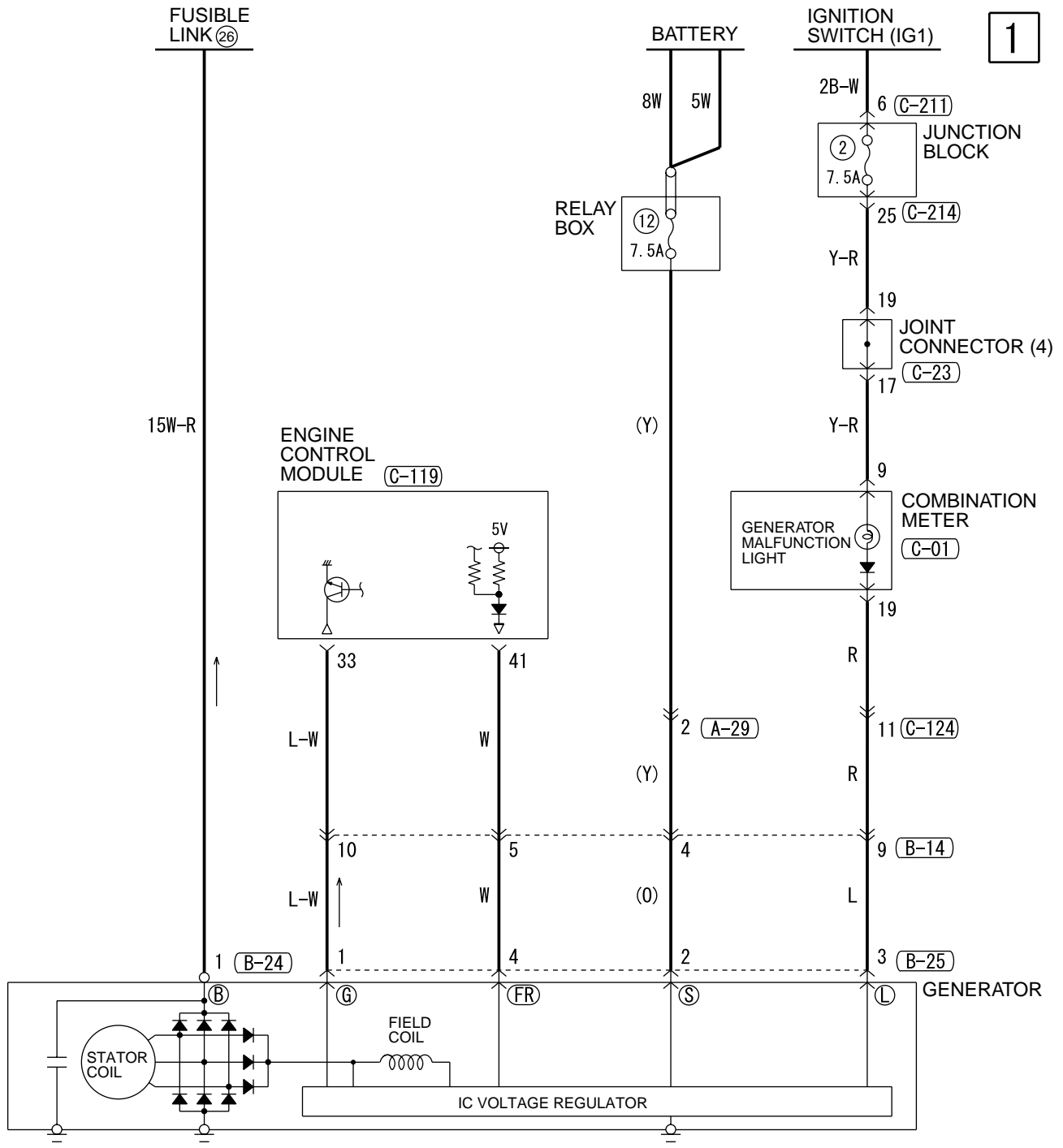

H3J04M00AA

MFI SYSTEM

M1901000801223

1

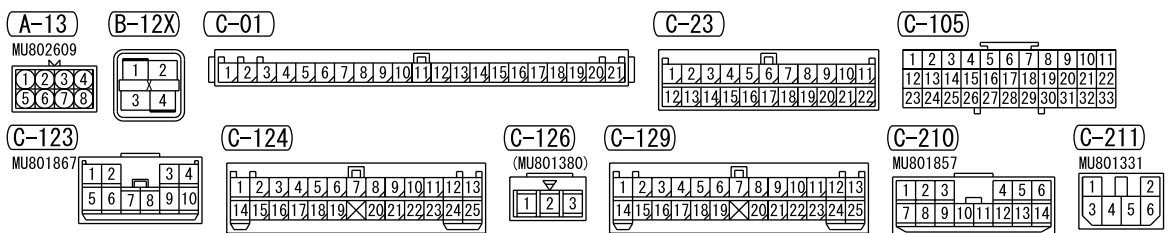
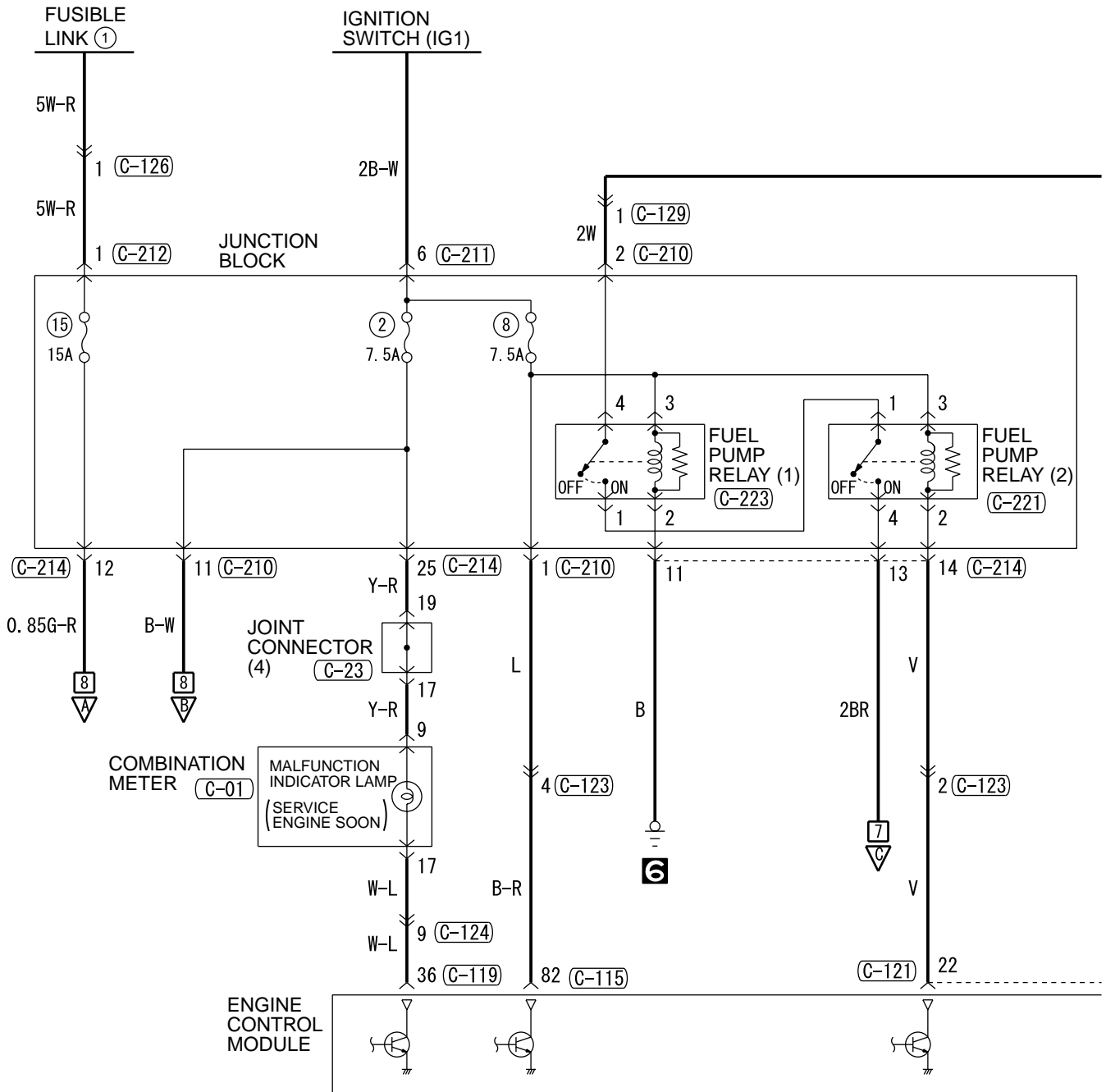

H3J05M06AA

TSB Revision

2

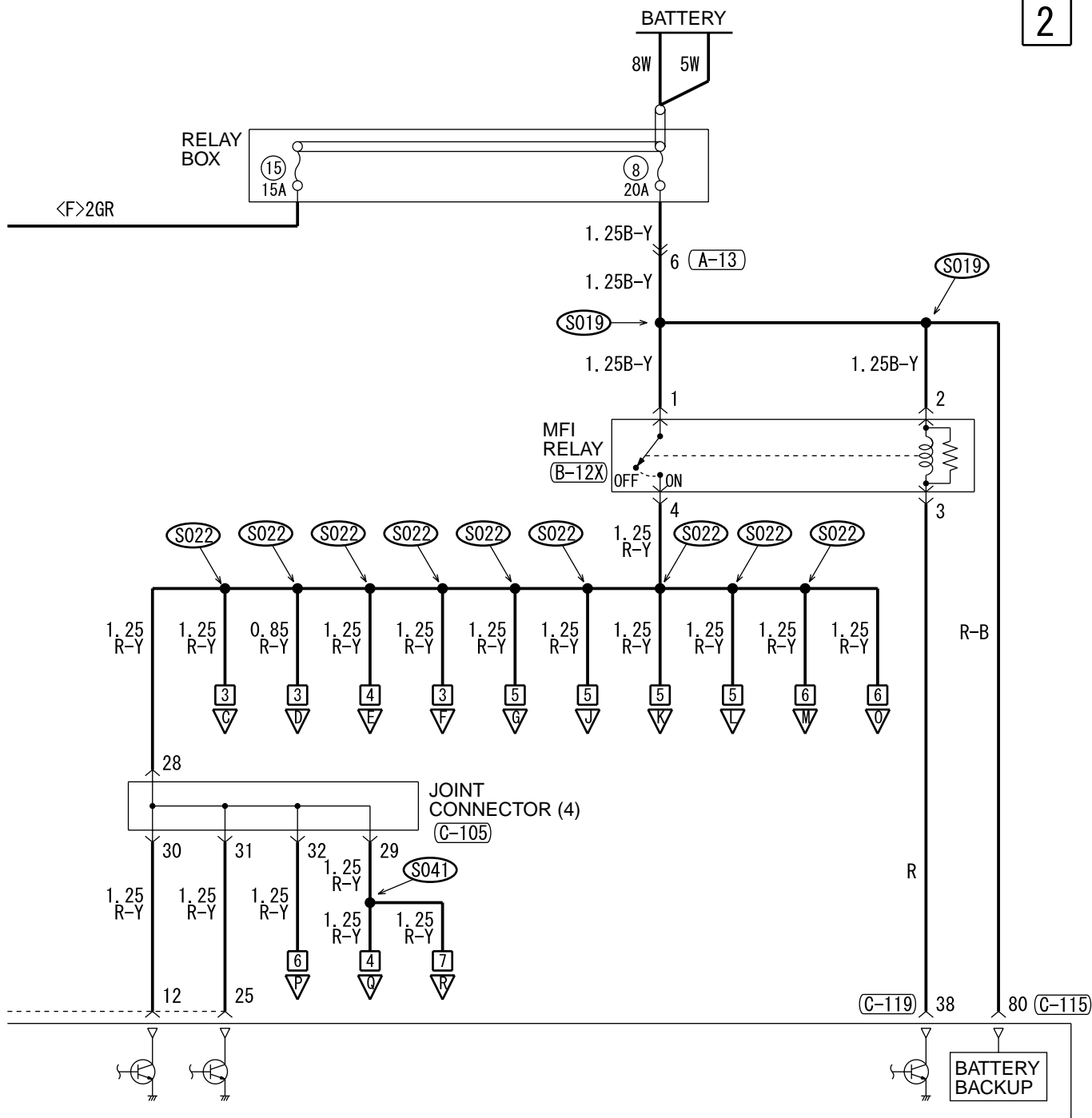

C-214

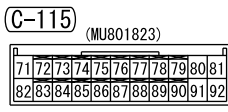
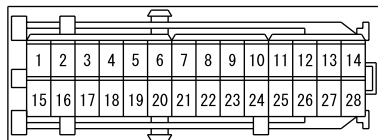

C-221 C-223

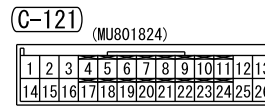
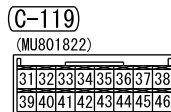
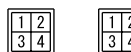

MFI SYSTEM (CONTINUED)

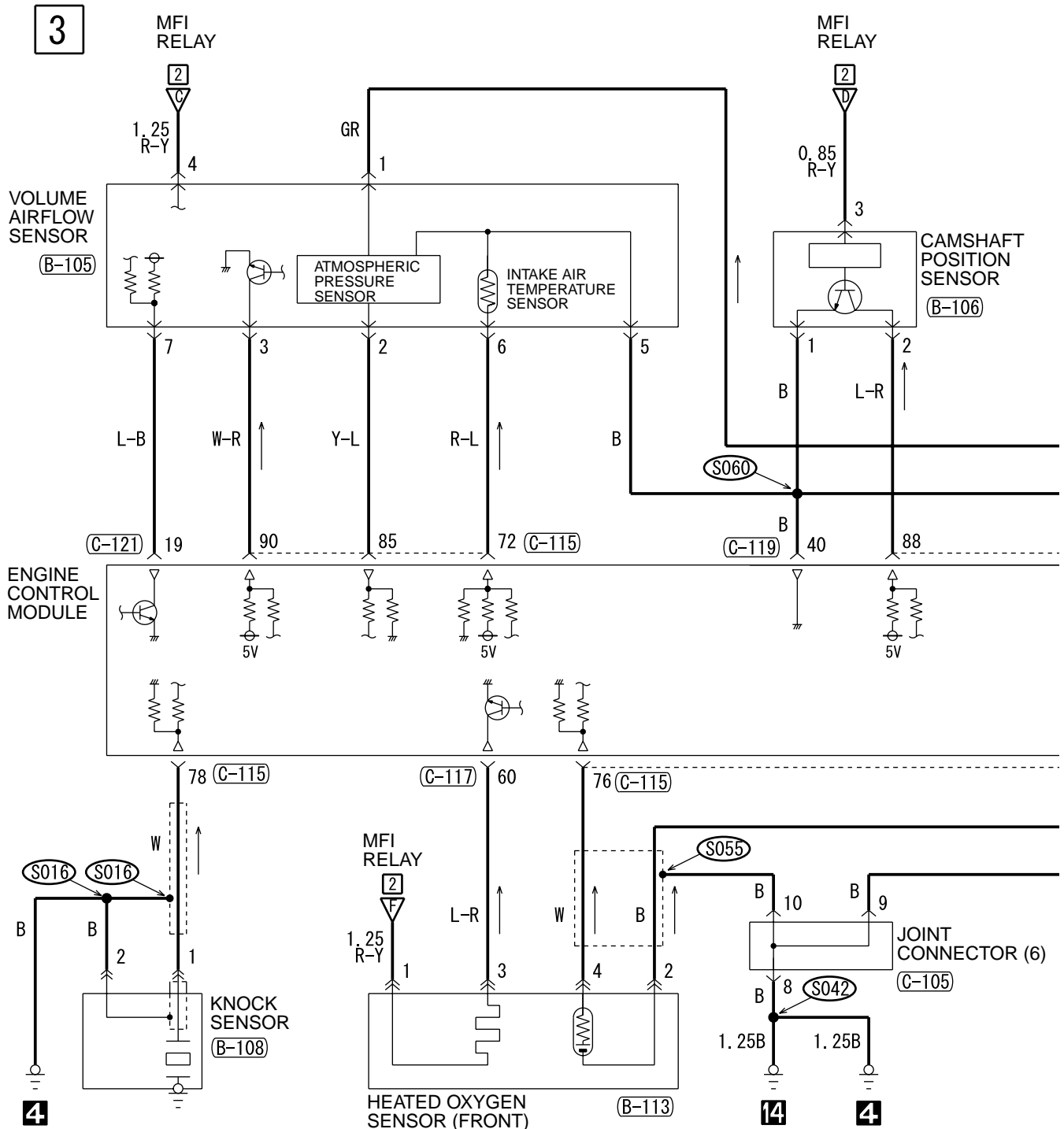

- (B-03)
(MU802724)
- (B-102)
(MU802723)
- (B-105)
(MU802552)
- (B-106)
(MU802337)
- (B-107)
(MU802406)
- (B-108)
(MU802661)
- (B-113)
(MU802605)
- (B-117)
(MU802603)
- (C-105)
- (C-122)
- (D-09)
(MU802723)
- (D-35)
(MU801697)
- (D-40)
(MU801446)

4

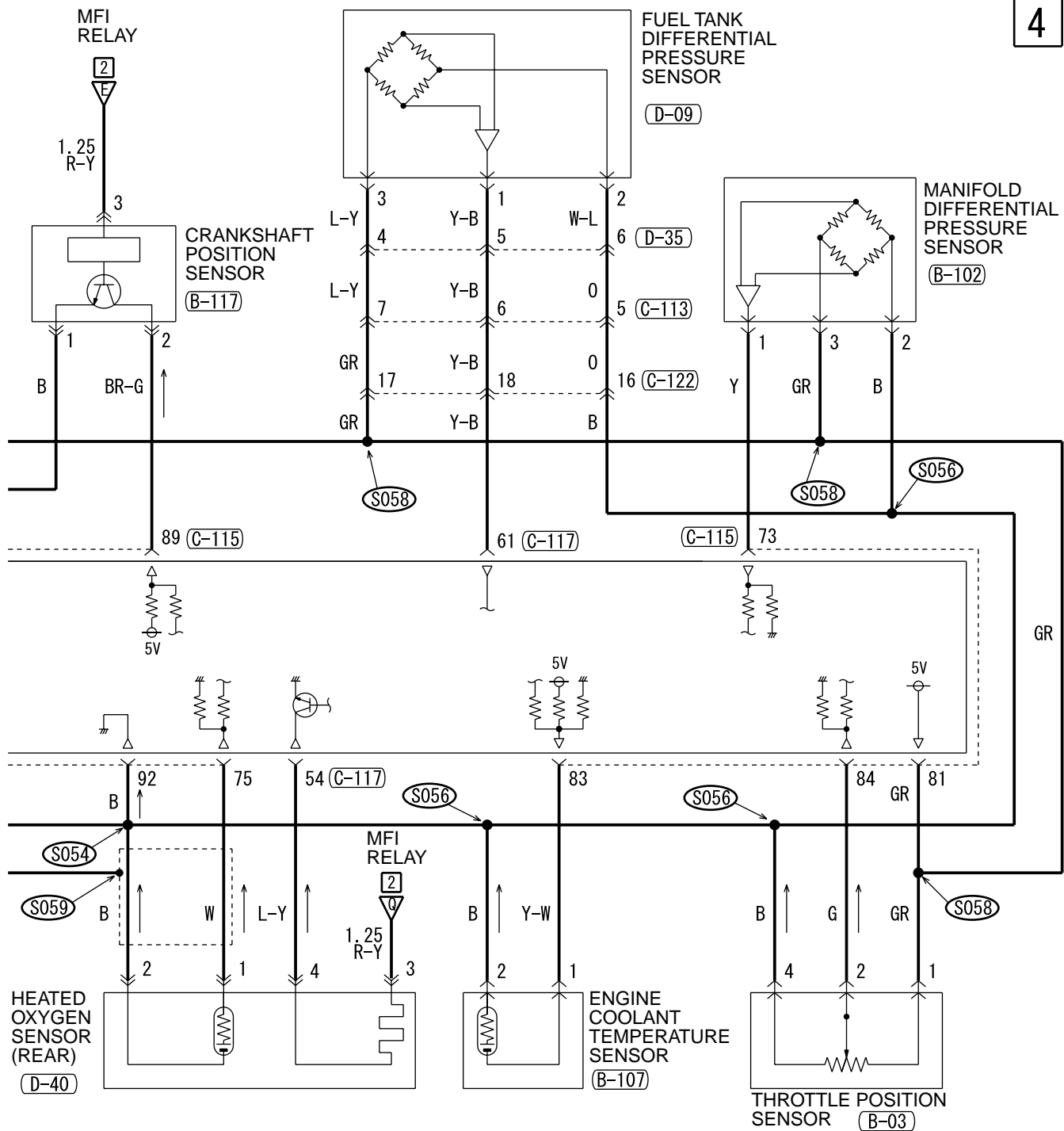

C-113

1	2	3	4	5	6	7	8	9	10	11	12	13
14	15	16	17	18	19	20	21	22	23	24	25	

C-115

(MU801823)

71	72	73	74	75	76	77	78	79	80	81
82	83	84	85	86	87	88	89	90	91	92

C-117

(MU801820)

51	52	53	54	55	56
57	58	59	60	61	62

C-119

(MU801822)

31	32	33	34	35	36	37	38
39	40	41	42	43	44	45	46

C-121

(MU801824)

1	2	3	4	5	6	7	8	9	10	11	12	13
14	15	16	17	18	19	20	21	22	23	24	25	26

MFI SYSTEM (CONTINUED)

5

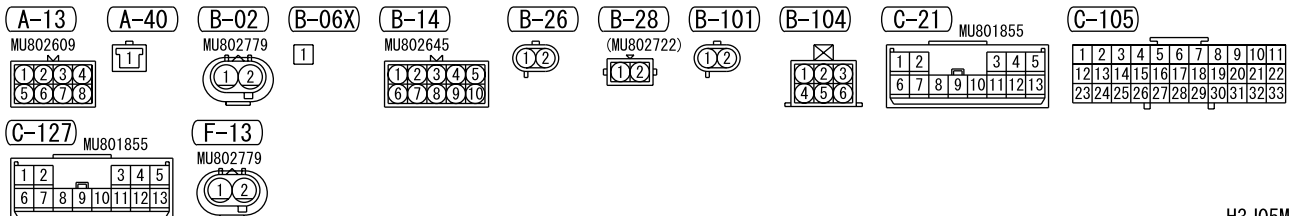
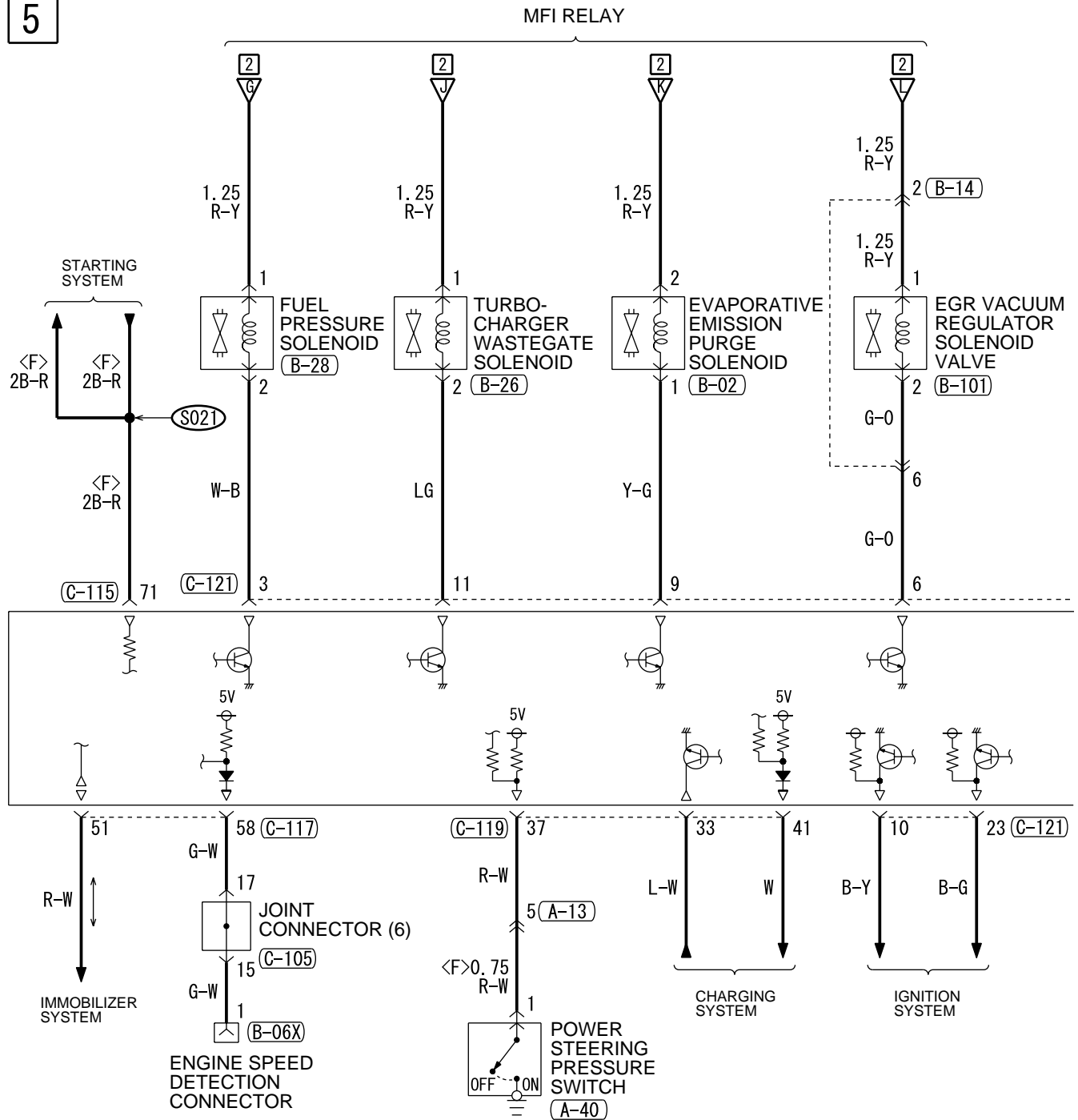

6

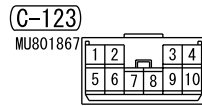
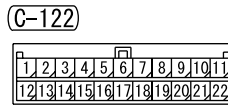
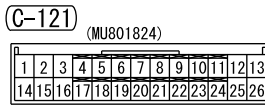
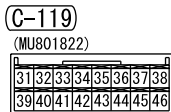
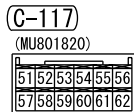
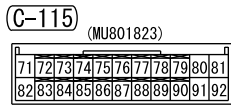
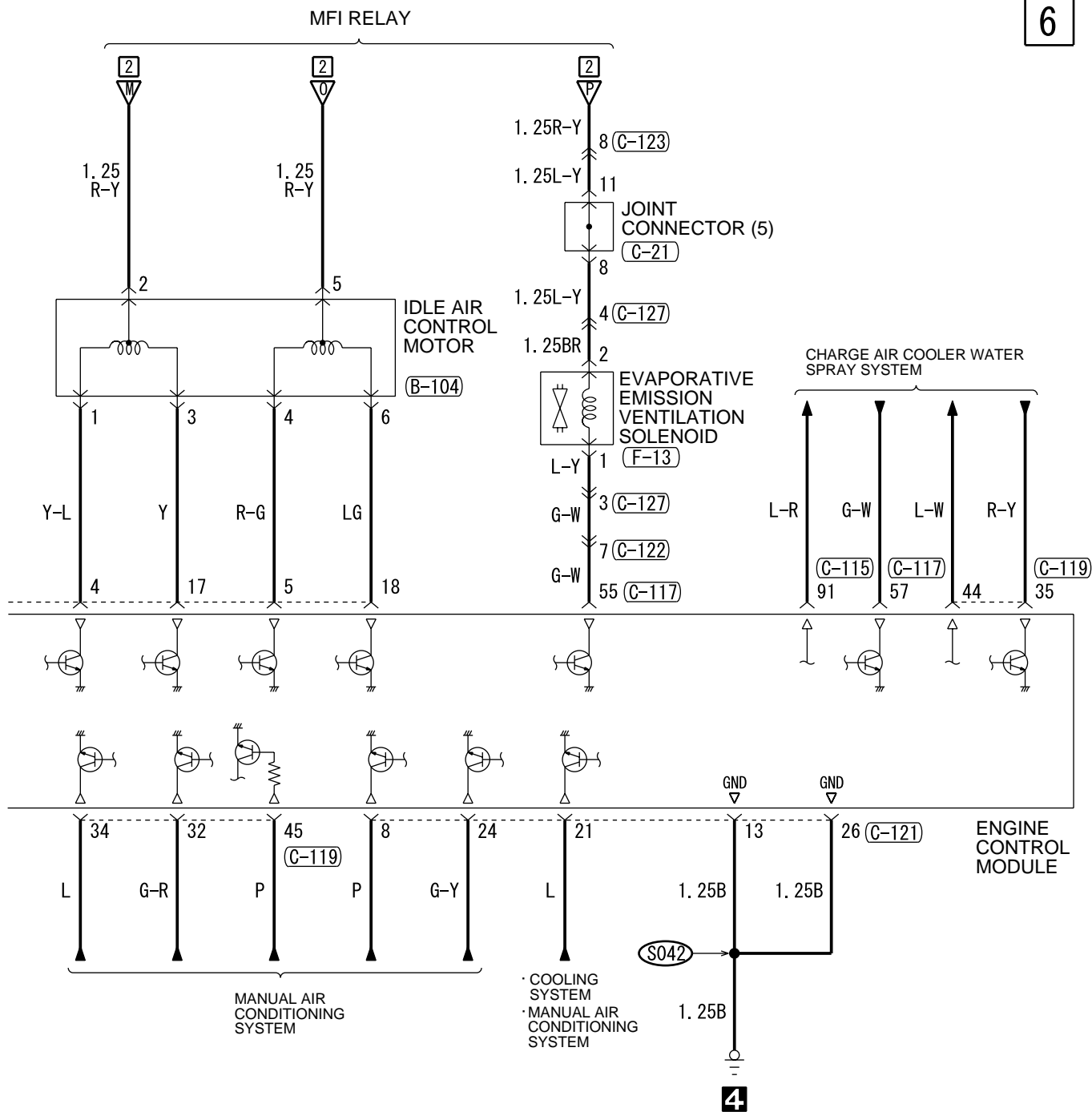

MFI SYSTEM (CONTINUED)

7

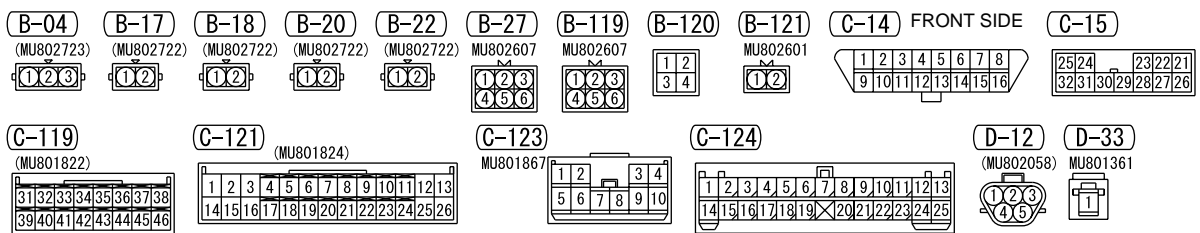
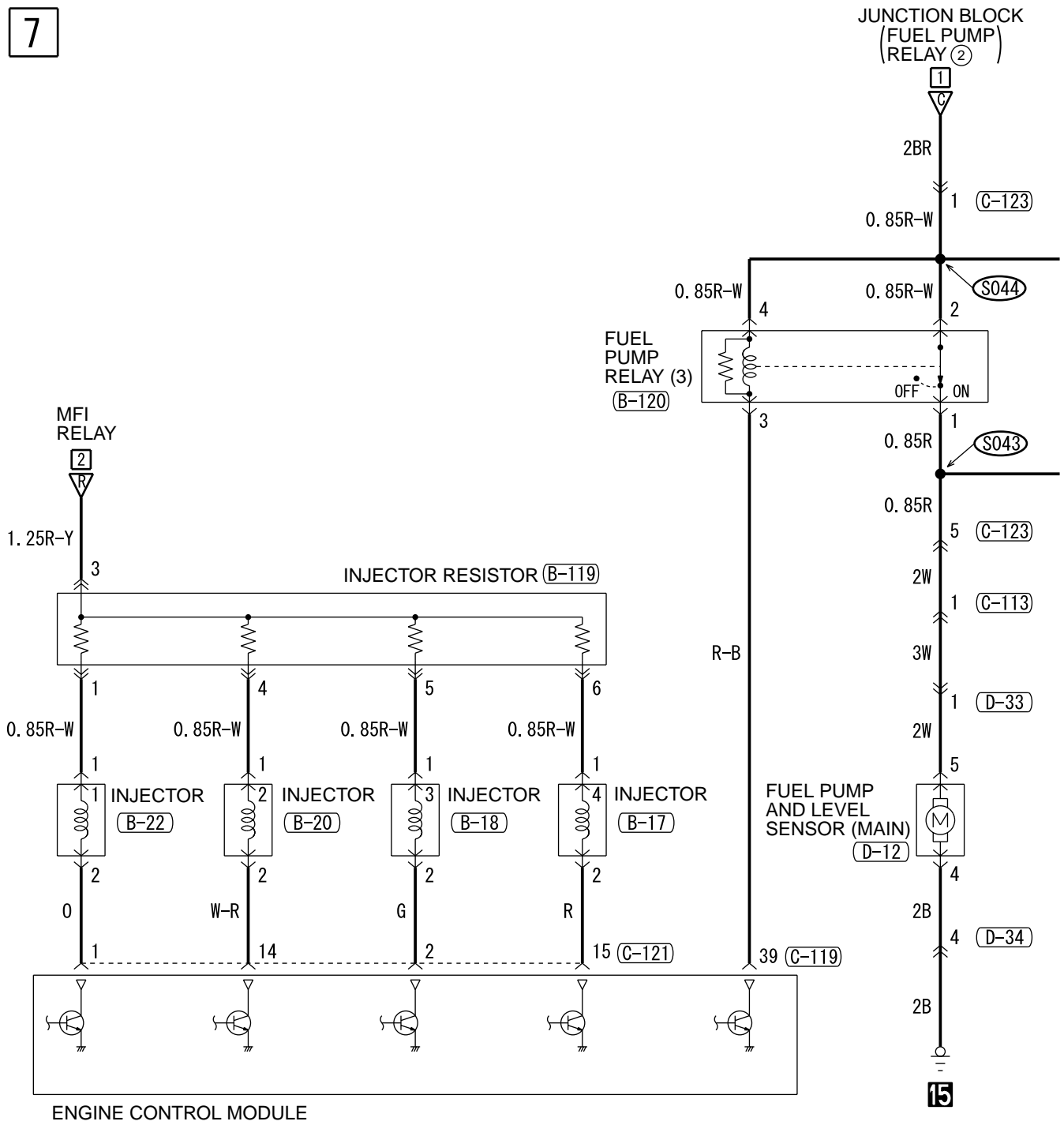

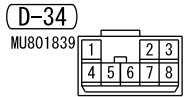
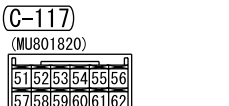
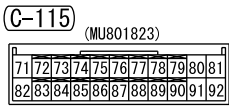
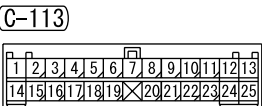
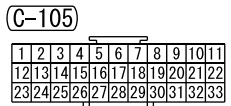
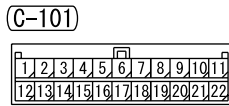
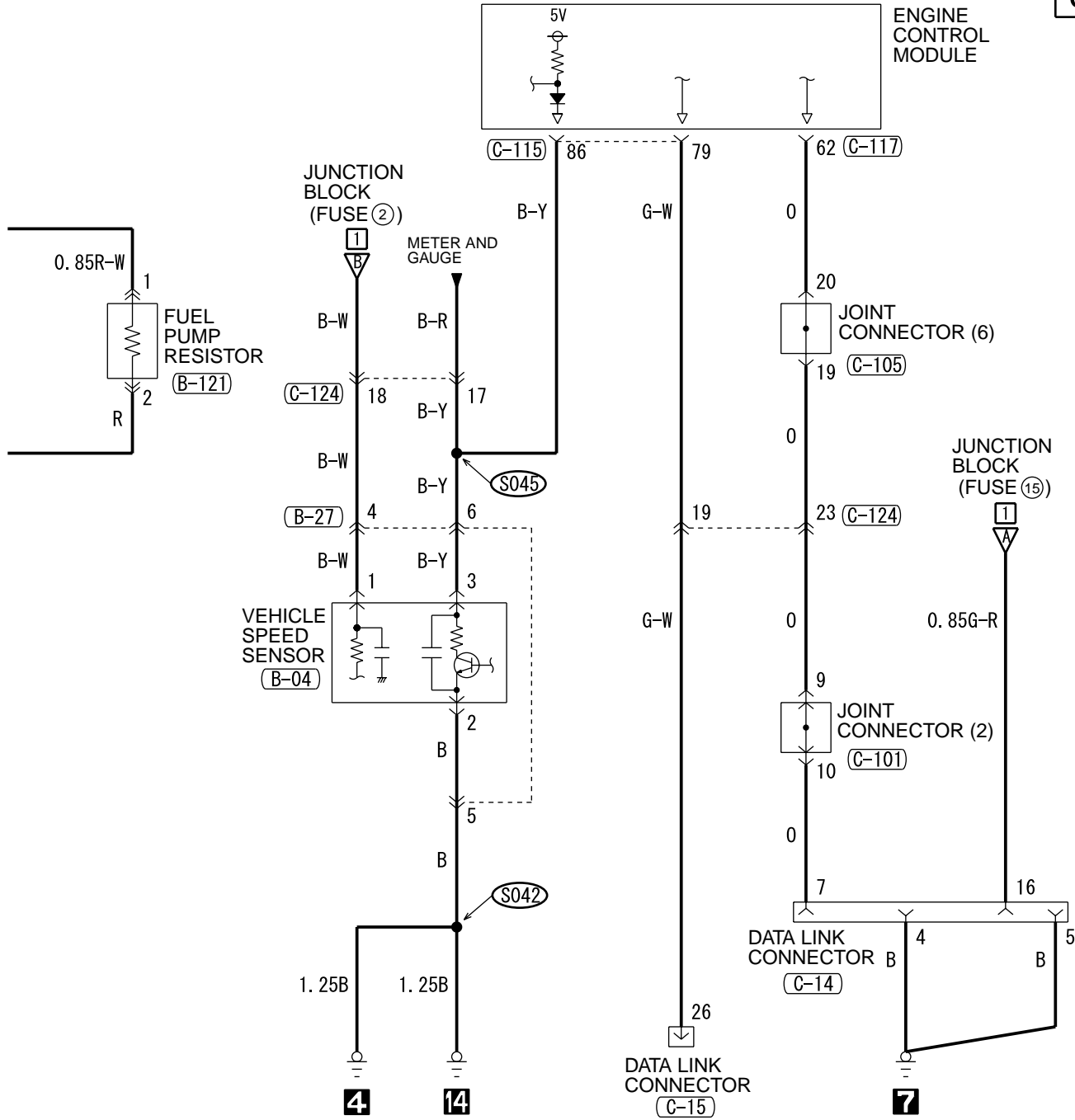

WIRE COLOR CODE
 B : BLACK LG : LIGHT GREEN G : GREEN L : BLUE W : WHITE Y : YELLOW
 SB : SKY BLUE BR : BROWN O : ORANGE GR : GRAY R : RED P : PINK V : VIOLET

H3J05M06DB

NOTES

COOLING SYSTEM

M1901001000443

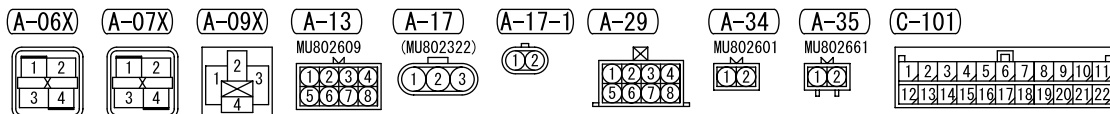
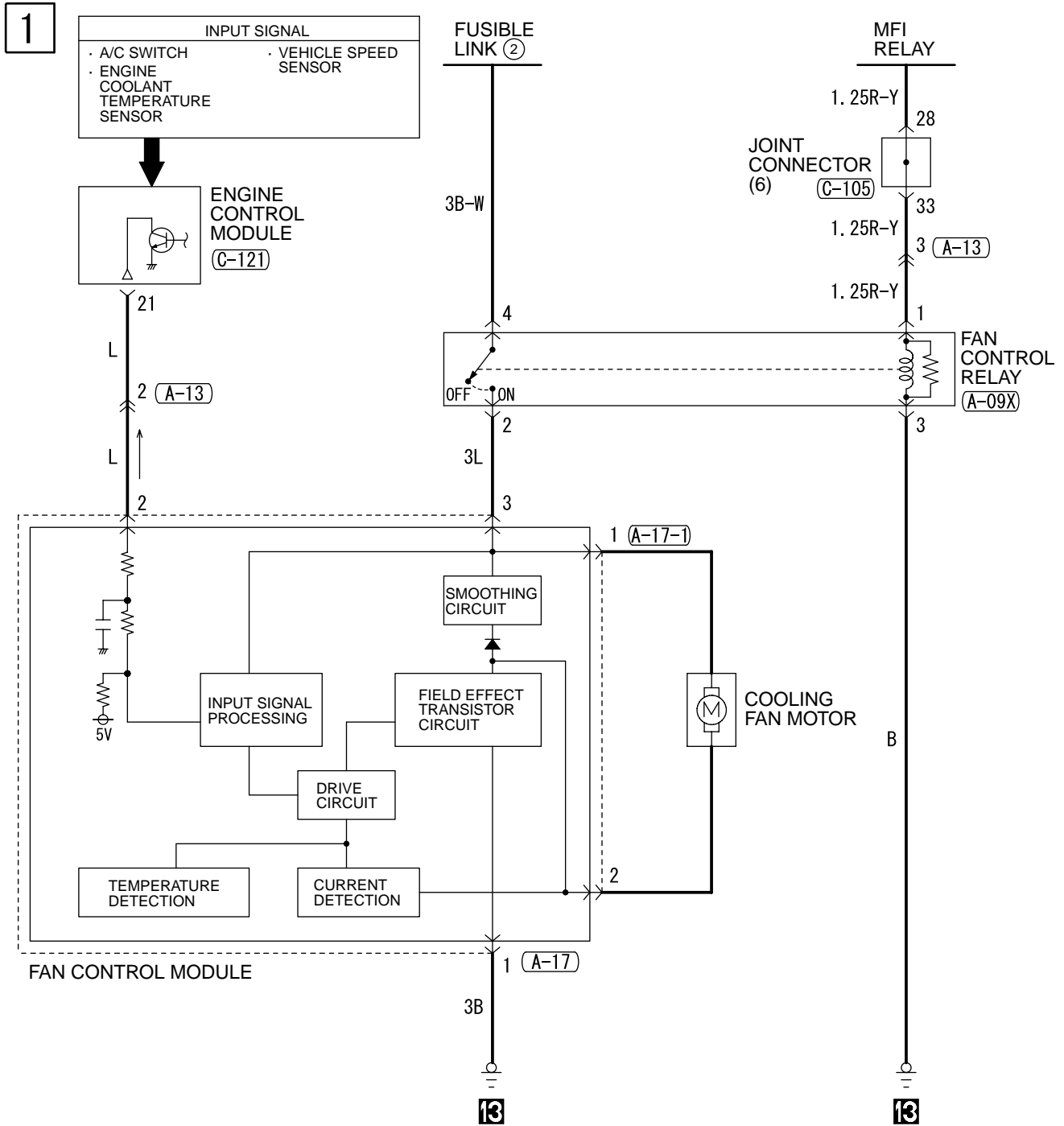

2

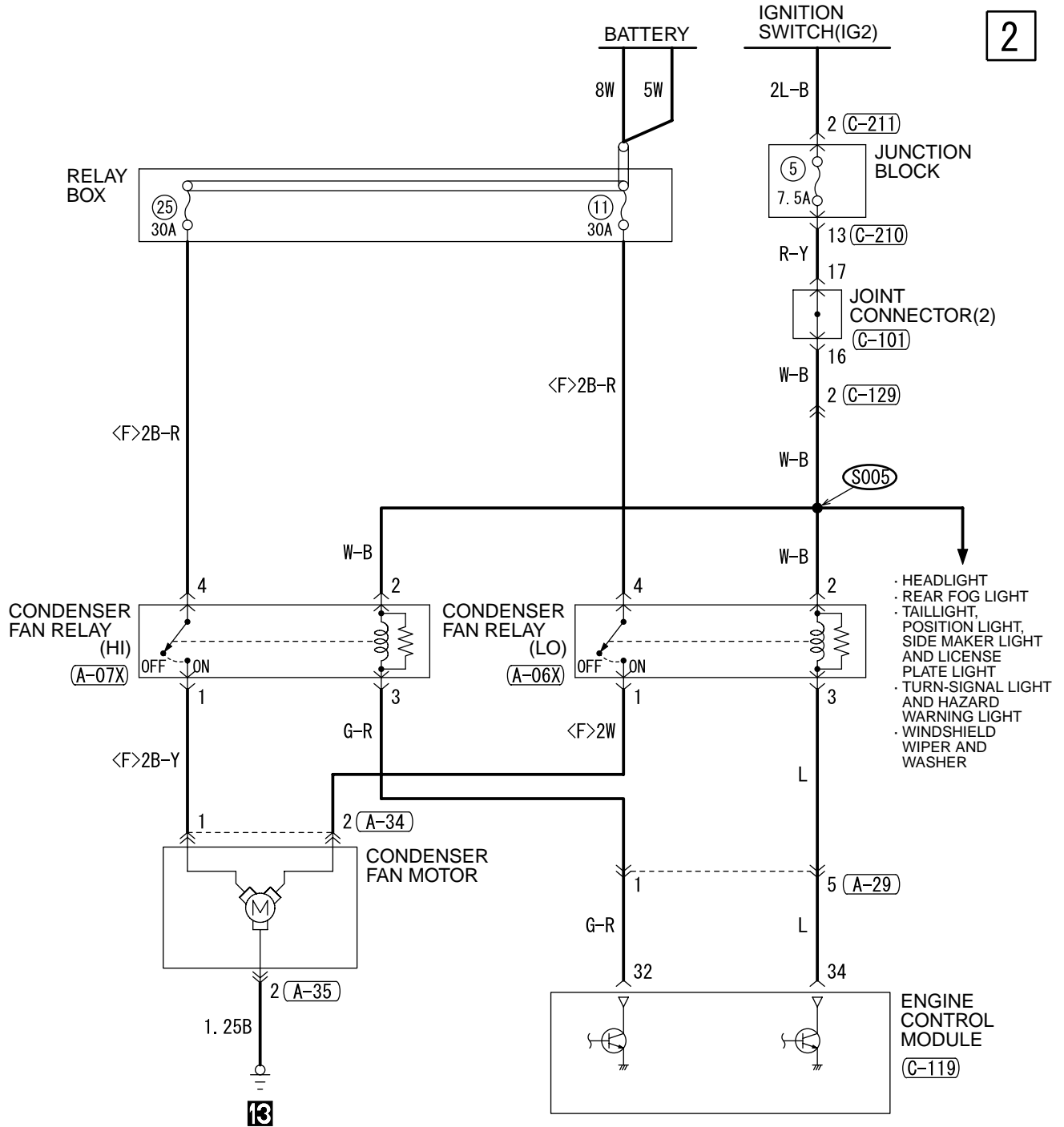

(C-105)

1	2	3	4	5	6	7	8	9	10	11
12	13	14	15	16	17	18	19	20	21	22
23	24	25	26	27	28	29	30	31	32	33

(C-119)

31	32	33	34	35	36	37	38
39	40	41	42	43	44	45	46

(C-121)

1	2	3	4	5	6	7	8	9	10	11	12	13
14	15	16	17	18	19	20	21	22	23	24	25	26

(C-129)

1	2	3	4	5	6	7	8	9	10	11	12	13	14	15	16	17	18	19	20	21	22	23	24	25
---	---	---	---	---	---	---	---	---	----	----	----	----	----	----	----	----	----	----	----	----	----	----	----	----

(C-210)

1	2	3	4	5	6		
7	8	9	10	11	12	13	14

(C-211)

1	2		
3	4	5	6

WIRE COLOR CODE
B : BLACK LG : LIGHT GREEN G : GREEN L : BLUE W : WHITE Y : YELLOW

HEADLIGHT

1

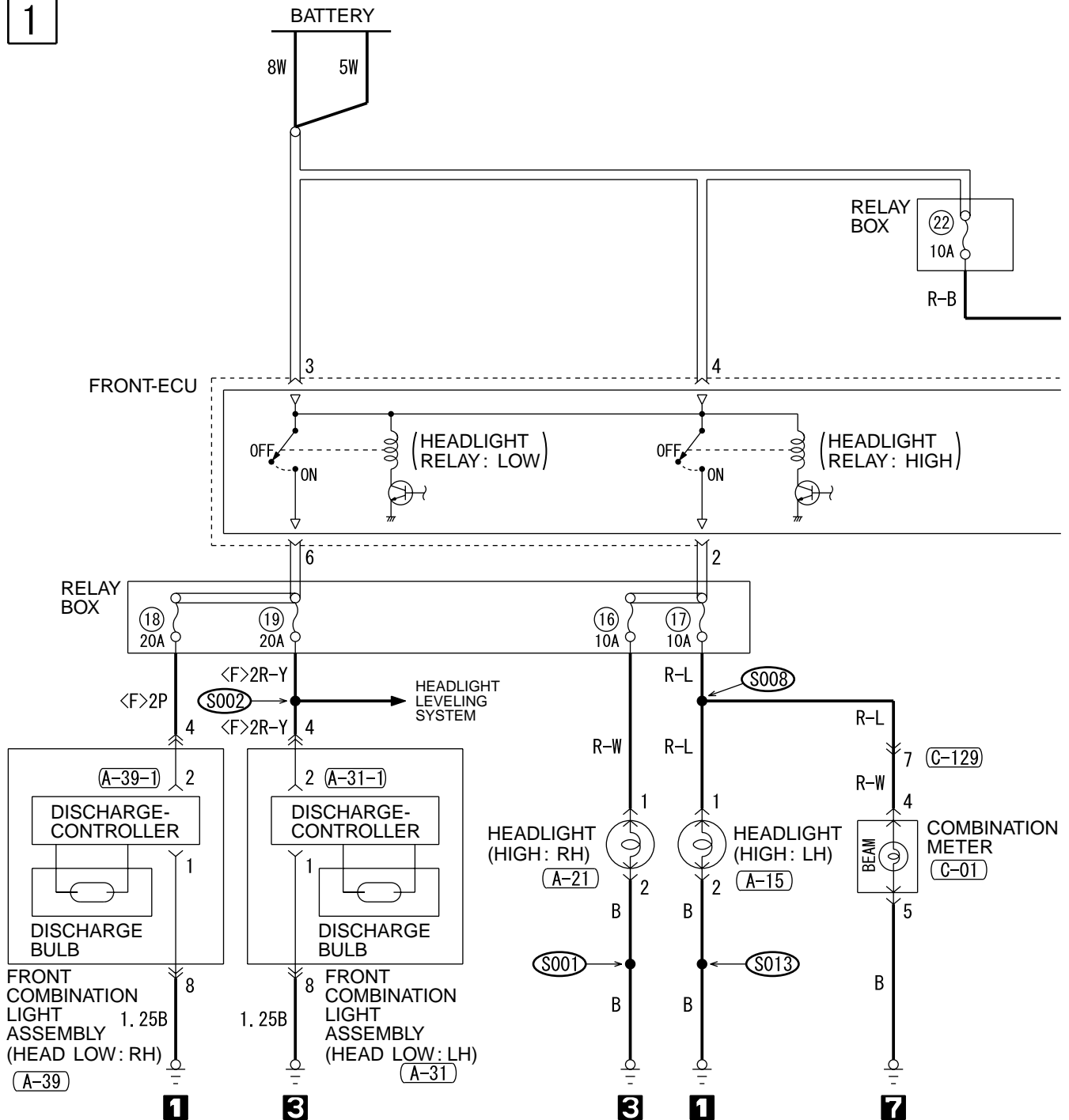

(A-10X)

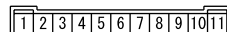

(A-11X)

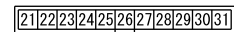

(A-15)



(A-21)



(A-31)



(A-31-1)



(A-39)



(A-39-1)



(C-101)

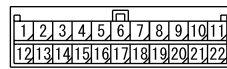

(C-129)

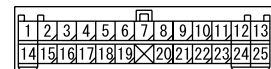

(C-206)



(C-210)

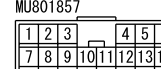

(C-211)



2

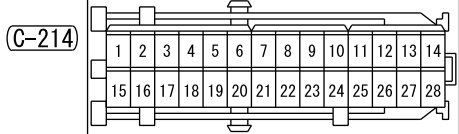
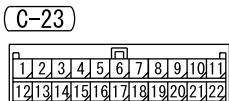
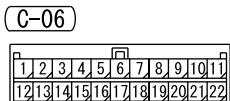
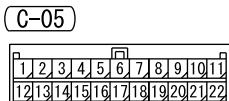
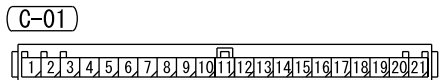
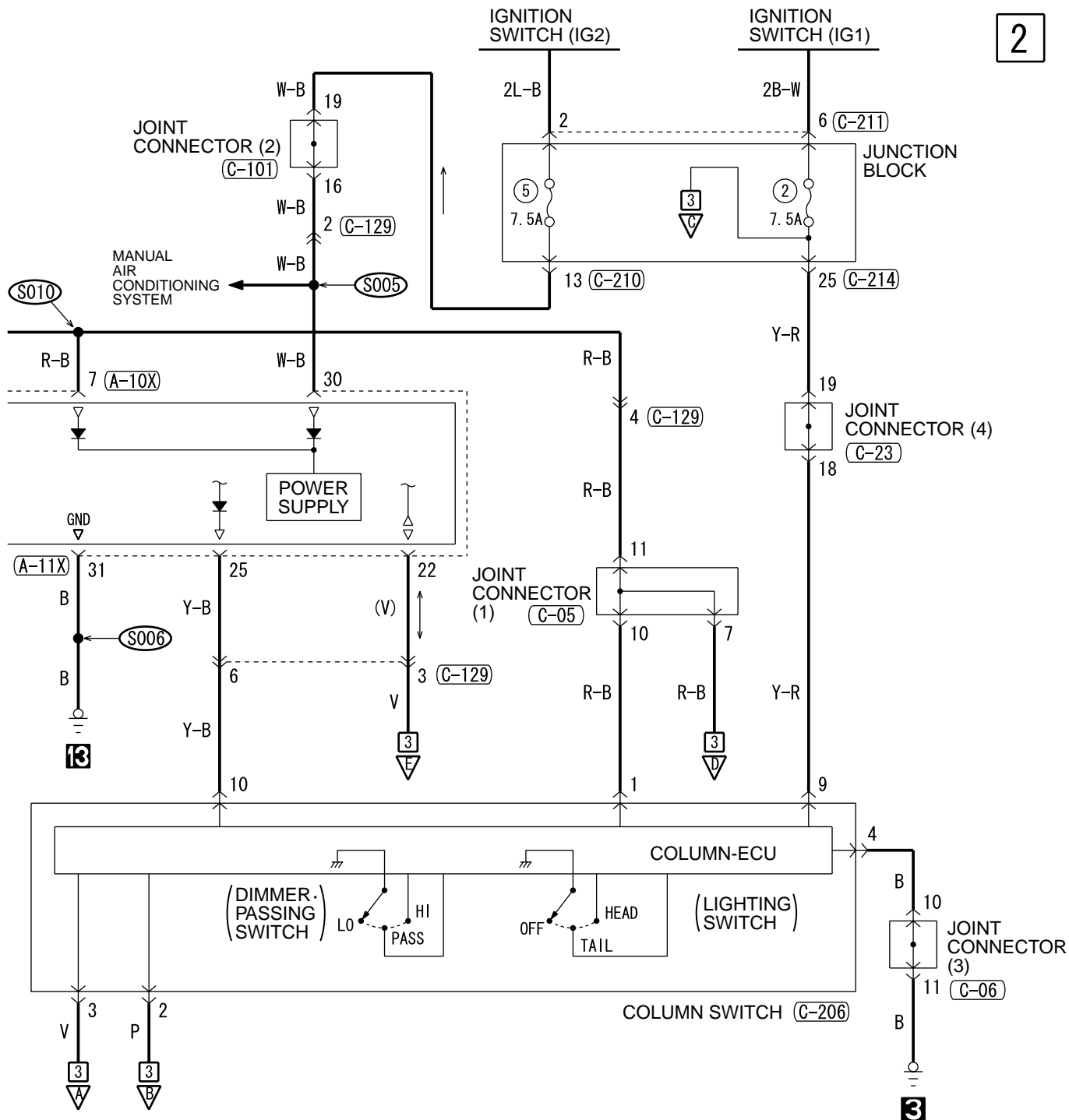

WIRE COLOR CODE
 B : BLACK LG : LIGHT GREEN G : GREEN L : BLUE
 BR : BROWN O : ORANGE GR : GRAY R : RED W : WHITE
 SB : SKY BLUE P : PINK Y : YELLOW V : VIOLET

H3J08M04AB

TSB Revision

NOTES

HEADLIGHT LEVELING SYSTEM

M1901012500033

1

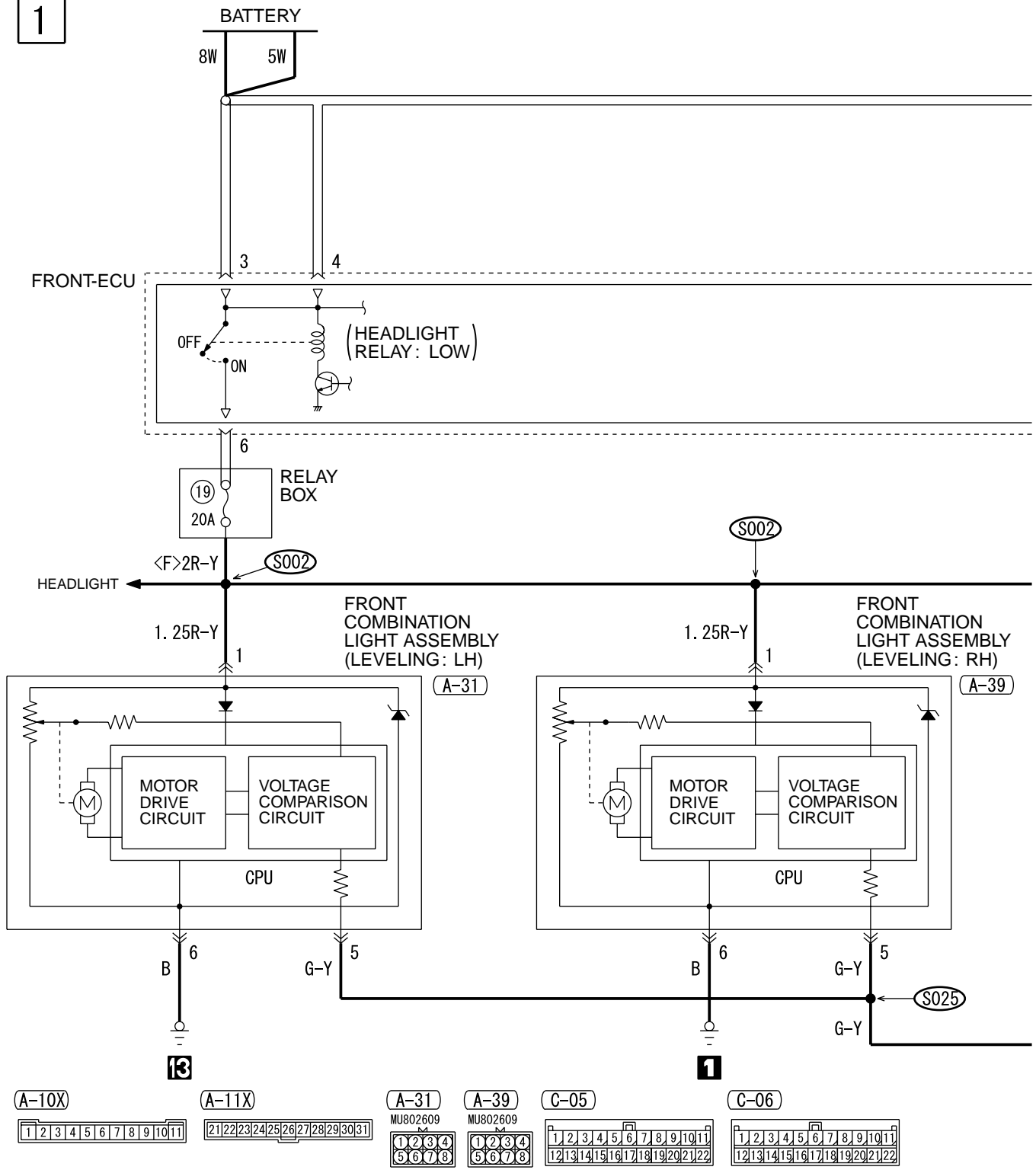

H3J08M05AA

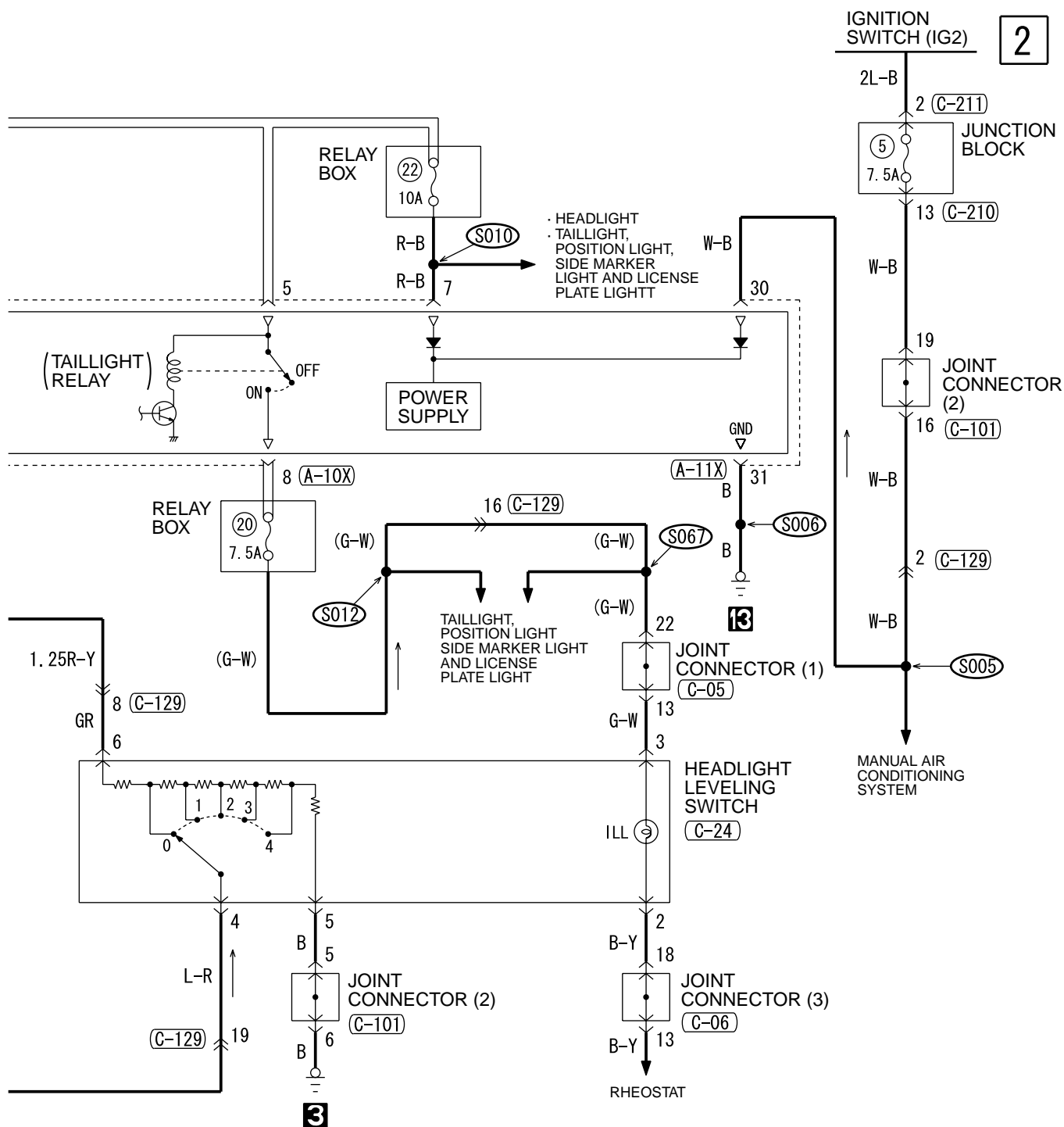

(C-24)

(C-101)

(C-129)

(C-210)

(C-211)

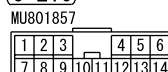
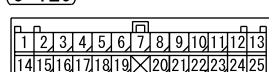
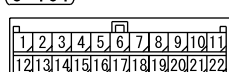
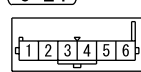

WIRE COLOR CODE

B: BLACK LG: LIGHT GREEN G: GREEN L: BLUE W: WHITE Y: YELLOW
SB: SKY BLUE BR: BROWN O: ORANGE GR: GRAY R: RED P: PINK V: VIOLET

TAILLIGHT, POSITION LIGHT, SIDE MARKER LIGHT AND LICENSE PLATE LIGHT

M1901013000127

1

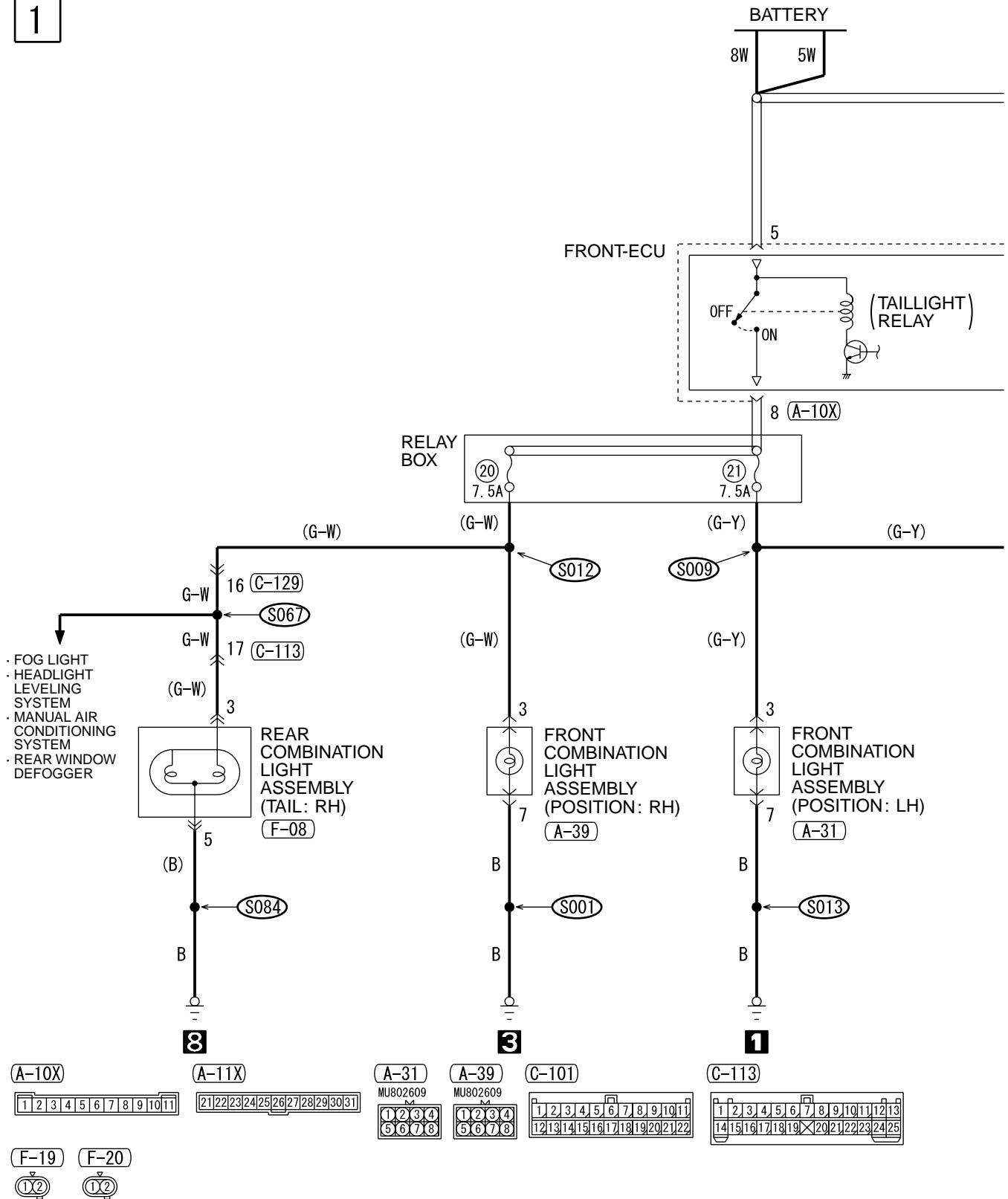

H3J08M06AA

TSB Revision

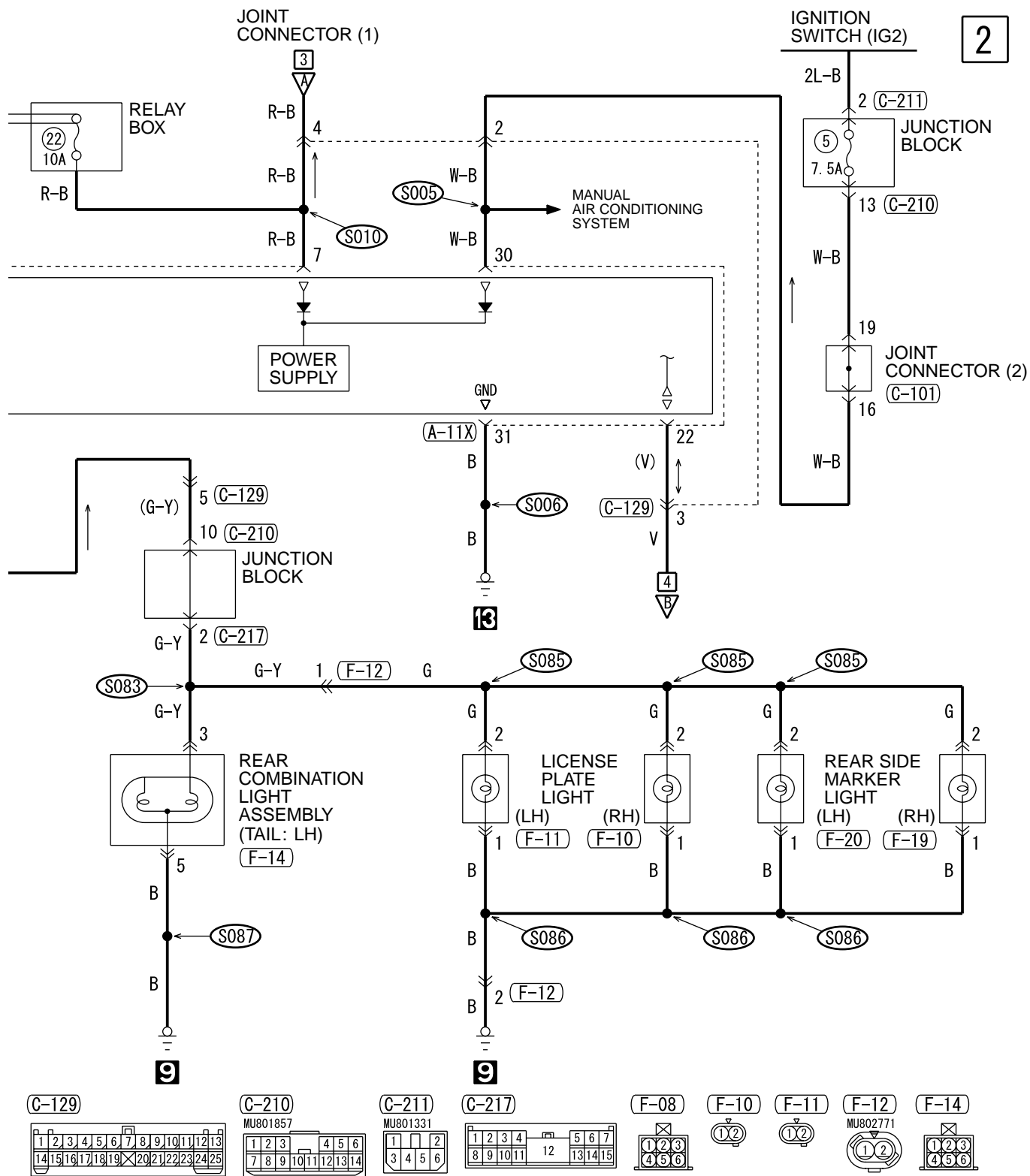

(C-129)

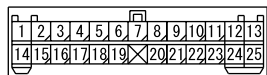

(C-210)

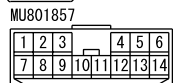

(C-211)



(C-217)

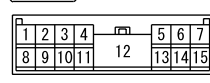

(F-08)



(F-10)



(F-11)



(F-12)



(F-14)



WIRE COLOR CODE

B: BLACK LG: LIGHT GREEN G: GREEN L: BLUE W: WHITE Y: YELLOW
 SB: SKY BLUE BR: BROWN O: ORANGE GR: GRAY R: RED P: PINK V: VIOLET

TAILLIGHT, POSITION LIGHT, SIDE MARKER LIGHT AND LICENSE PLATE LIGHT (CONTINUED)

3

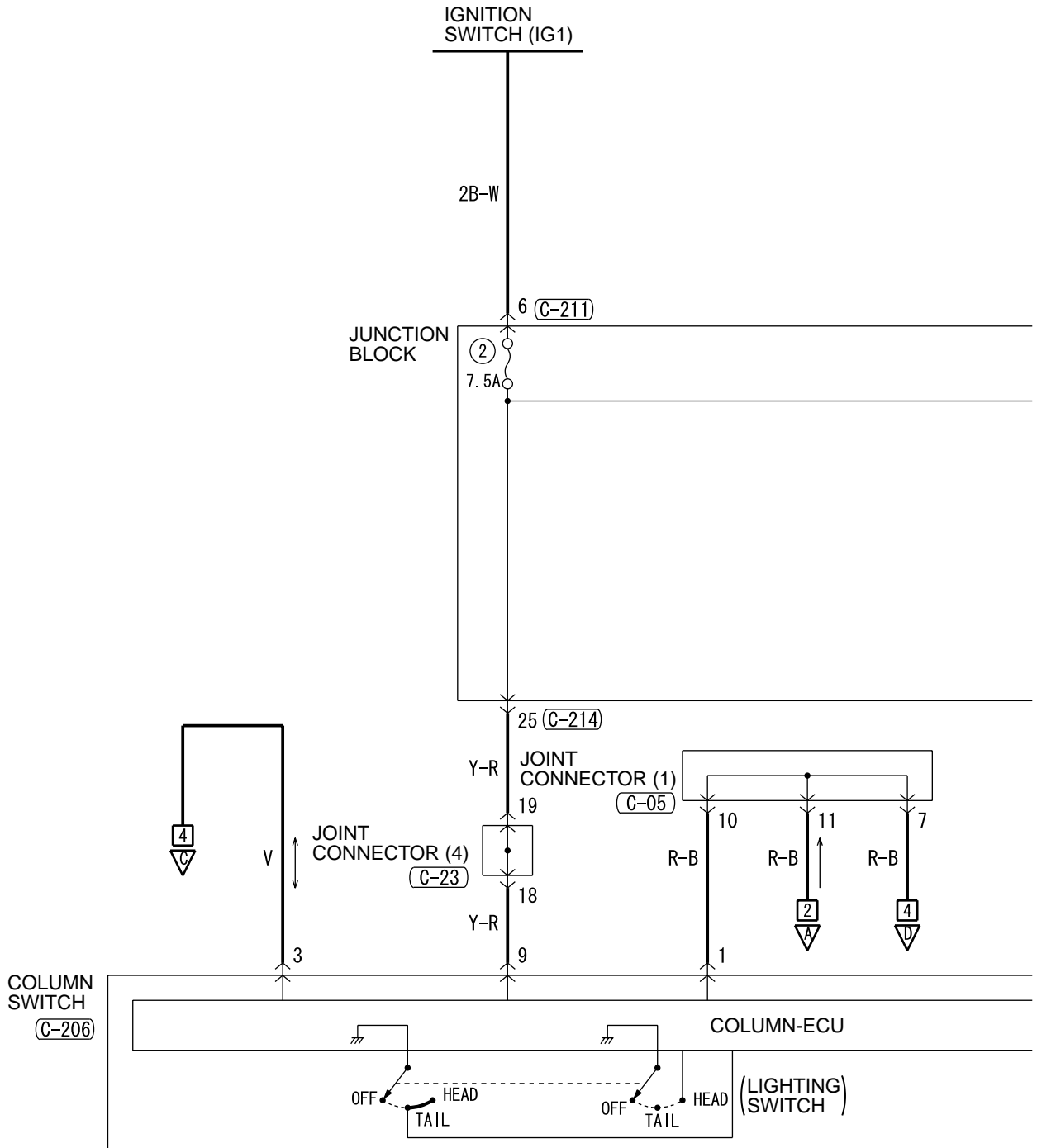

C-05

1	2	3	4	5	6	7	8	9	10	11
12	13	14	15	16	17	18	19	20	21	22

C-06

1	2	3	4	5	6	7	8	9	10	11
12	13	14	15	16	17	18	19	20	21	22

C-14 FRONT SIDE

1	2	3	4	5	6	7	8
9	10	11	12	13	14	15	16

C-23

1	2	3	4	5	6	7	8	9	10	11
12	13	14	15	16	17	18	19	20	21	22

C-101

1	2	3	4	5	6	7	8	9	10	11
12	13	14	15	16	17	18	19	20	21	22

C-126 (MU801380)

1	2	3
---	---	---

C-226 JUNCTION BLOCK SIDE

20	19	18	17	16	15	14	13	12	11	10	9	8	7	6	5	4	3	2	1
----	----	----	----	----	----	----	----	----	----	----	---	---	---	---	---	---	---	---	---

C-228 (MU803766)

51	52	53	54	55	56	57	58	59
60	61	62	63	64	65	66	67	68
69	70	71	72	73	74			

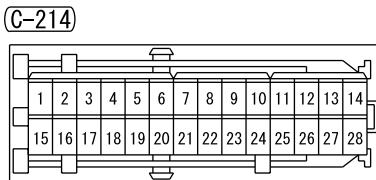
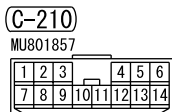
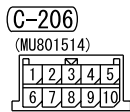
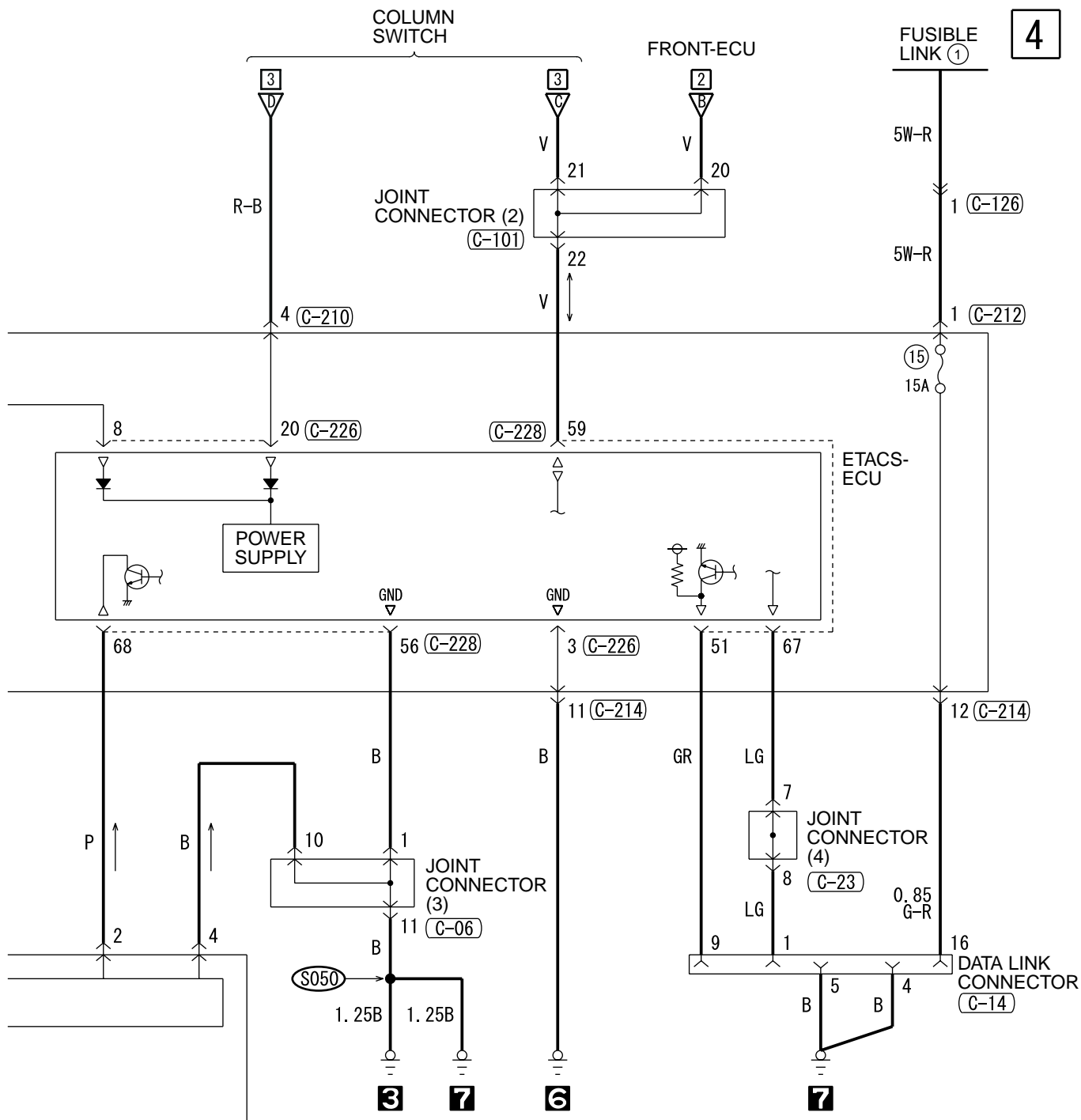

DOME LIGHT, LUGGAGE COMPARTMENT LIGHT AND IGNITION KEY CYLINDER ILLUMINATION LIGHT

M1901017300012

1

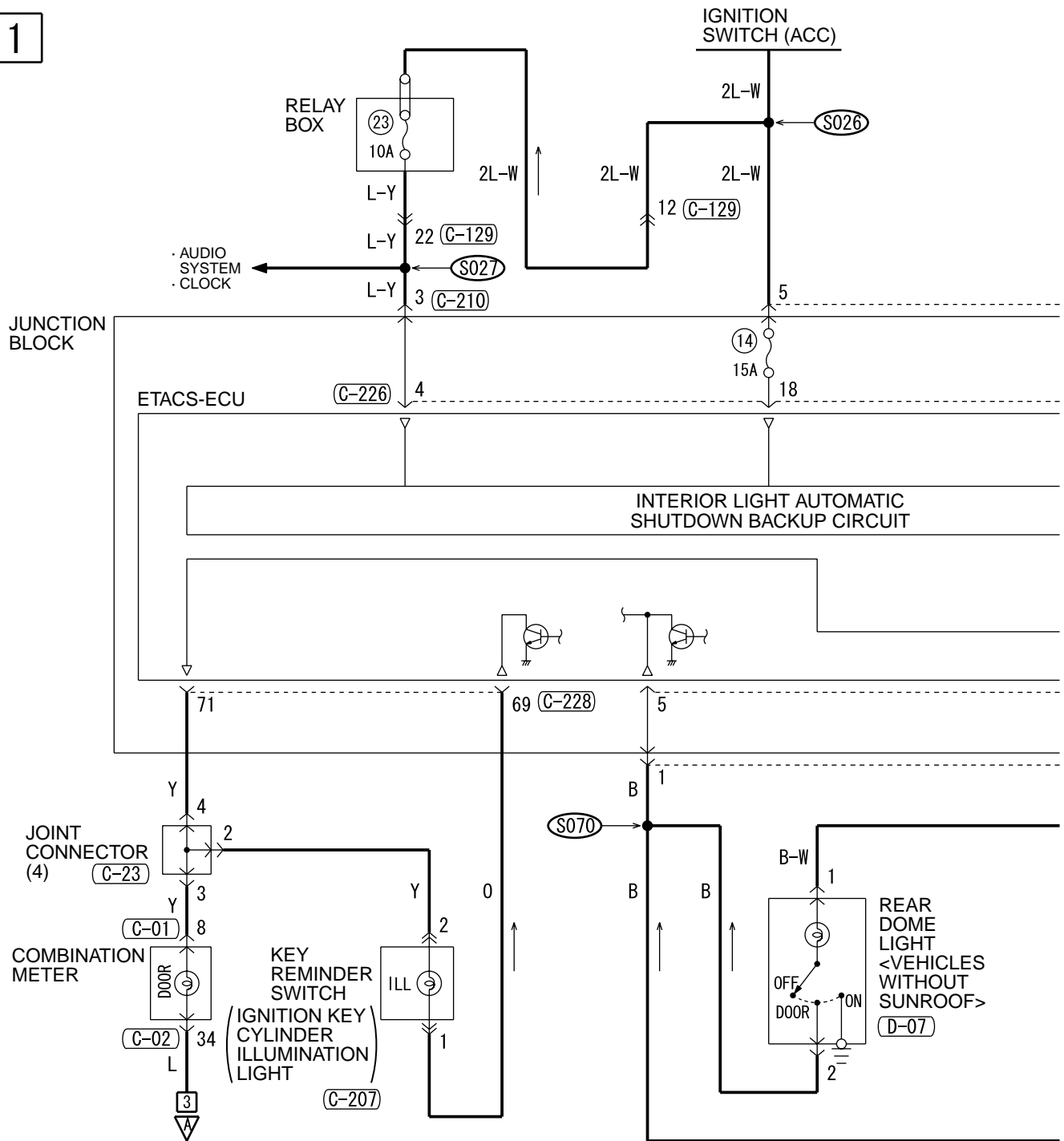

C-01

1	2	3	4	5	6	7	8	9	10	11	12	13	14	15	16	17	18	19	20	21	22
---	---	---	---	---	---	---	---	---	----	----	----	----	----	----	----	----	----	----	----	----	----

C-02

31	32	33	34	35	36	37	38	39	40	41	42	43	44	45	46	47	48	49	50	51
----	----	----	----	----	----	----	----	----	----	----	----	----	----	----	----	----	----	----	----	----

C-05

1	2	3	4	5	6	7	8	9	10	11
12	13	14	15	16	17	18	19	20	21	22

C-226

JUNCTION BLOCK SIDE

20	19	18	17	16	15	14	13	12	11	10	9	8	7	6	5	4	3	2	1
----	----	----	----	----	----	----	----	----	----	----	---	---	---	---	---	---	---	---	---

C-228

(MU803766)

51	52	53	54	55	56	57	58	59
60	61	62	63	64	65	66	67	68
69	70	71	72	73	74			

D-05

1	2
---	---

D-07

1	2
---	---

F-02

1	2
---	---

F-09

(MU801211)

1	2
---	---

2

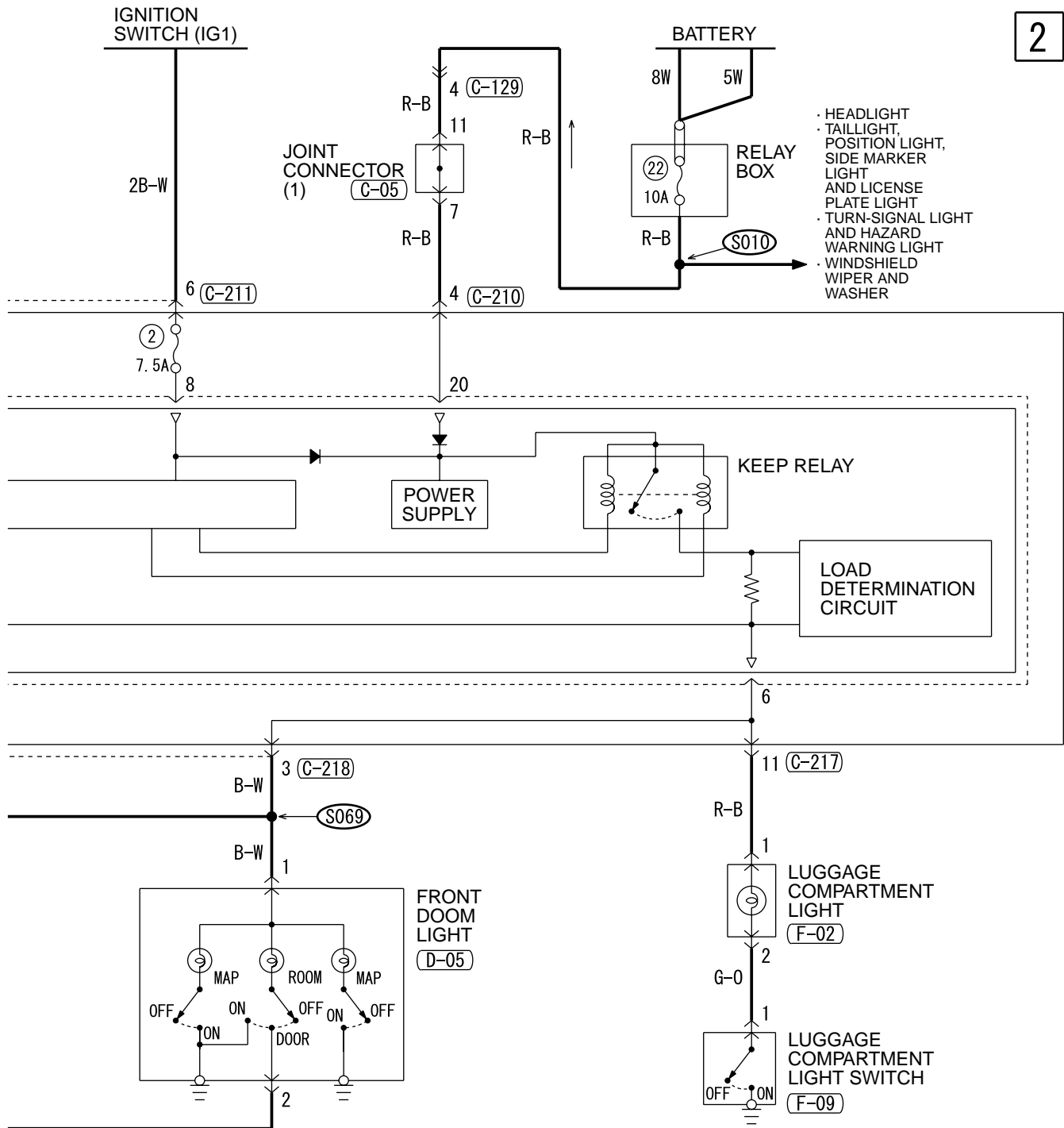

- HEADLIGHT
- TAILLIGHT, POSITION LIGHT, SIDE MARKER LIGHT AND LICENSE PLATE LIGHT
- TURN-SIGNAL LIGHT AND HAZARD WARNING LIGHT
- WINDSHIELD WIPER AND WASHER

C-23

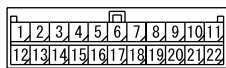

C-129

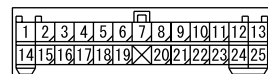

C-207

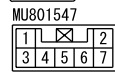

C-210

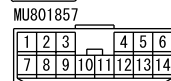

C-211



C-217

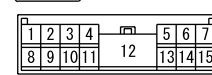

C-218



WIRE COLOR CODE

B : BLACK : LIGHT GREEN G : GREEN L : BLUE W : WHITE Y : YELLOW
 SB : SKY BLUE BR : BROWN O : ORANGE GR : GRAY R : RED P : PINK V : VIOLET

DOME LIGHT, LUGGAGE COMPARTMENT LIGHT AND IGNITION KEY CYLINDER ILLUMINATION LIGHT (CONTINUED)

3

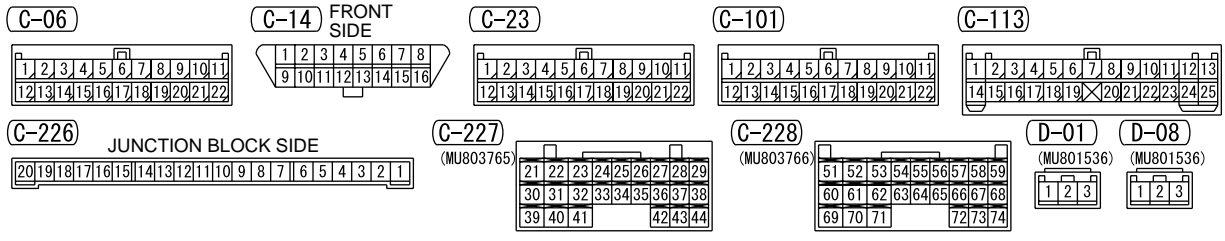
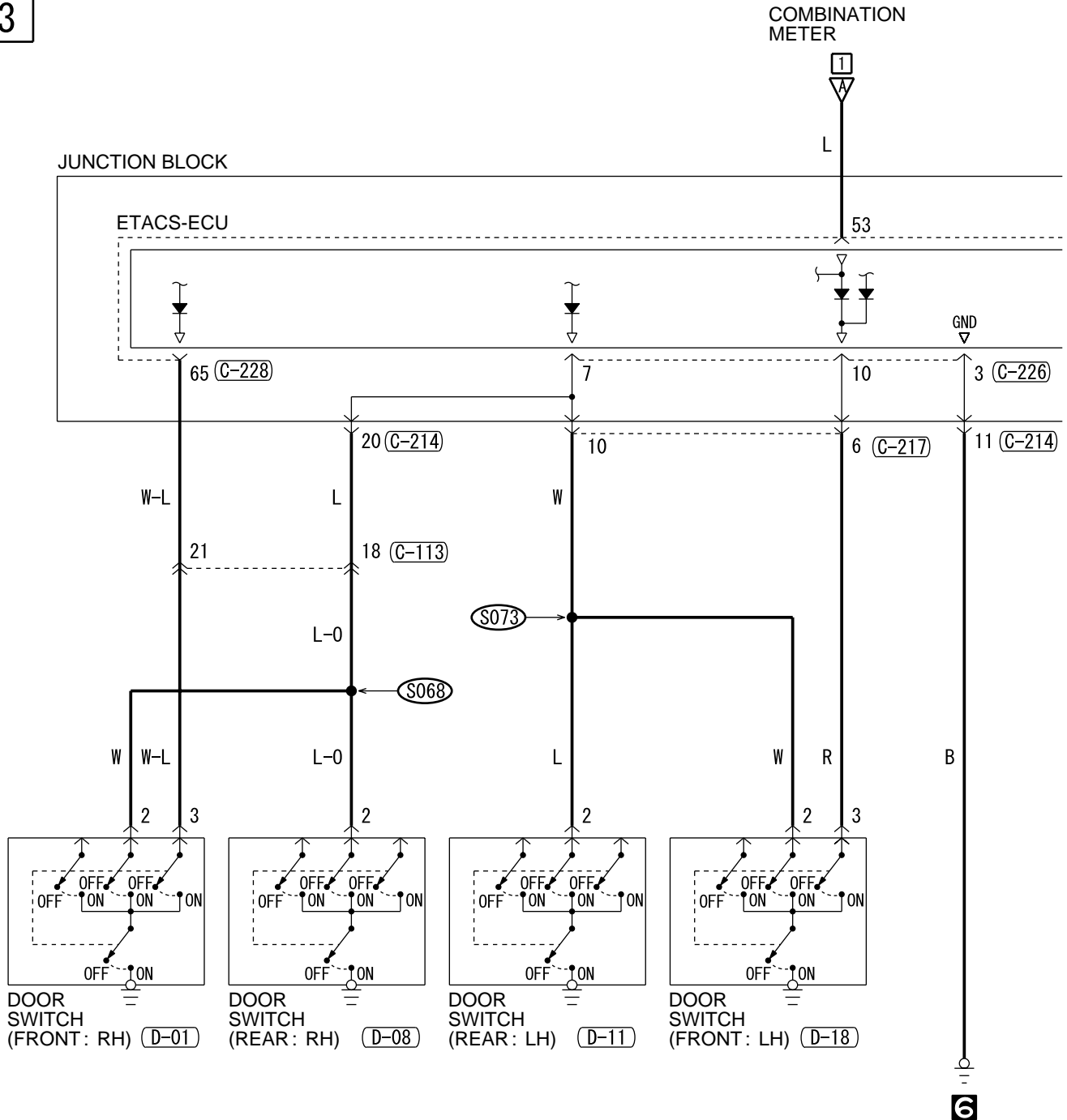

4

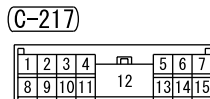
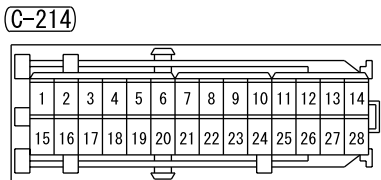
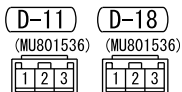
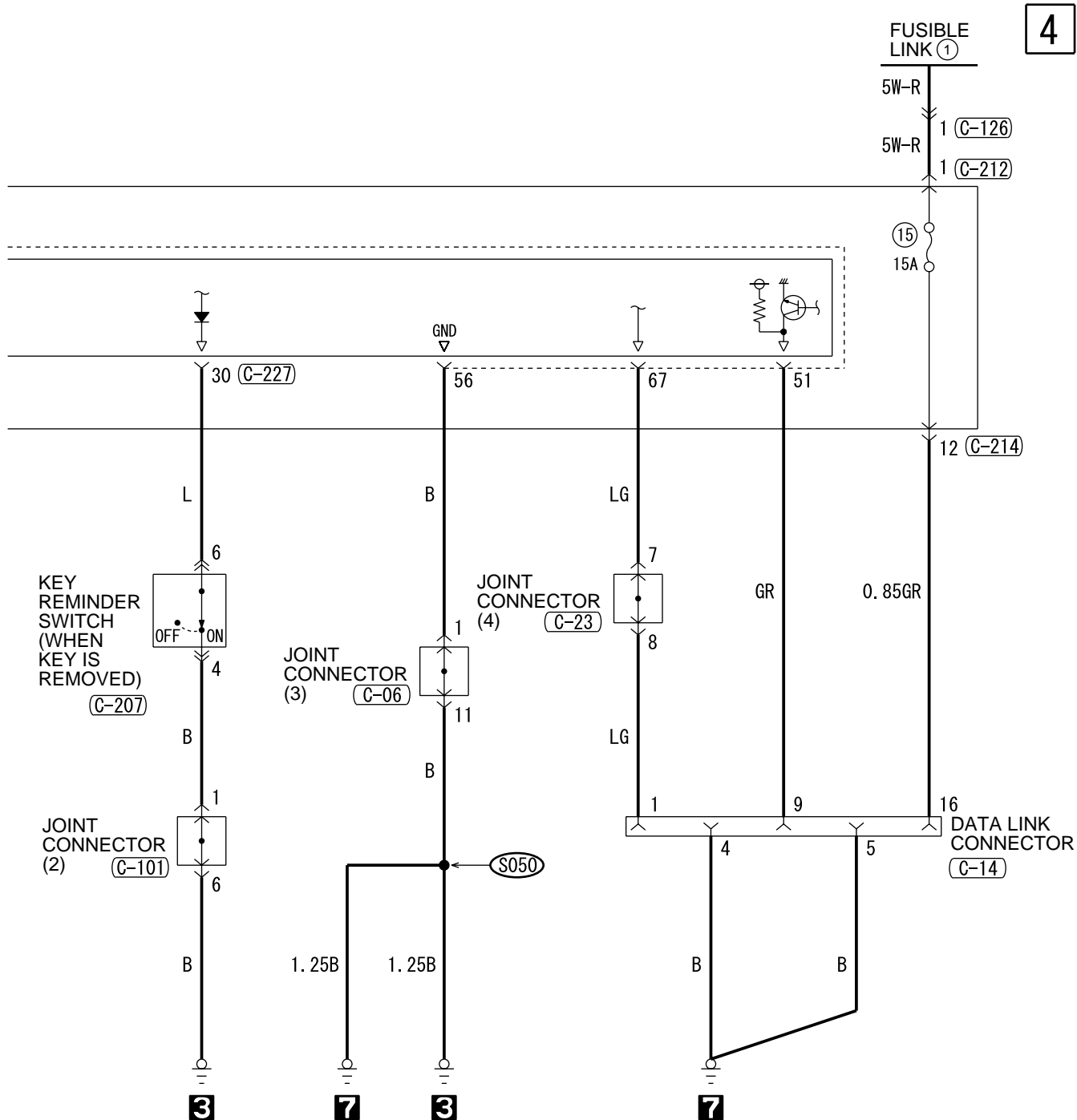

FOG LIGHT

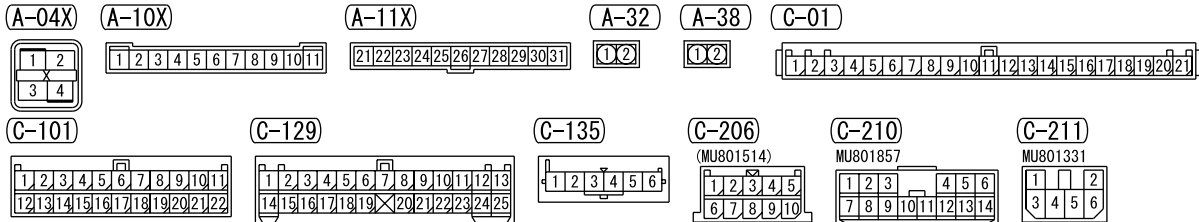
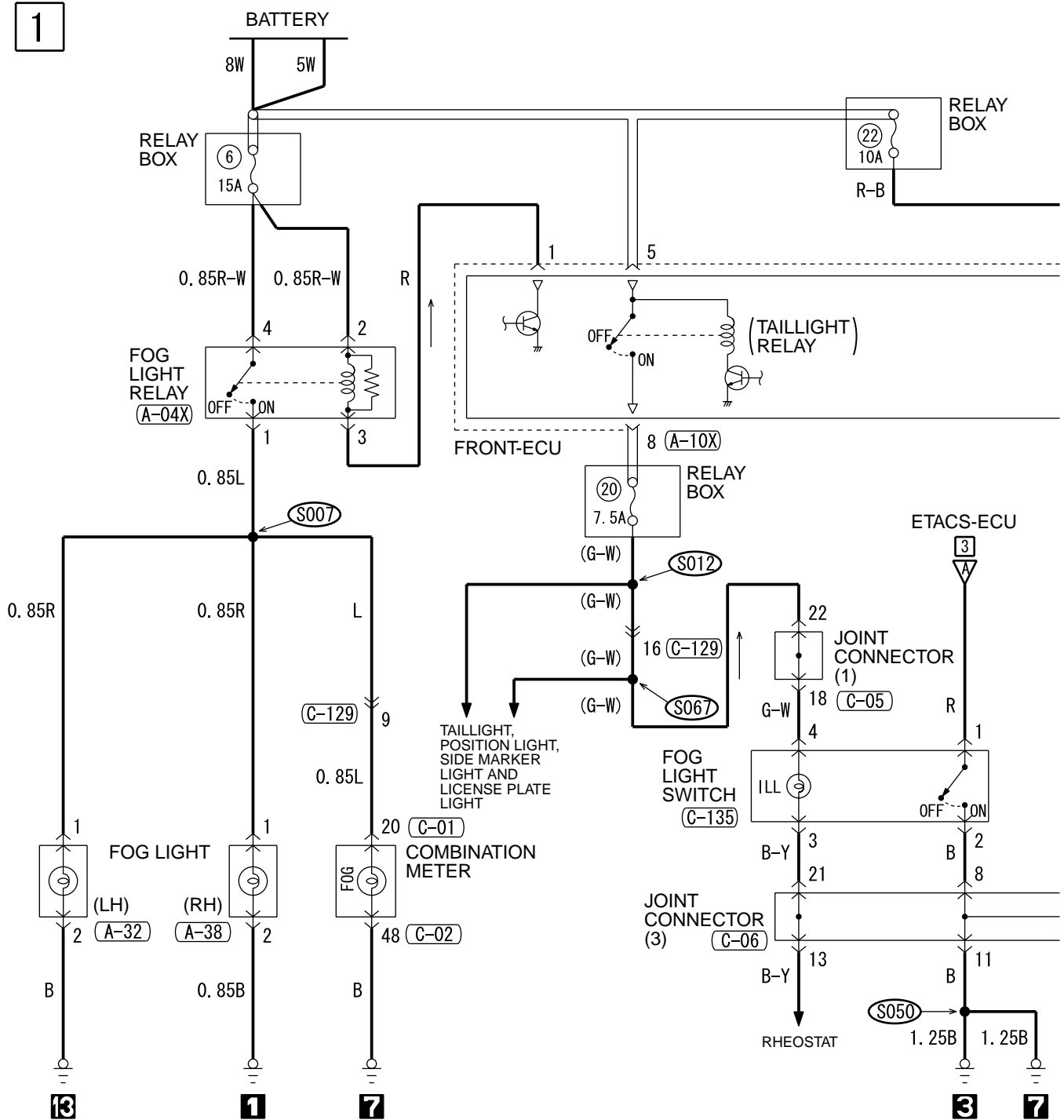

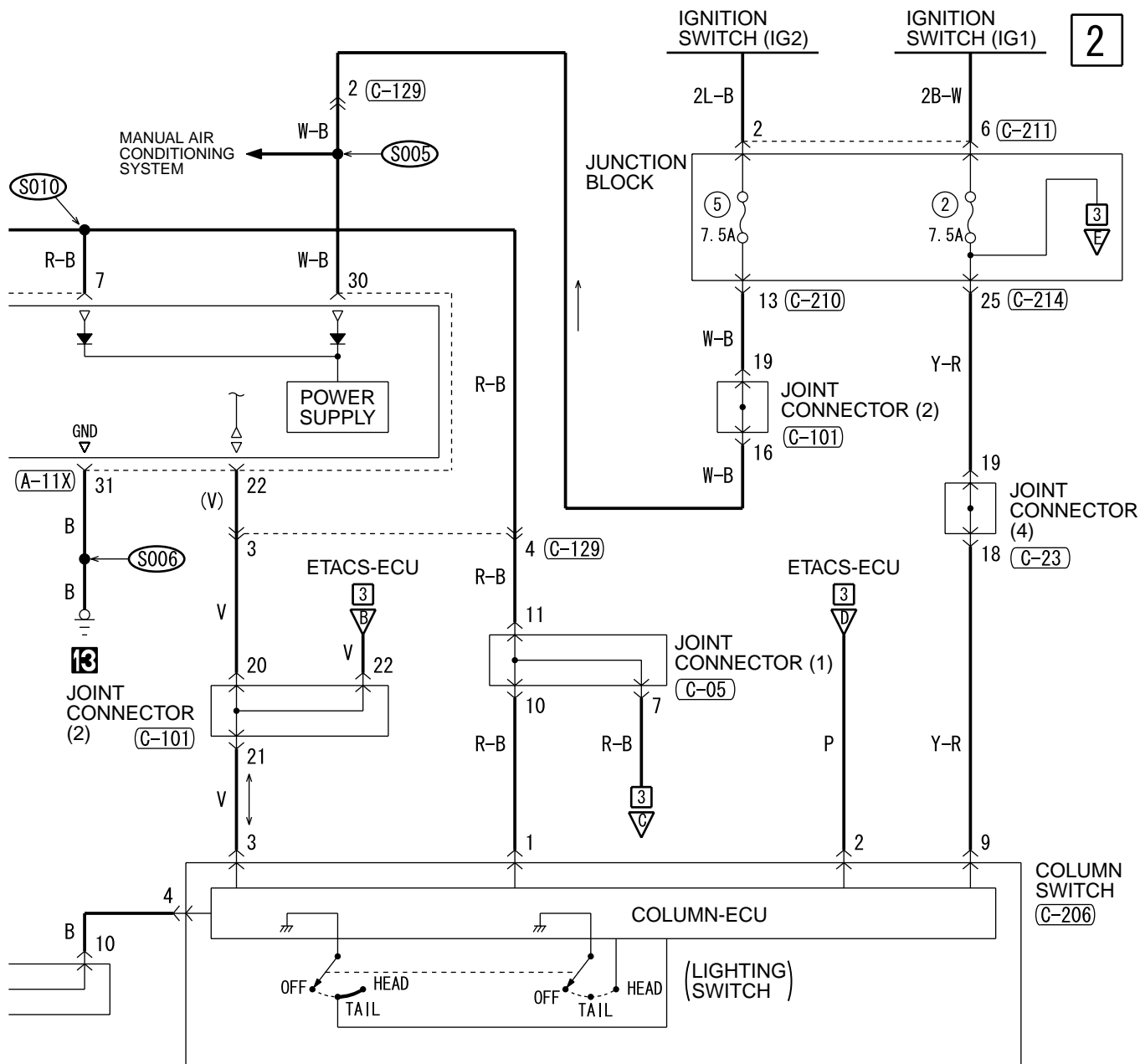

(C-02)

1	2	3	34	35	36	37	38	39	40	41	42	43	44	45	46	47	48	49	50	51
---	---	---	----	----	----	----	----	----	----	----	----	----	----	----	----	----	----	----	----	----

(C-05)

1	2	3	4	5	6	7	8	9	10	11
12	13	14	15	16	17	18	19	20	21	22

(C-06)

1	2	3	4	5	6	7	8	9	10	11
12	13	14	15	16	17	18	19	20	21	22

(C-23)

1	2	3	4	5	6	7	8	9	10	11
12	13	14	15	16	17	18	19	20	21	22

(C-214)

1	2	3	4	5	6	7	8	9	10	11	12	13	14
15	16	17	18	19	20	21	22	23	24	25	26	27	28

WIRE COLOR CODE

B : BLACK LG : LIGHT GREEN G : GREEN L : BLUE
BR : BROWN O : ORANGE GR : GRAY R : RED W : WHITE
SB : SKY BLUE P : PINK Y : YELLOW V : VIOLET

H3J08M07AB

FOG LIGHT (CONTINUED)

3

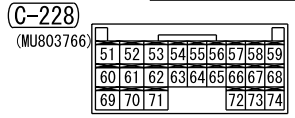
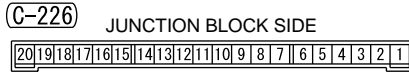
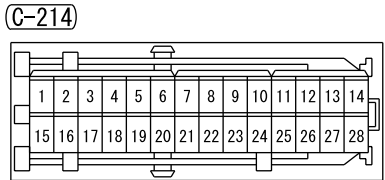
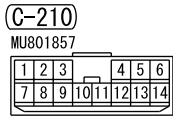
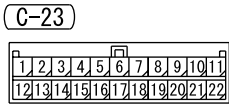
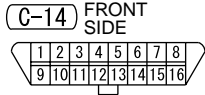
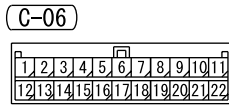
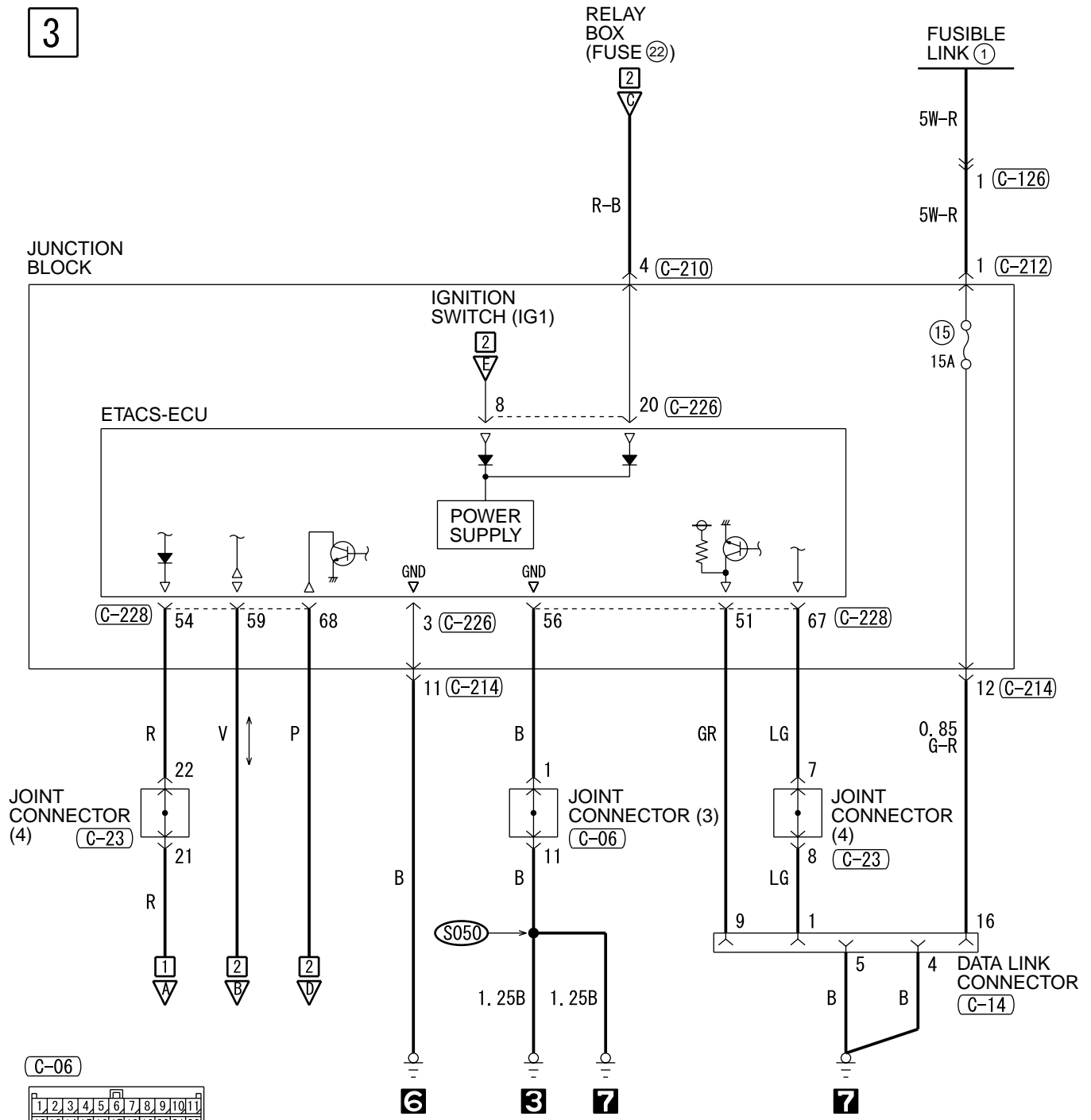

HORN

M1901003300503

1

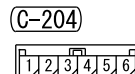
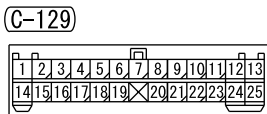
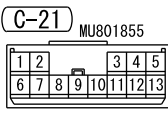
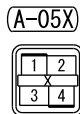
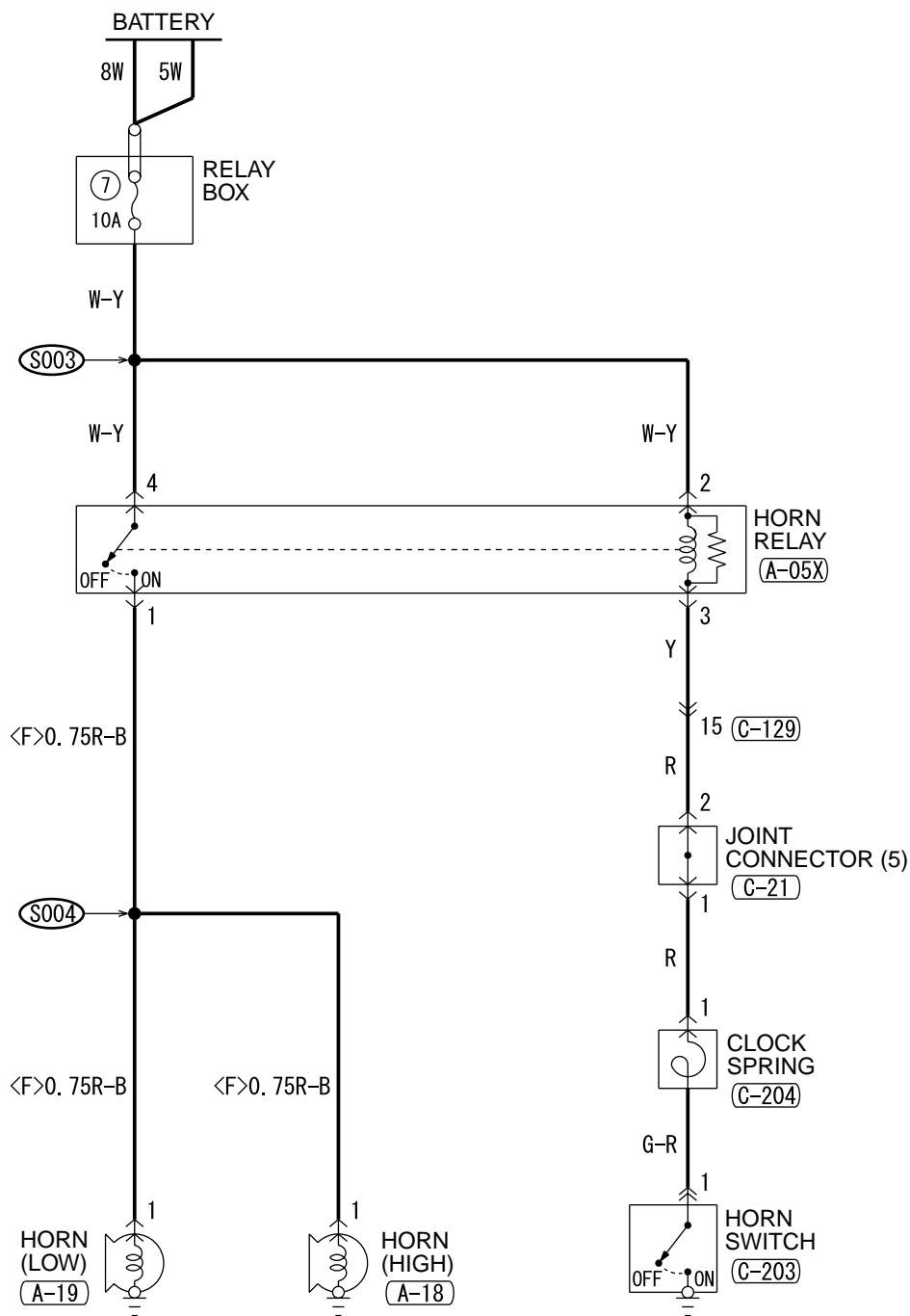

STOPLIGHT

M1901003000580

1

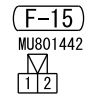
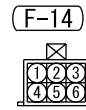
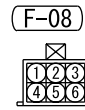
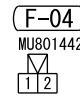
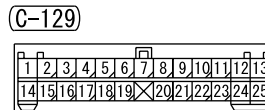
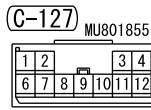
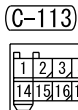
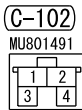
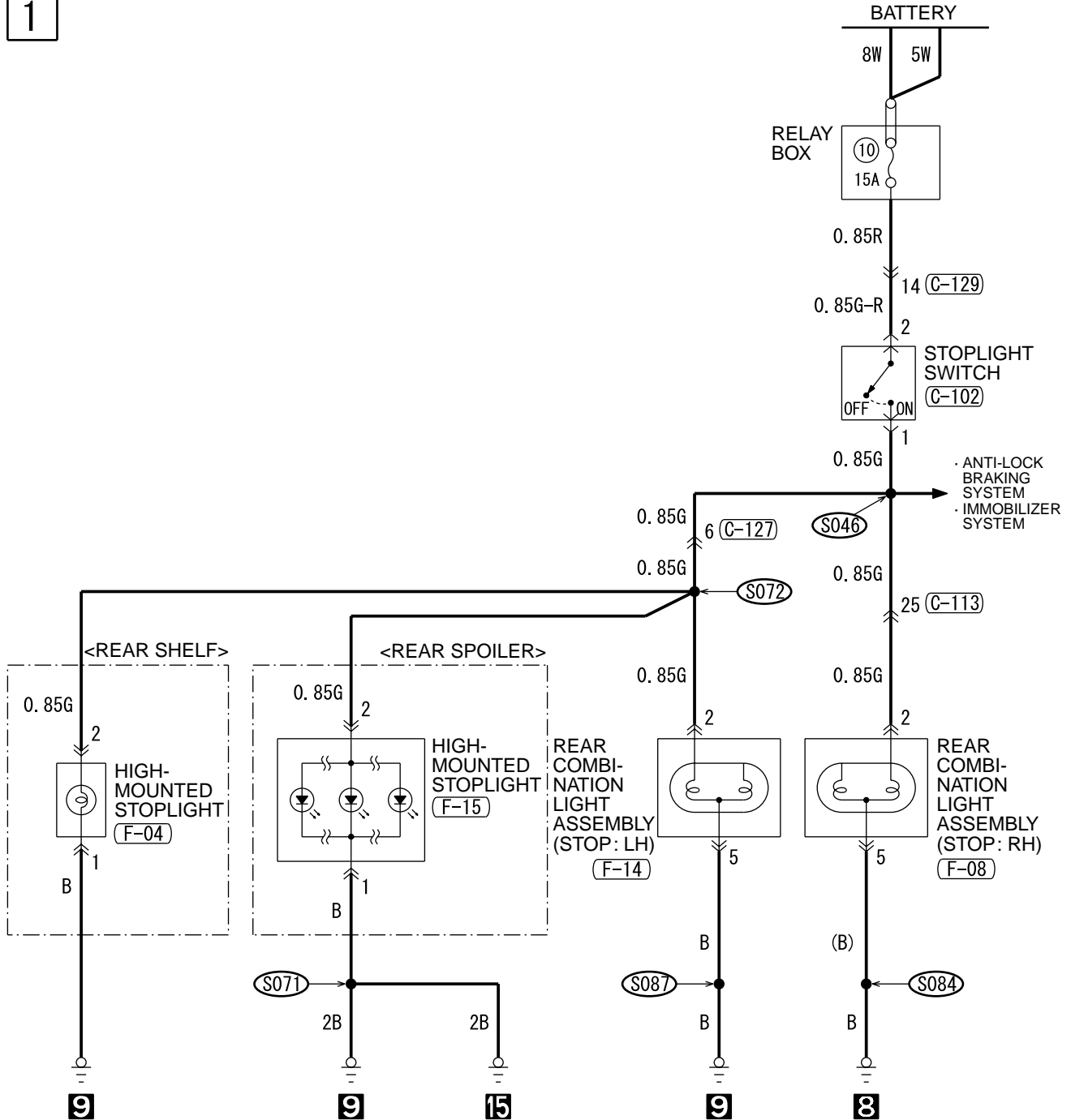

WIRE COLOR CODE

B : BLACK LG : LIGHT GREEN G : GREEN L : BLUE W : WHITE Y : YELLOW
 SB : SKY BLUE BR : BROWN O : ORANGE GR : GRAY R : RED P : PINK V : VIOLET

H3J09M05AA

TSB Revision

BACKUP LIGHT

M1901003100640

1

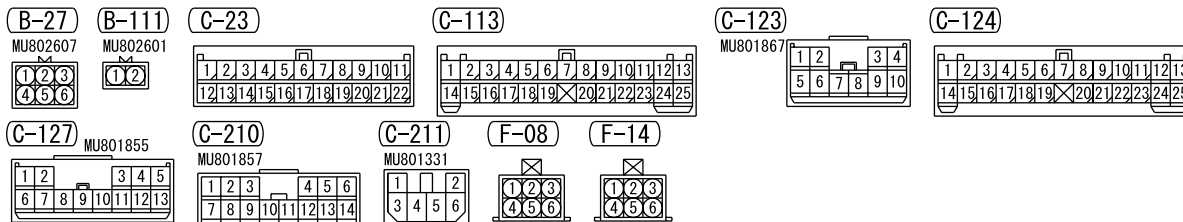
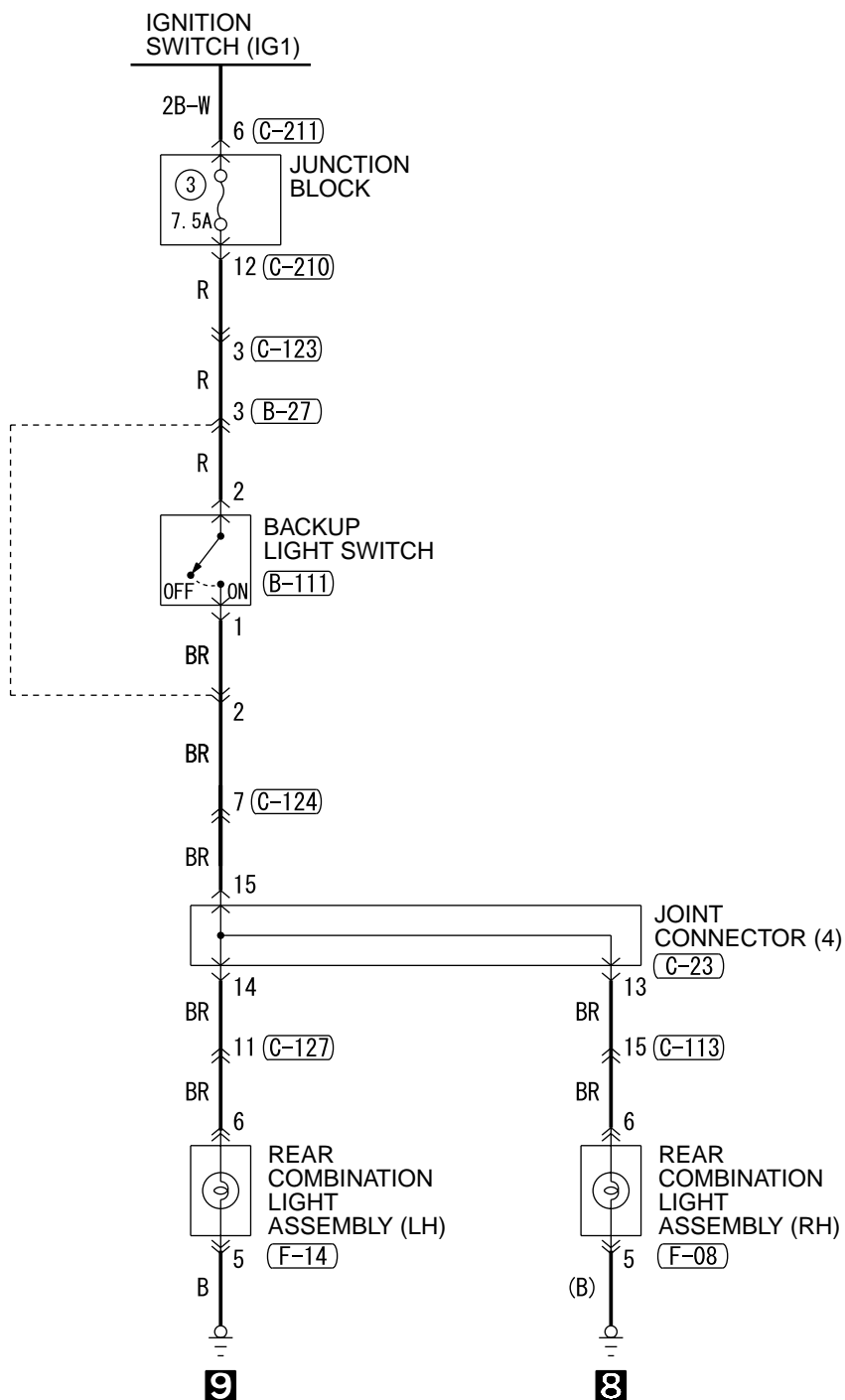

H3J09M06AA

TSB Revision

TURN SIGNAL LIGHT AND HAZARD WARNING LIGHT

M1901002900654

1

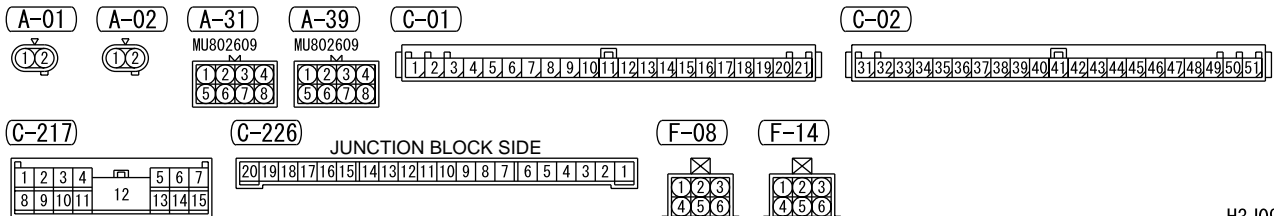
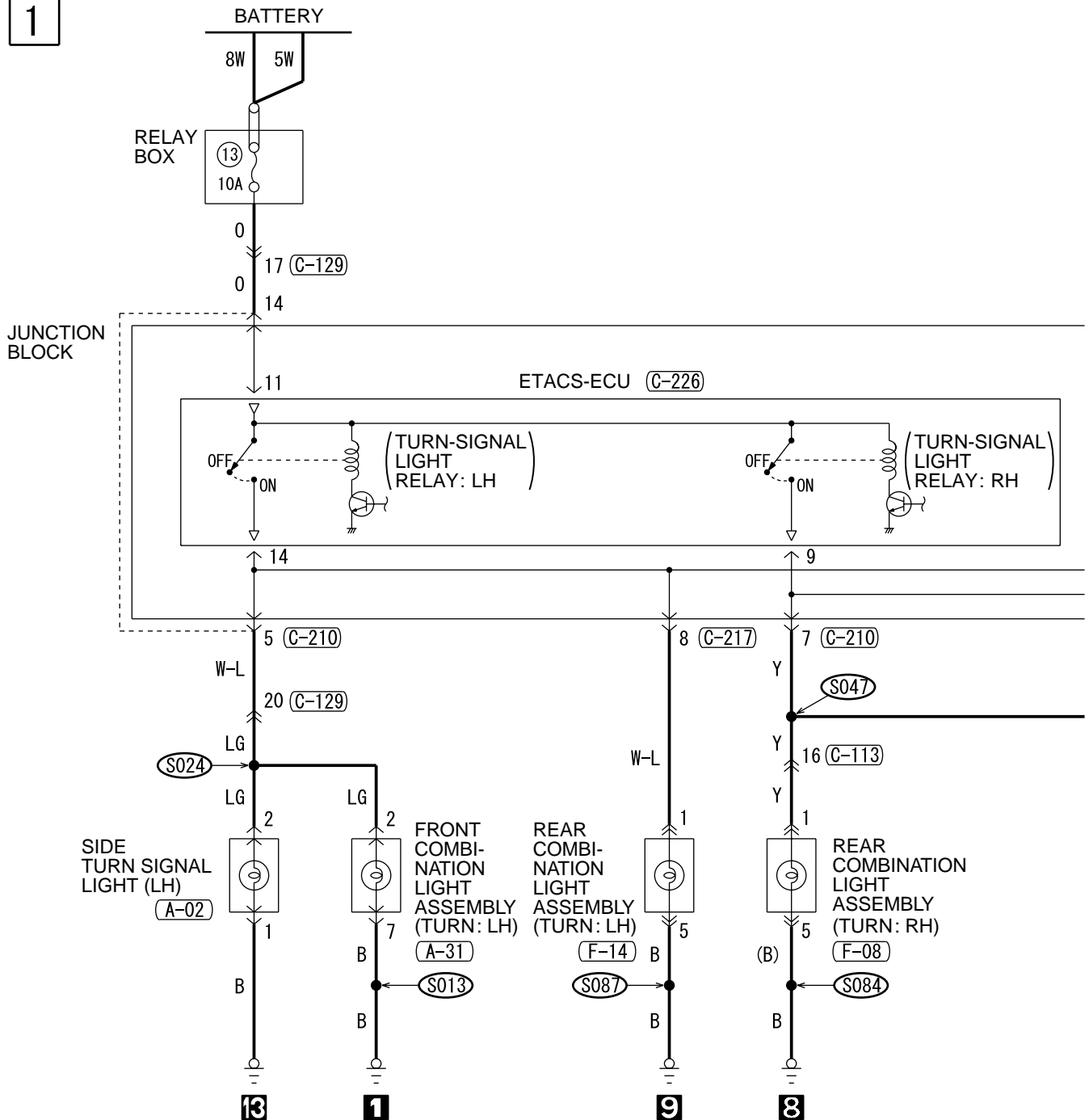

H3J09M04AA

2

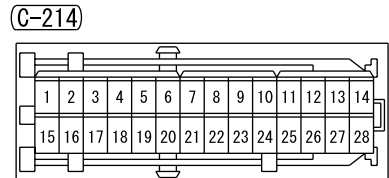
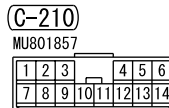
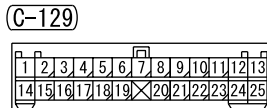
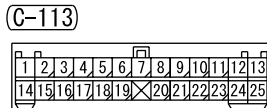
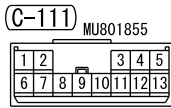
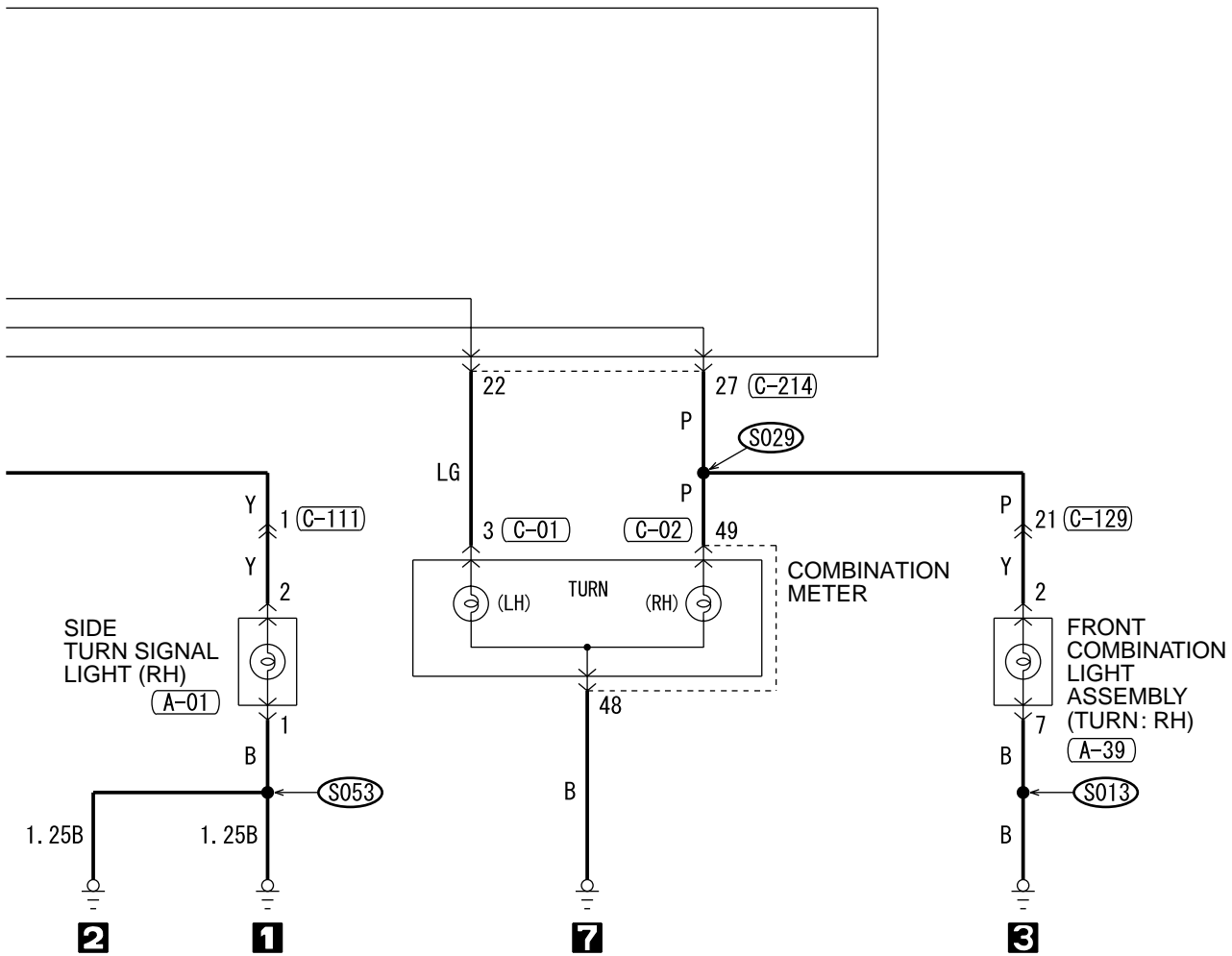

WIRE COLOR CODE
 B : BLACK LG : LIGHT GREEN G : GREEN L : BLUE
 BR : BROWN O : ORANGE GR : GRAY R : RED W : WHITE
 SB : SKY BLUE P : PINK Y : YELLOW V : VIOLET

H3J09M04AB

TURN SIGNAL LIGHT AND HAZARD WARNING LIGHT (CONTINUED)

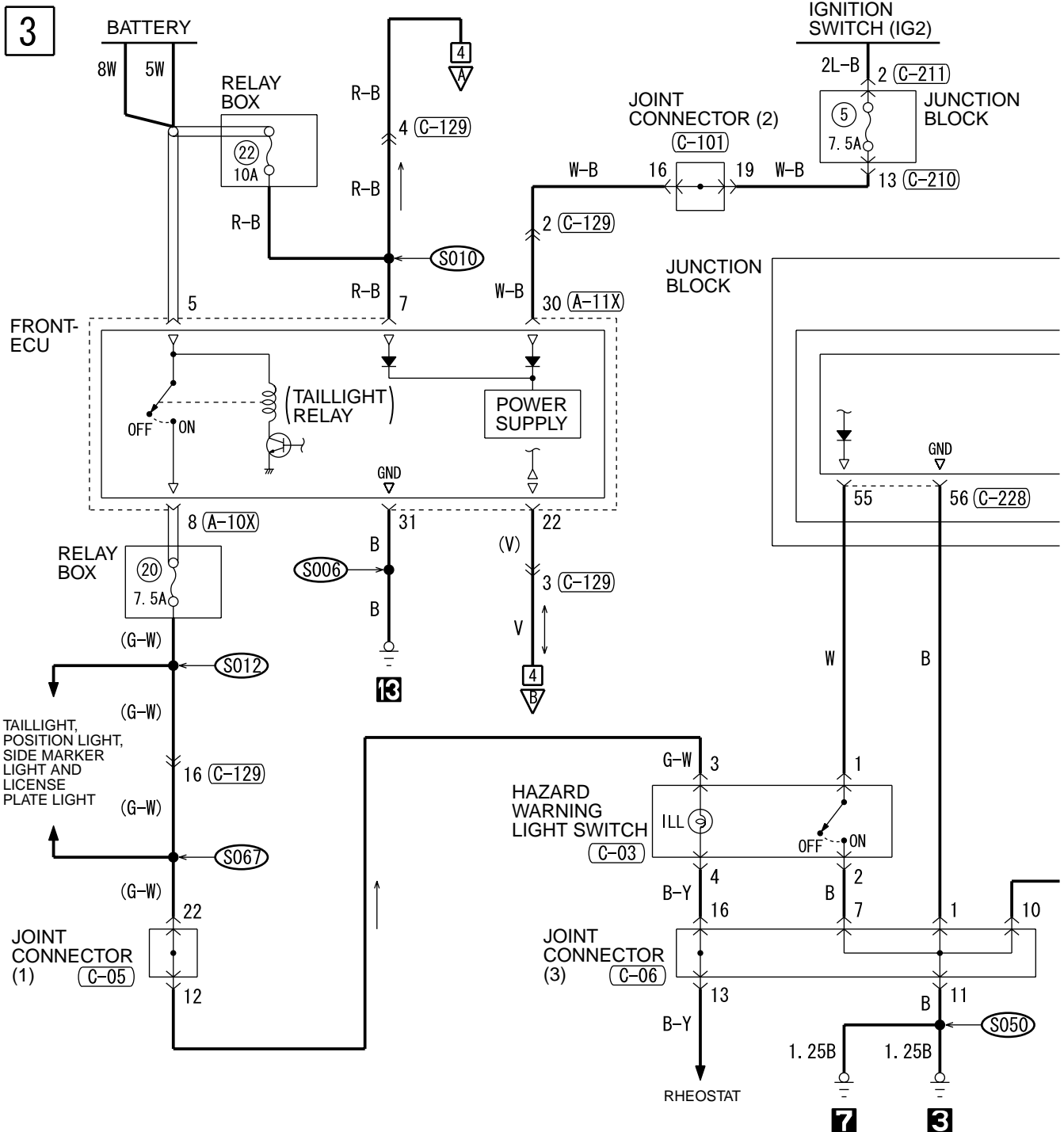

(A-10X)



(A-11X)

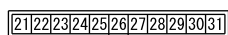

(C-03)



(C-05)

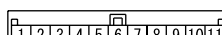

(C-06)

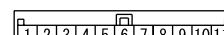

(C-14) FRONT SIDE

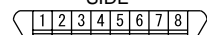

(C-206)

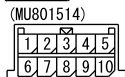

(C-210)

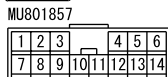

(C-211)



(C-212)



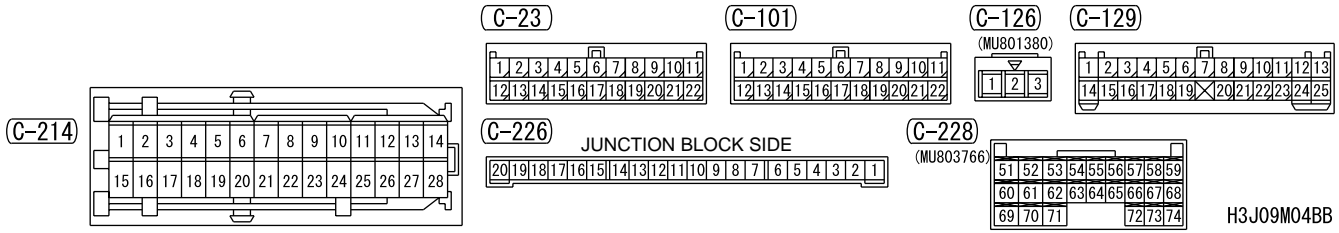
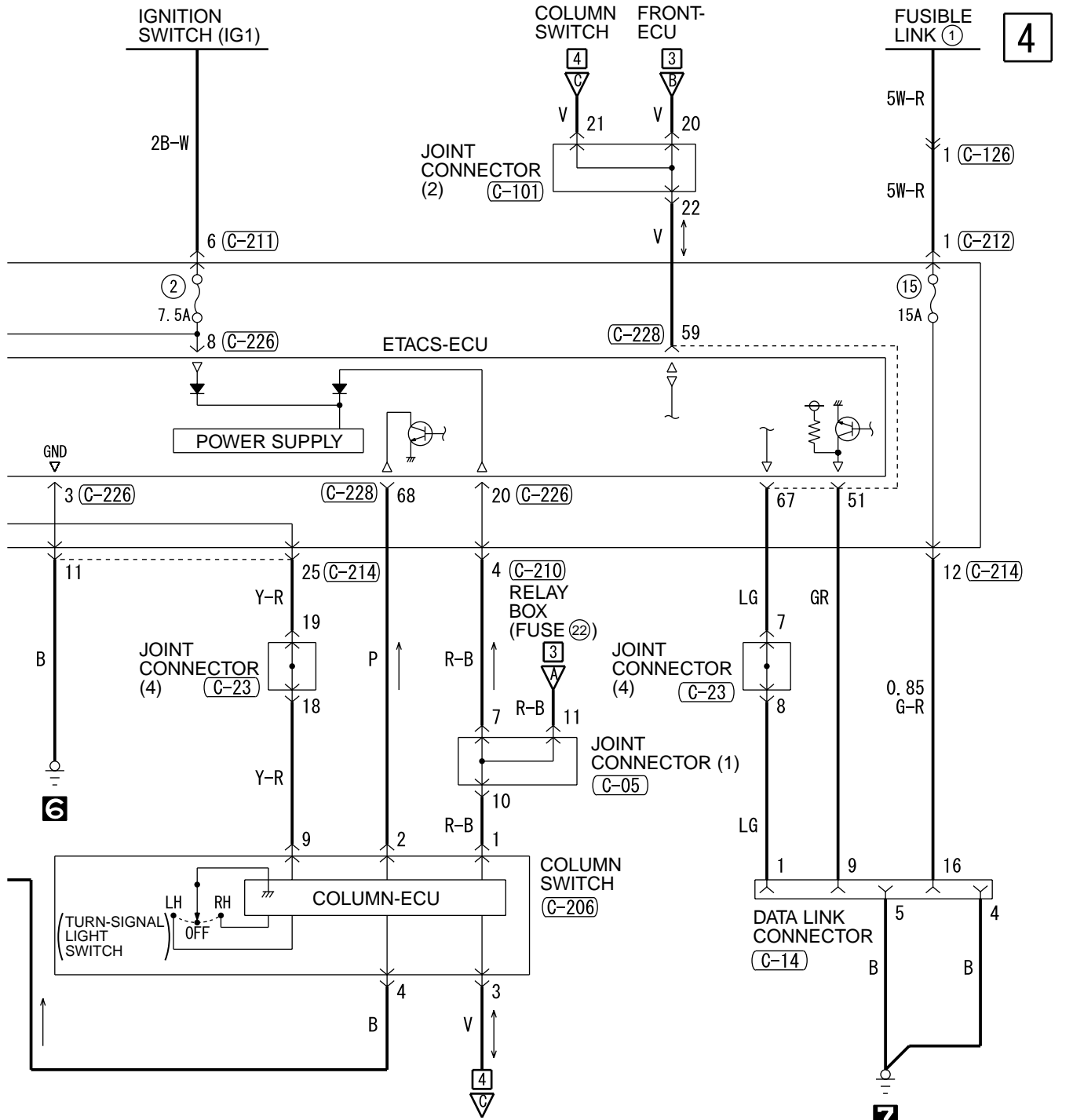

METER AND GAUGE

M1901003500529

1

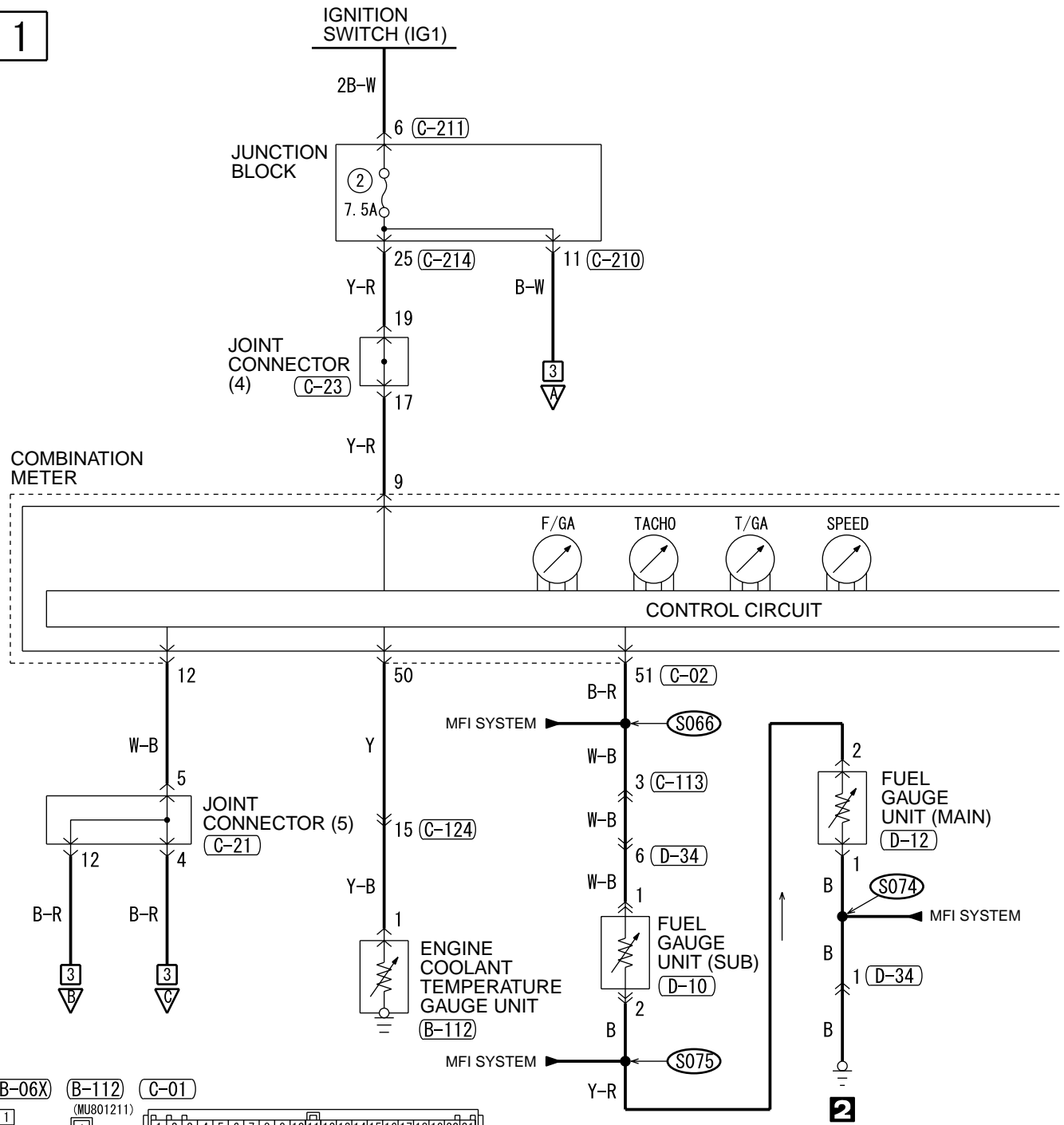

(B-06X) (B-112) (C-01)

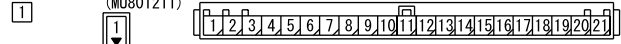

(C-02)

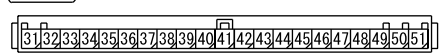

(C-05)

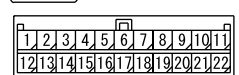

(C-06)

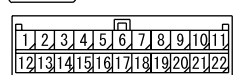

(C-21)

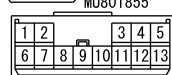

(C-123)

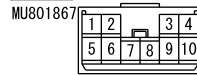

(C-124)

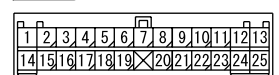

(C-129)

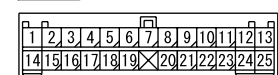

(C-210)

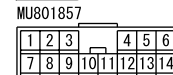

(C-211)



H3J10M03AA

TSB Revision

2

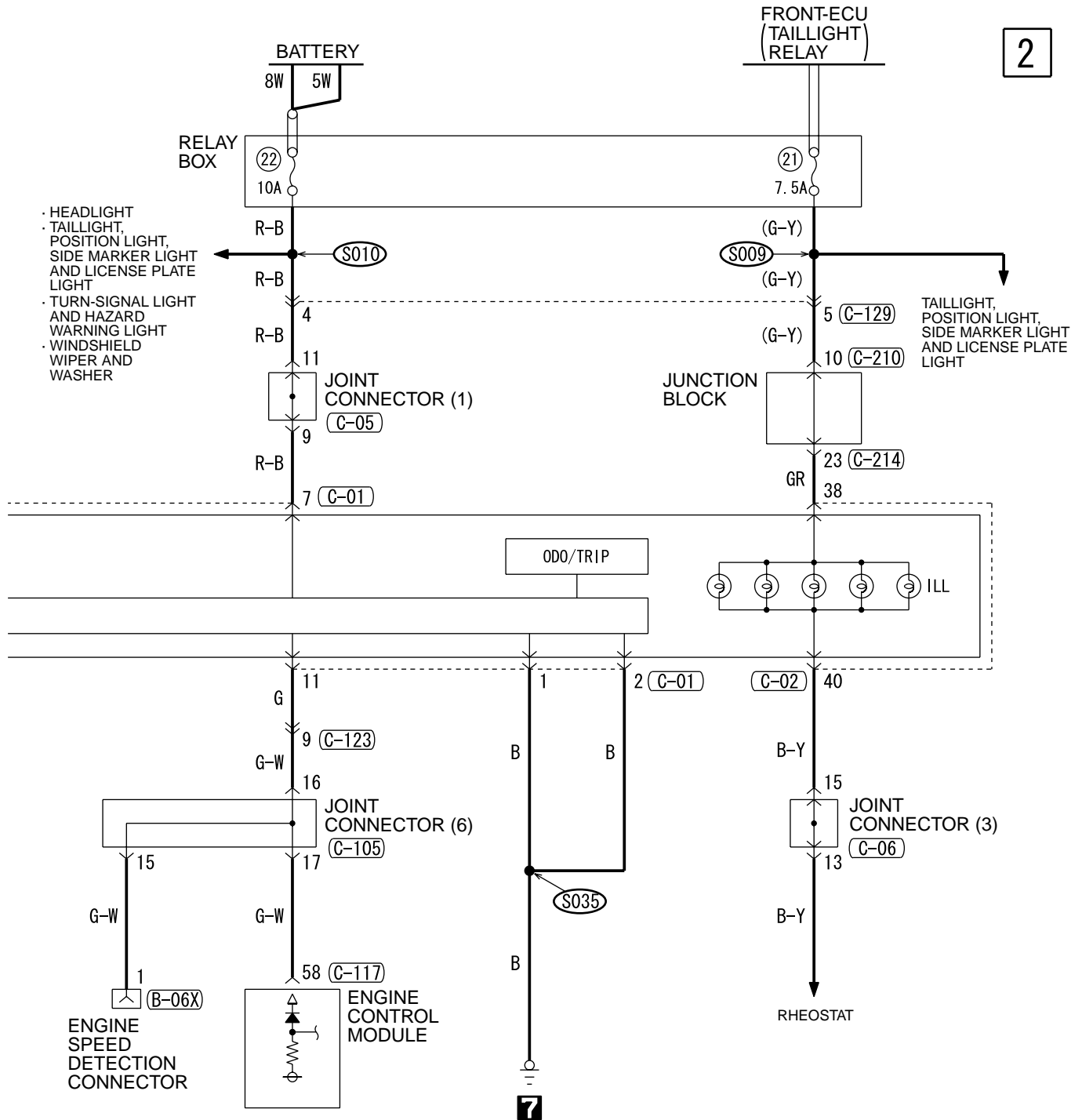

C-23

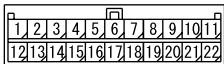

C-214

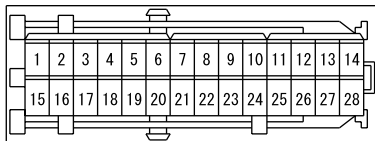

C-105

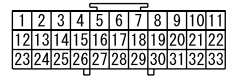

D-10



D-12



D-34



C-117

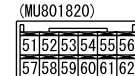

C-113

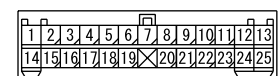

METER AND GAUGE (CONTINUED)

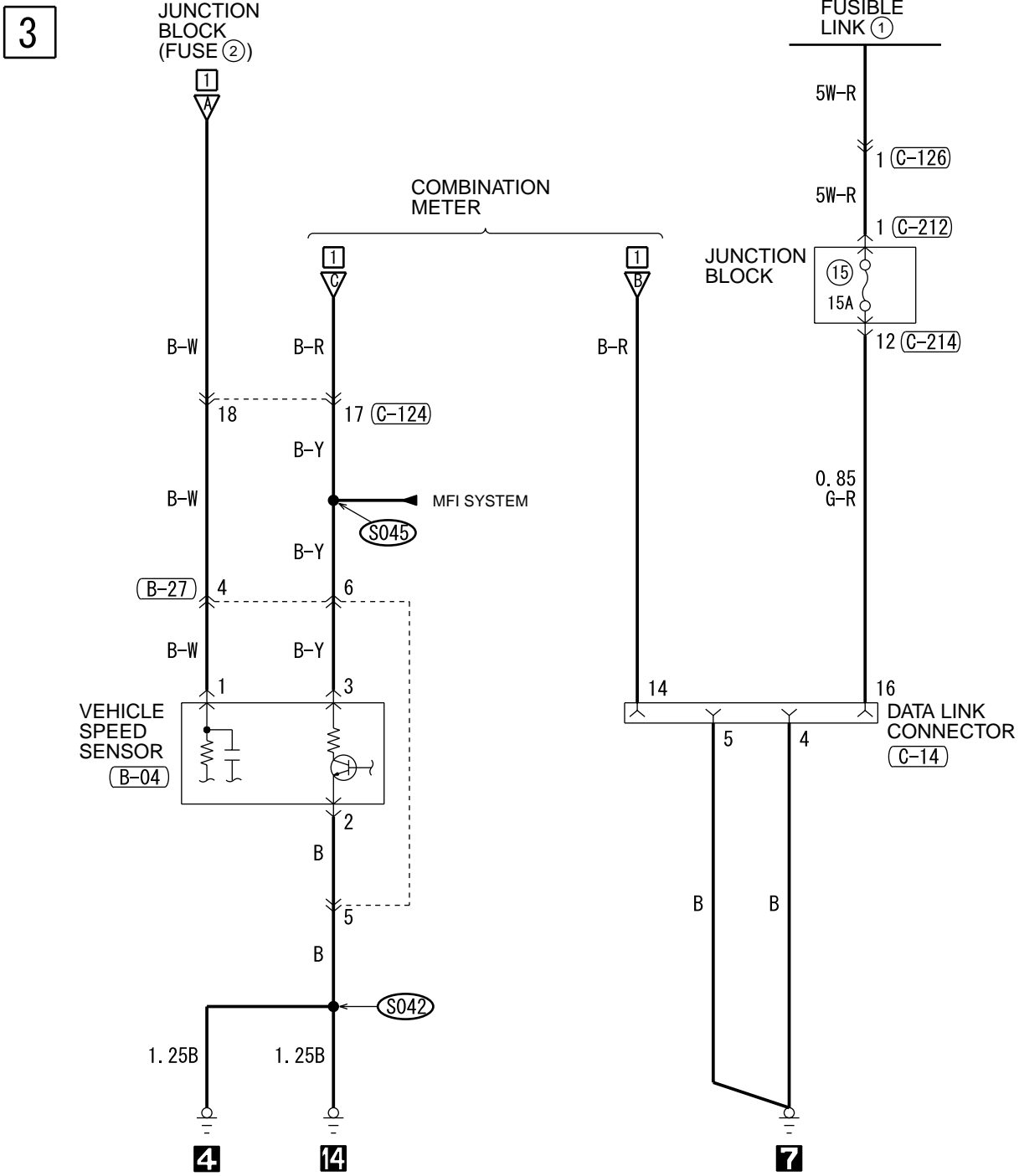

(B-04) (MU802723) **(B-27)** MU802607 **(C-14) FRONT SIDE** **(C-124)** **(C-126)** (MU801380) **(C-212)** MU801403 **(C-214)**

WIRE COLOR CODE
 B : BLACK LG : LIGHT GREEN G : GREEN L : BLUE
 BR : BROWN O : ORANGE GR : GRAY R : RED W : WHITE
 SB : SKY BLUE P : PINK Y : YELLOW V : VIOLET

NOTES

BRAKE WARNING LIGHT, OIL WARNING LIGHT, FUEL WARNING LIGHT

M1901018600049

1

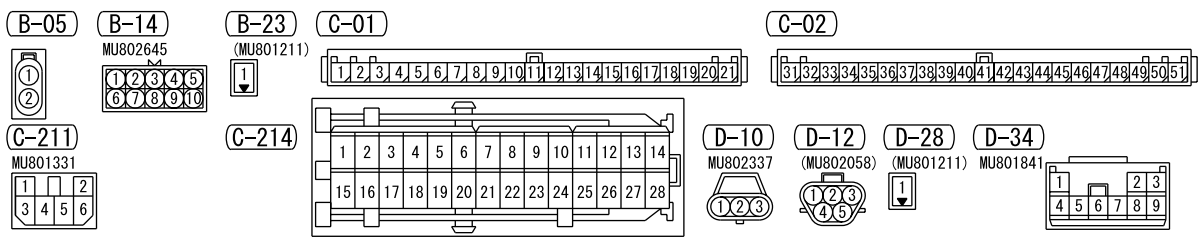
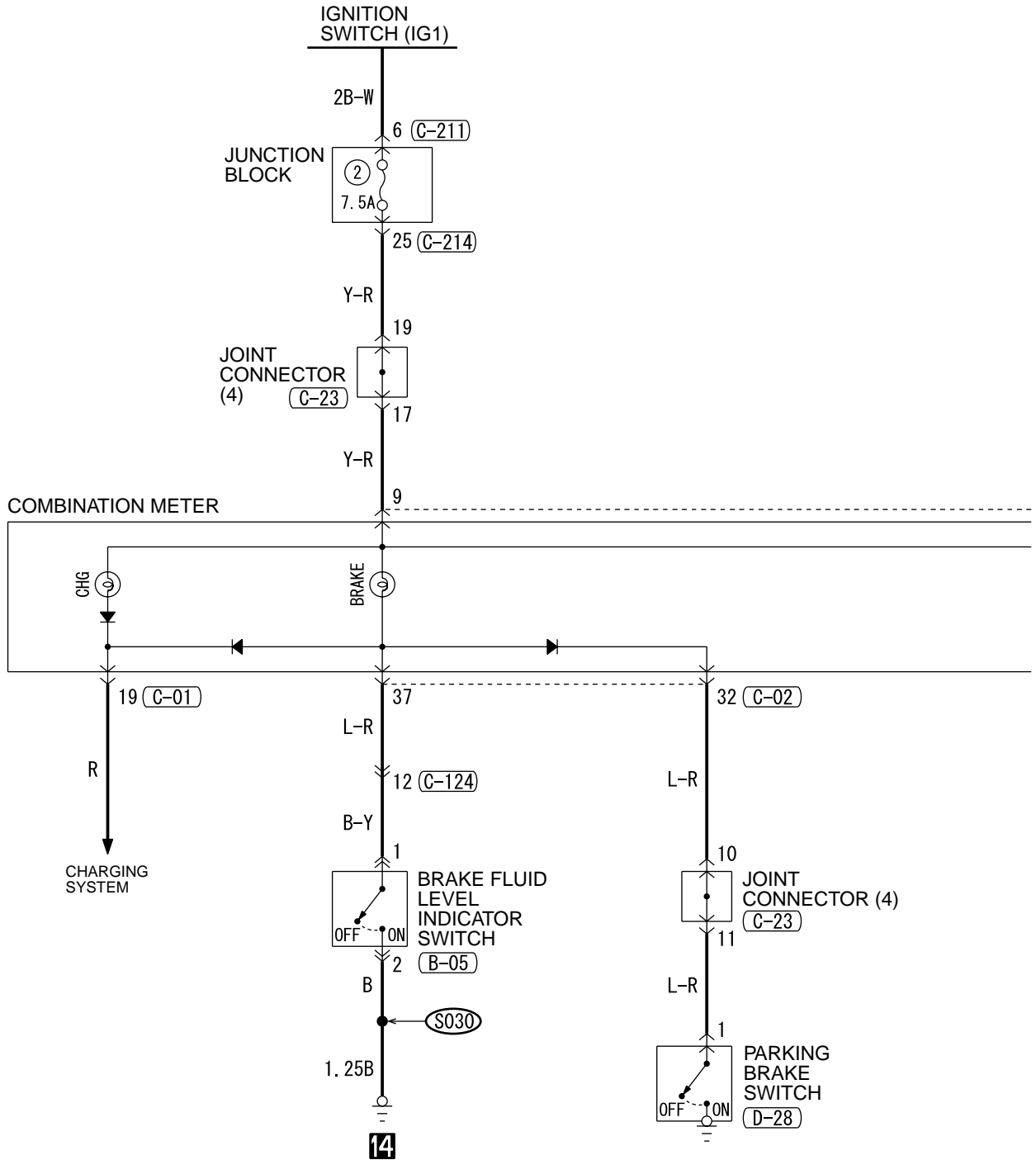

H3J10M04AA

TSB Revision

2

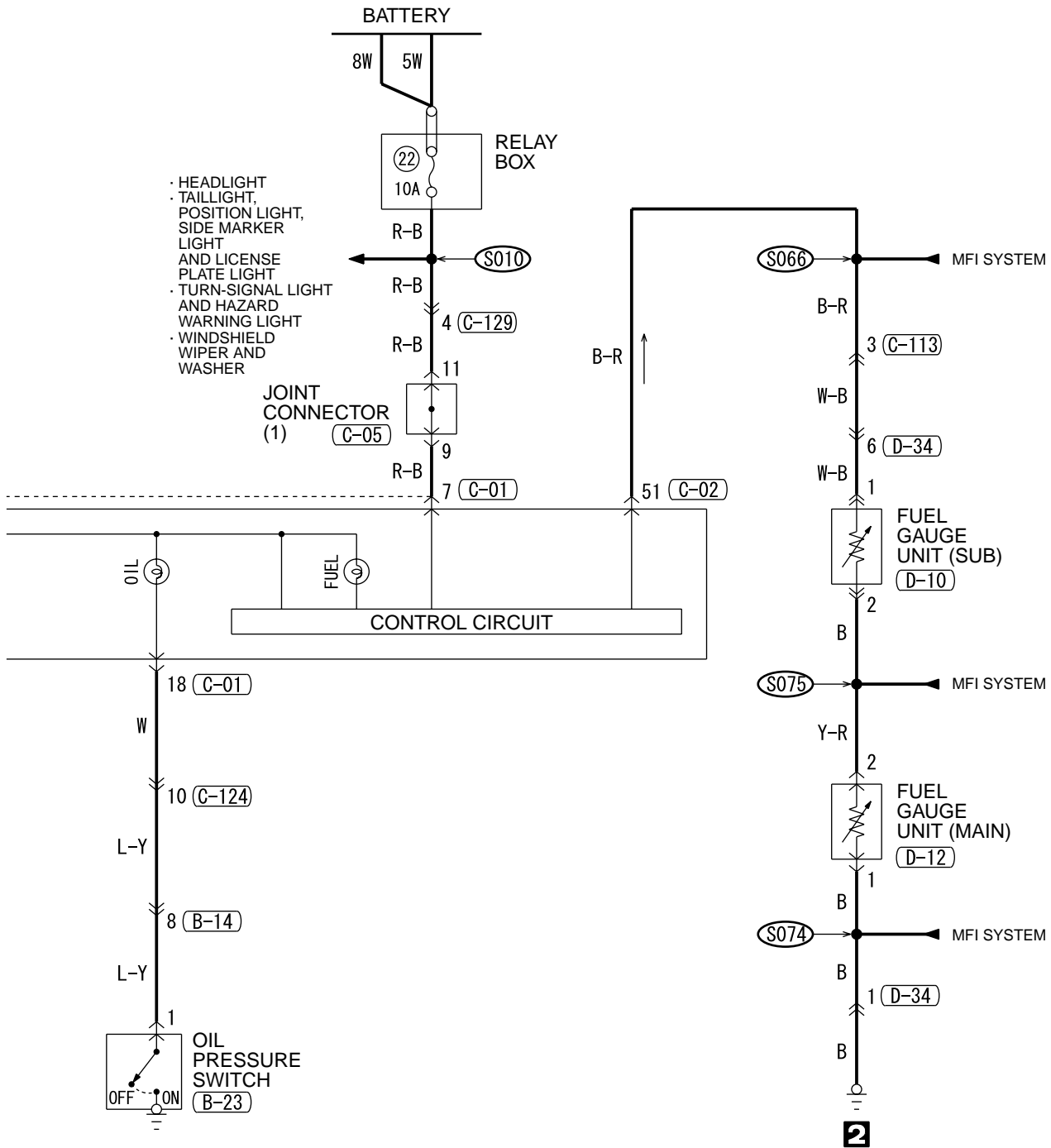

C-05

1	2	3	4	5	6	7	8	9	10	11
12	13	14	15	16	17	18	19	20	21	22

C-23

1	2	3	4	5	6	7	8	9	10	11
12	13	14	15	16	17	18	19	20	21	22

C-113

1	2	3	4	5	6	7	8	9	10	11	12	13
14	15	16	17	18	19	20	21	22	23	24	25	

C-124

1	2	3	4	5	6	7	8	9	10	11	12	13
14	15	16	17	18	19	20	21	22	23	24	25	

C-129

1	2	3	4	5	6	7	8	9	10	11	12	13
14	15	16	17	18	19	20	21	22	23	24	25	

WIRE COLOR CODE
 B : BLACK LG : LIGHT GREEN G : GREEN L : BLUE W : WHITE Y : YELLOW
 SB : SKY BLUE BR : BROWN O : ORANGE GR : GRAY R : RED P : PINK V : VIOLET

POWER WINDOWS

M1901004600659

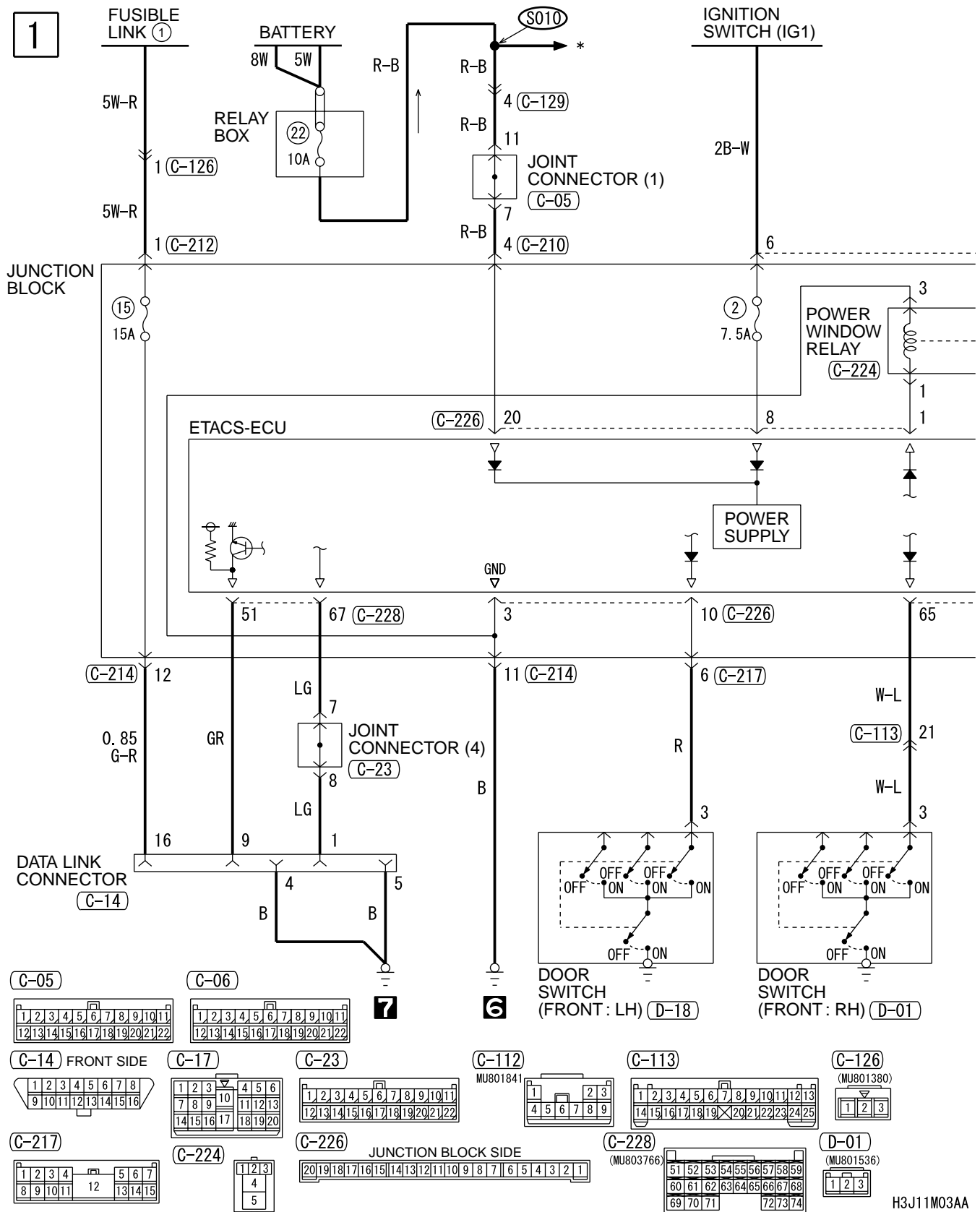

(C-05)

1	2	3	4	5	6	7	8	9	10	11
12	13	14	15	16	17	18	19	20	21	22

(C-06)

1	2	3	4	5	6	7	8	9	10	11
12	13	14	15	16	17	18	19	20	21	22

(C-14) FRONT SIDE

1	2	3	4	5	6	7	8
9	10	11	12	13	14	15	16

(C-17)

1	2	3	4	5	6
7	8	9	10	11	12
13	14	15	16	17	18
19	20	21	22	23	24

(C-23)

1	2	3	4	5	6	7	8	9	10	11
12	13	14	15	16	17	18	19	20	21	22

(C-112) MU801841

1	2	3
4	5	6
7	8	9

(C-113)

1	2	3	4	5	6	7	8	9	10	11	12	13
14	15	16	17	18	19	20	21	22	23	24	25	

(C-126) (MU801380)

1	2	3
---	---	---

(C-217)

1	2	3	4	5	6	7
8	9	10	11	12	13	14
15	16	17	18	19	20	21

(C-224)

1	2	3
4	5	6

(C-226) JUNCTION BLOCK SIDE

20	19	18	17	16	15	14	13	12	11	10	9	8	7	6	5	4	3	2	1
----	----	----	----	----	----	----	----	----	----	----	---	---	---	---	---	---	---	---	---

(C-228) (MU803766)

51	52	53	54	55	56	57	58	59
60	61	62	63	64	65	66	67	68
69	70	71	72	73	74			

(D-01) (MU801536)

1	2	3
---	---	---

H3J11M03AA

TSB Revision

2

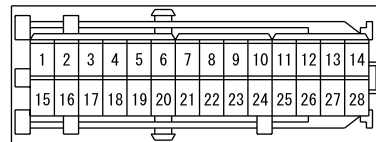
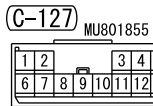
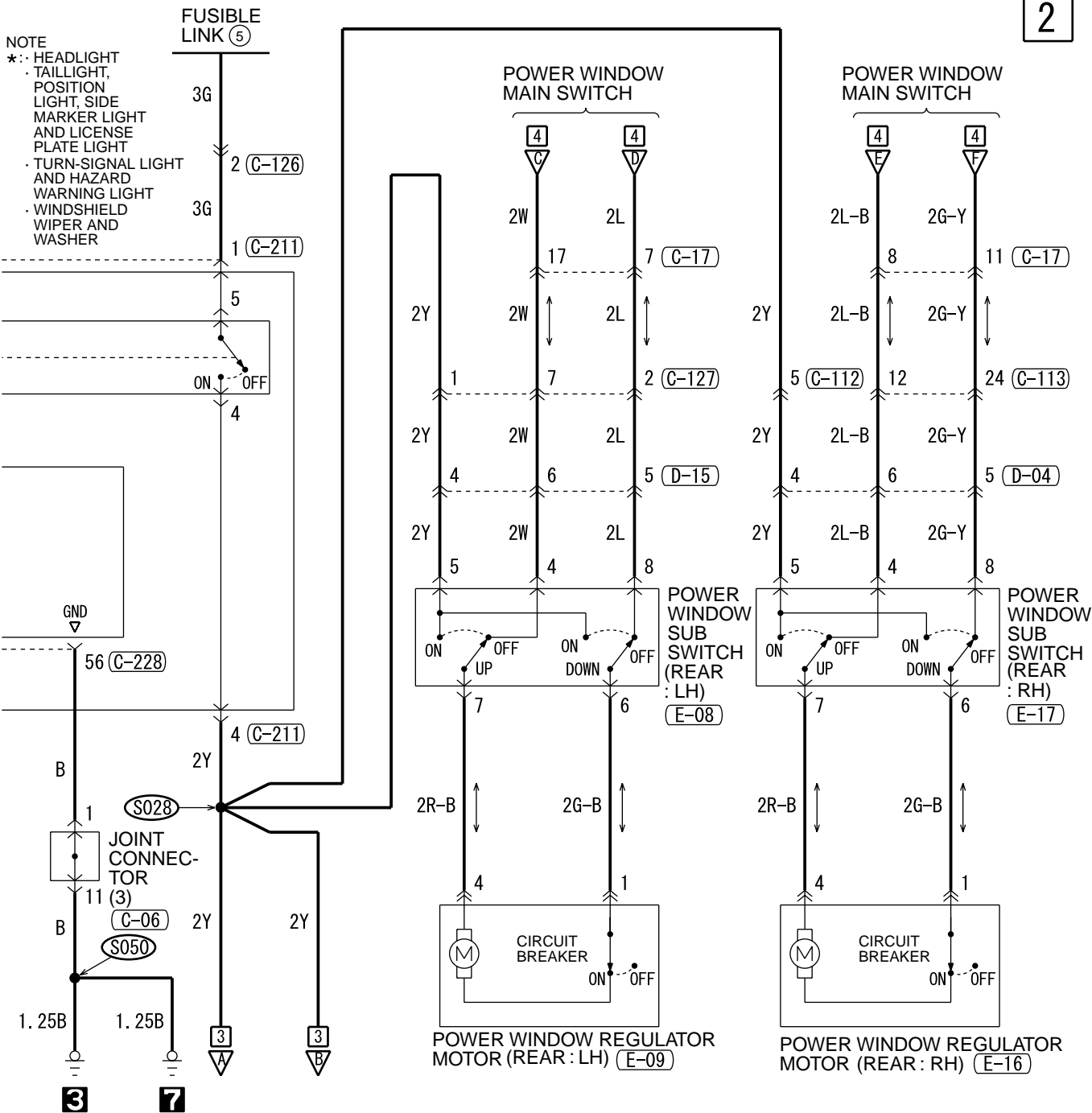

POWER WINDOWS (CONTINUED)

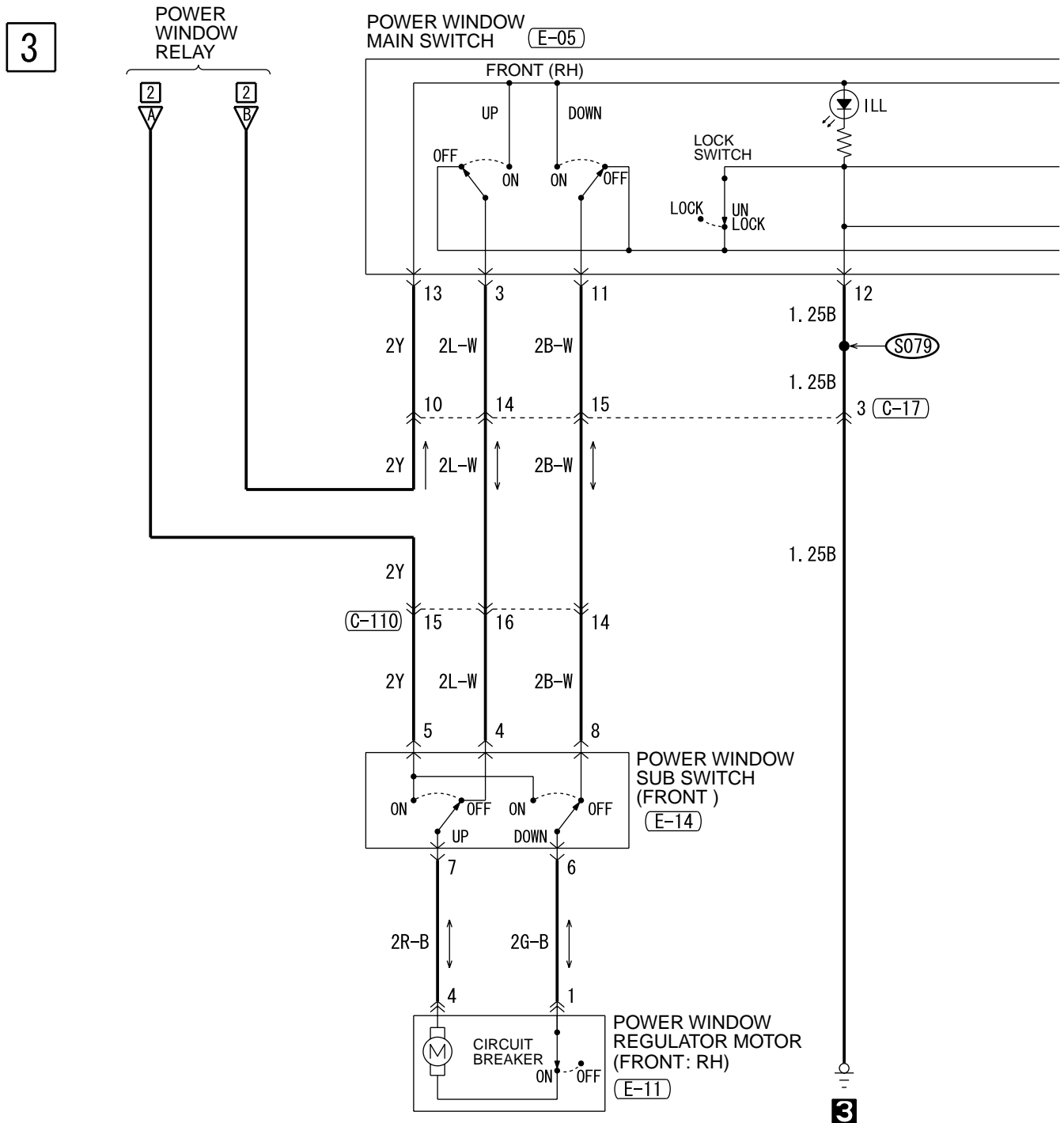

(C-17)

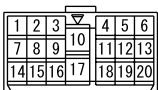

(C-110)

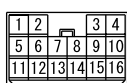

(E-02)



(E-05)

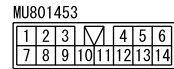

(E-11)



(E-14)

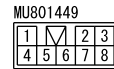

4

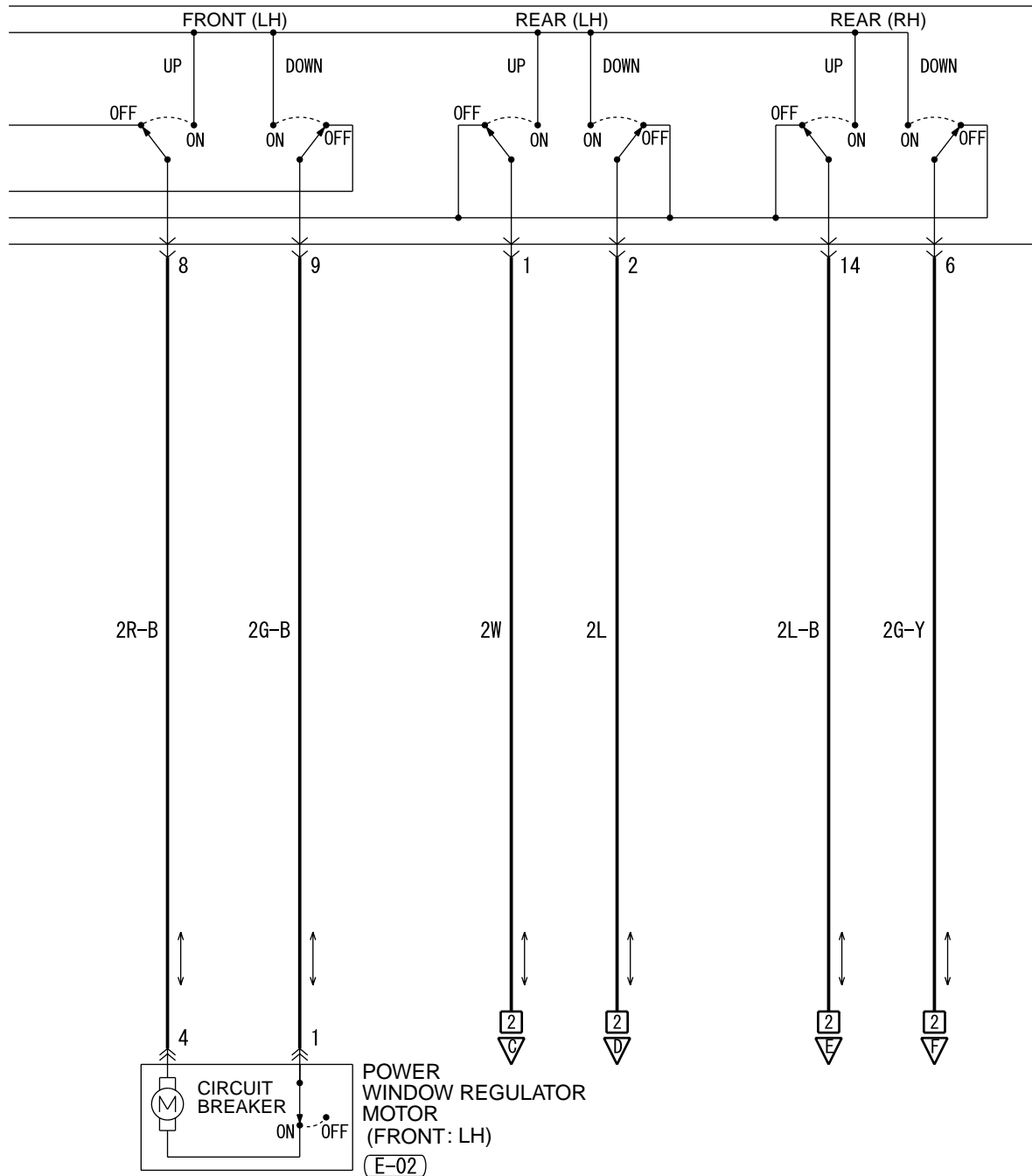

WIRE COLOR CODE
 B : BLACK LG : LIGHT GREEN G : GREEN L : BLUE W : WHITE Y : YELLOW
 SB : SKY BLUE BR : BROWN O : ORANGE GR : GRAY R : RED P : PINK V : VIOLET

H3J11M03BB

TSB Revision

CENTRAL DOOR LOCKING SYSTEM

M1901004700946

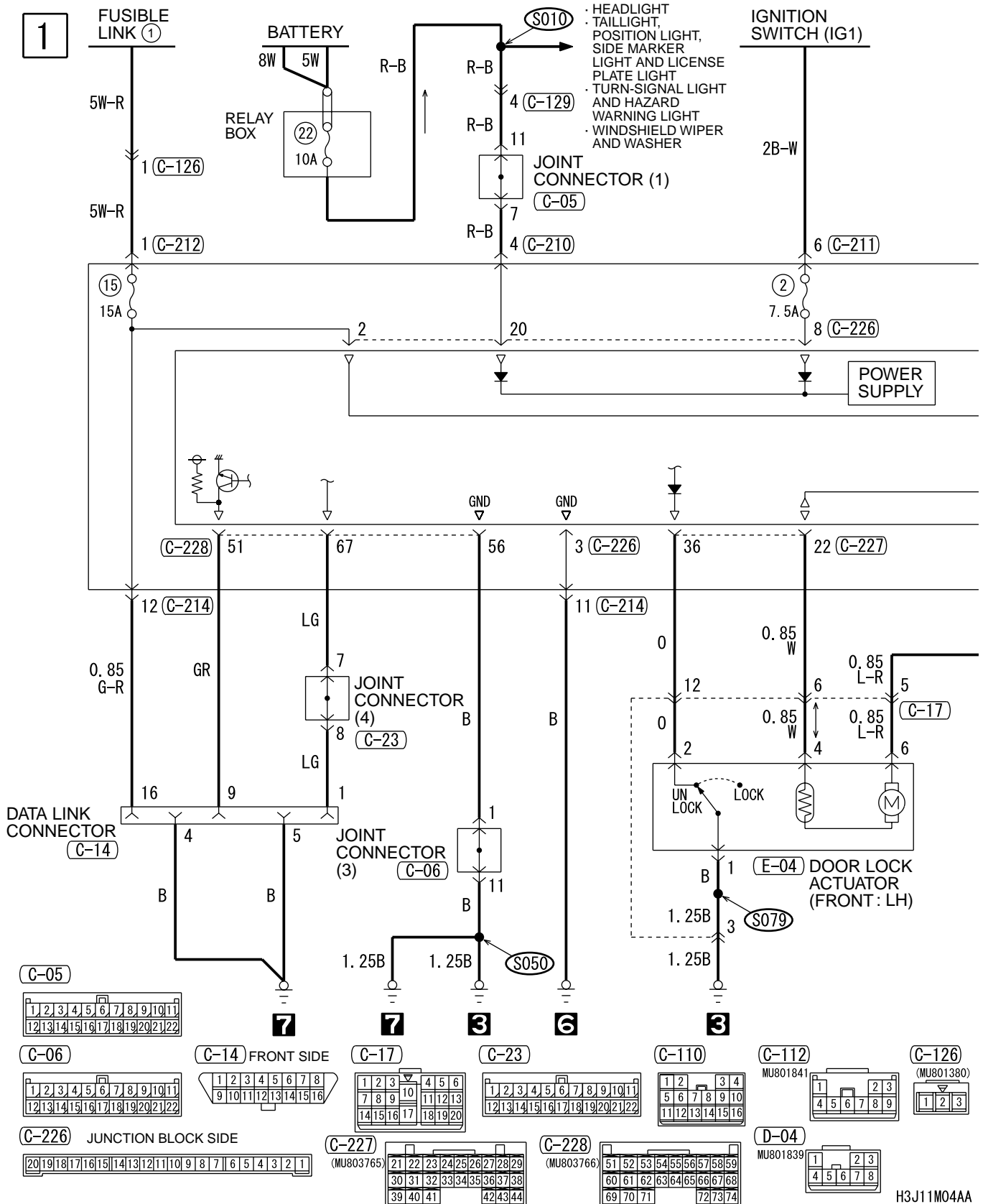

2

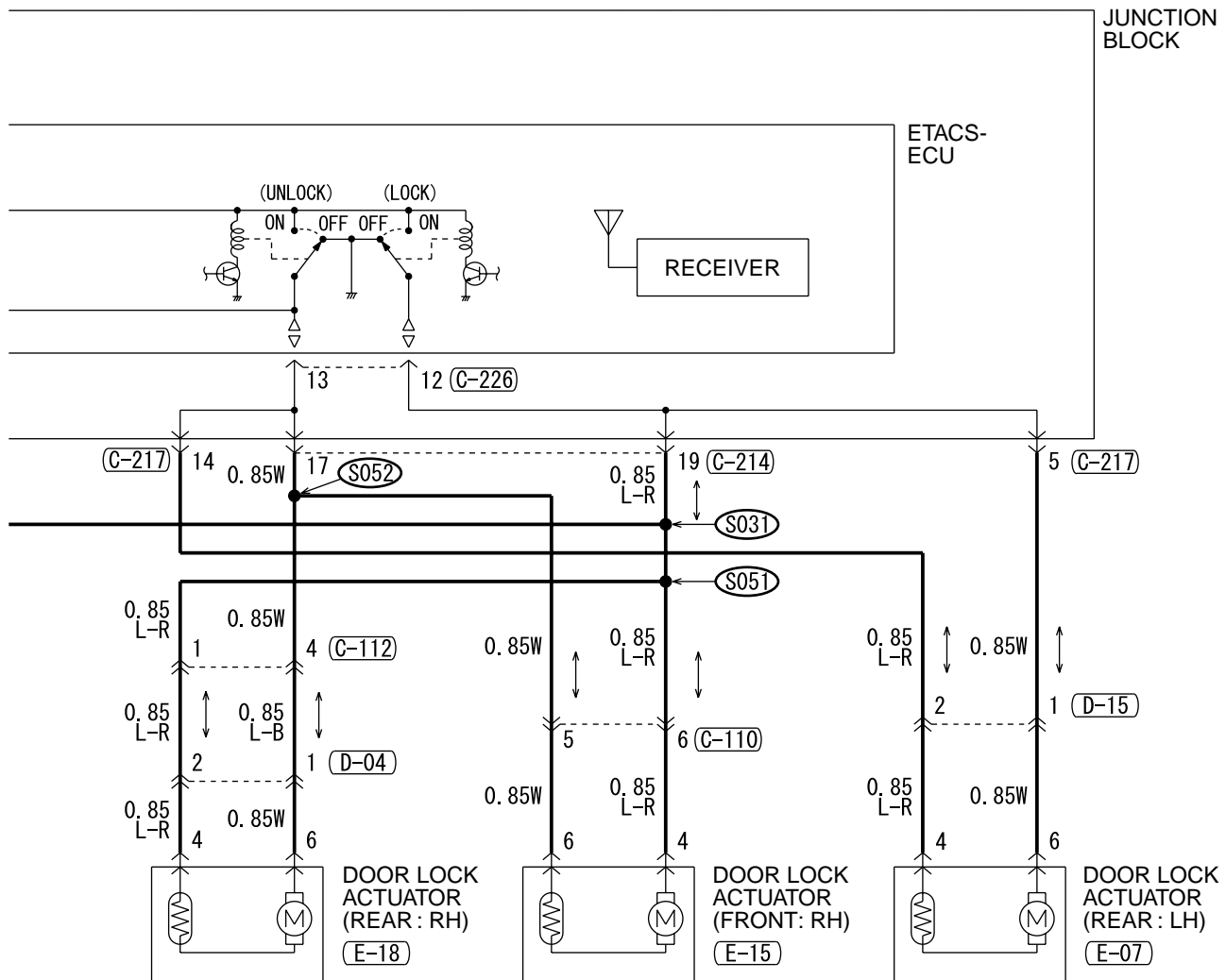
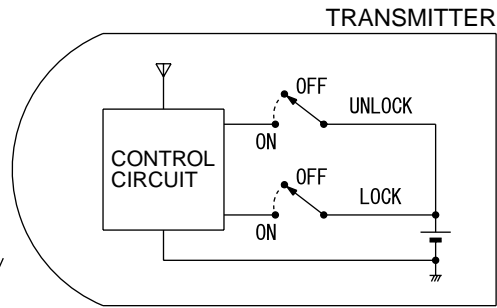

C-129

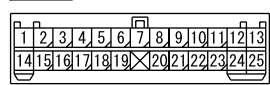

C-210

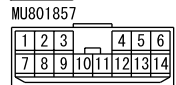

C-211



C-212



C-214

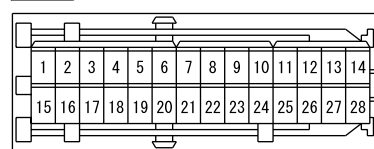

C-217

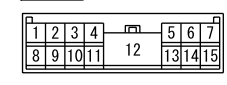

D-15

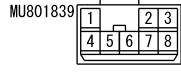

E-04



E-07



E-15



E-18



CENTRAL DOOR LOCKING SYSTEM (CONTINUED)

3

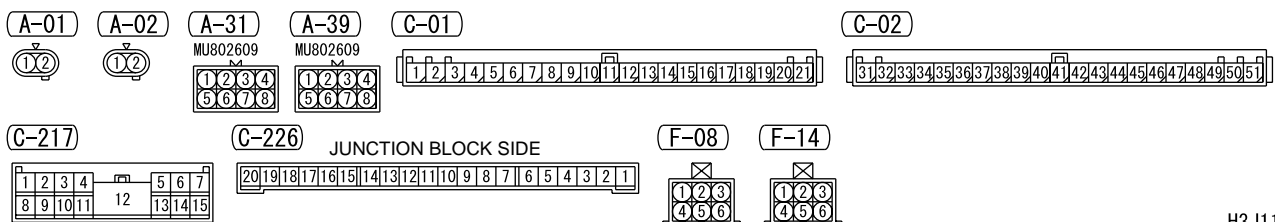
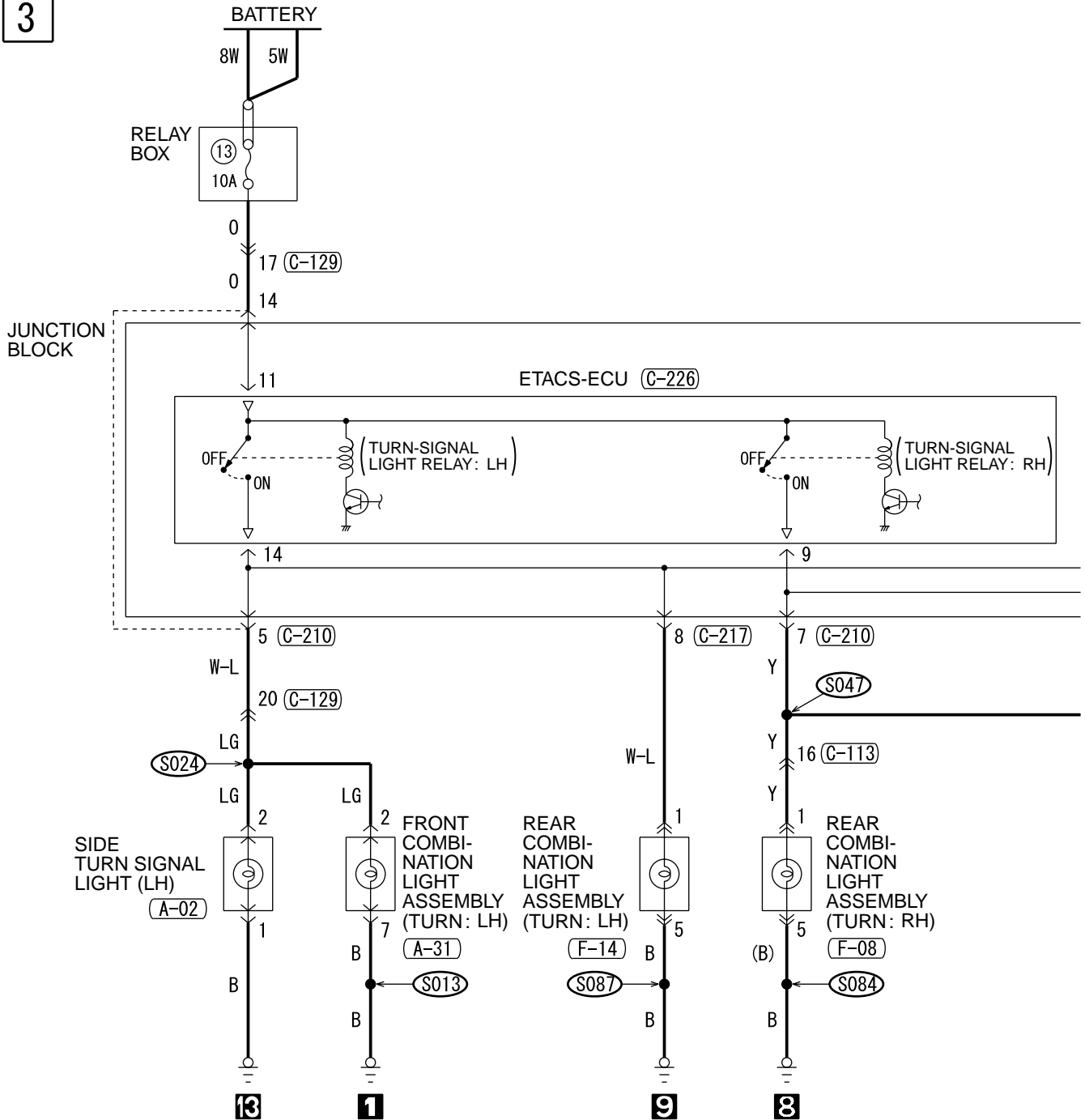

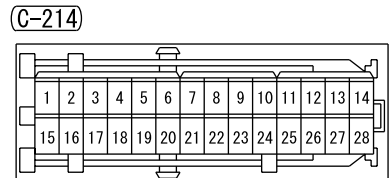
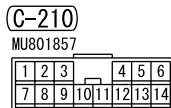
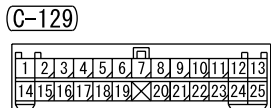
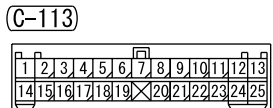
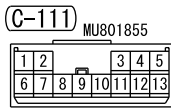
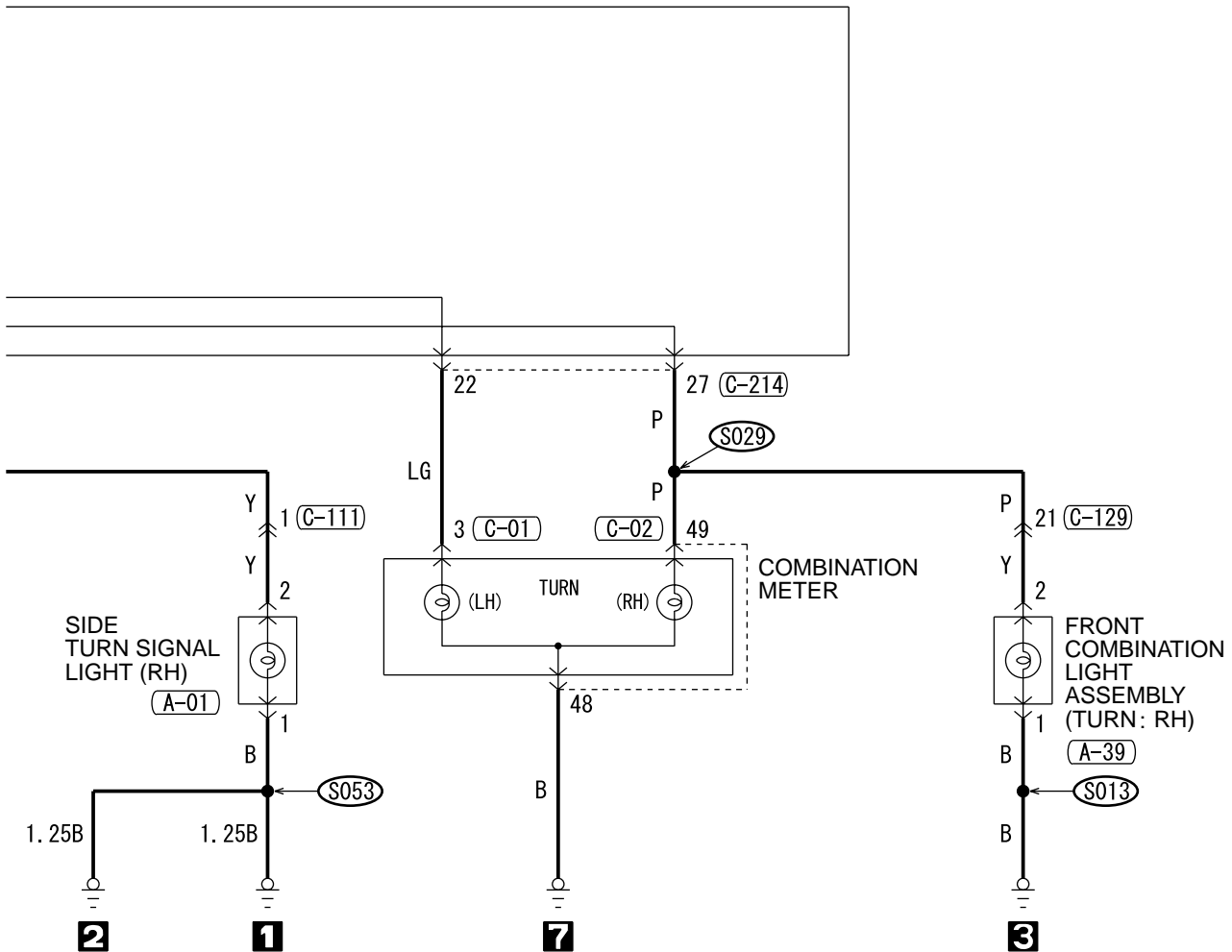

WIRE COLOR CODE
 B: BLACK LG: LIGHT GREEN G: GREEN L: BLUE
 BR: BROWN O: ORANGE GR: GRAY R: RED W: WHITE
 SB: SKY BLUE P: PINK Y: YELLOW V: VIOLET

H3J11M04BB

CENTRAL DOOR LOCKING SYSTEM (CONTINUED)

5

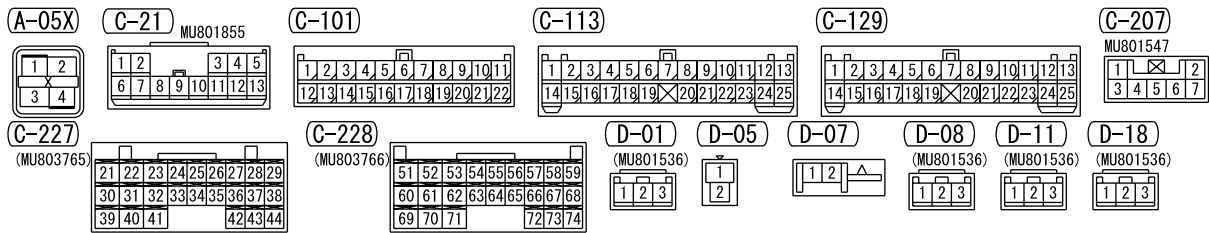
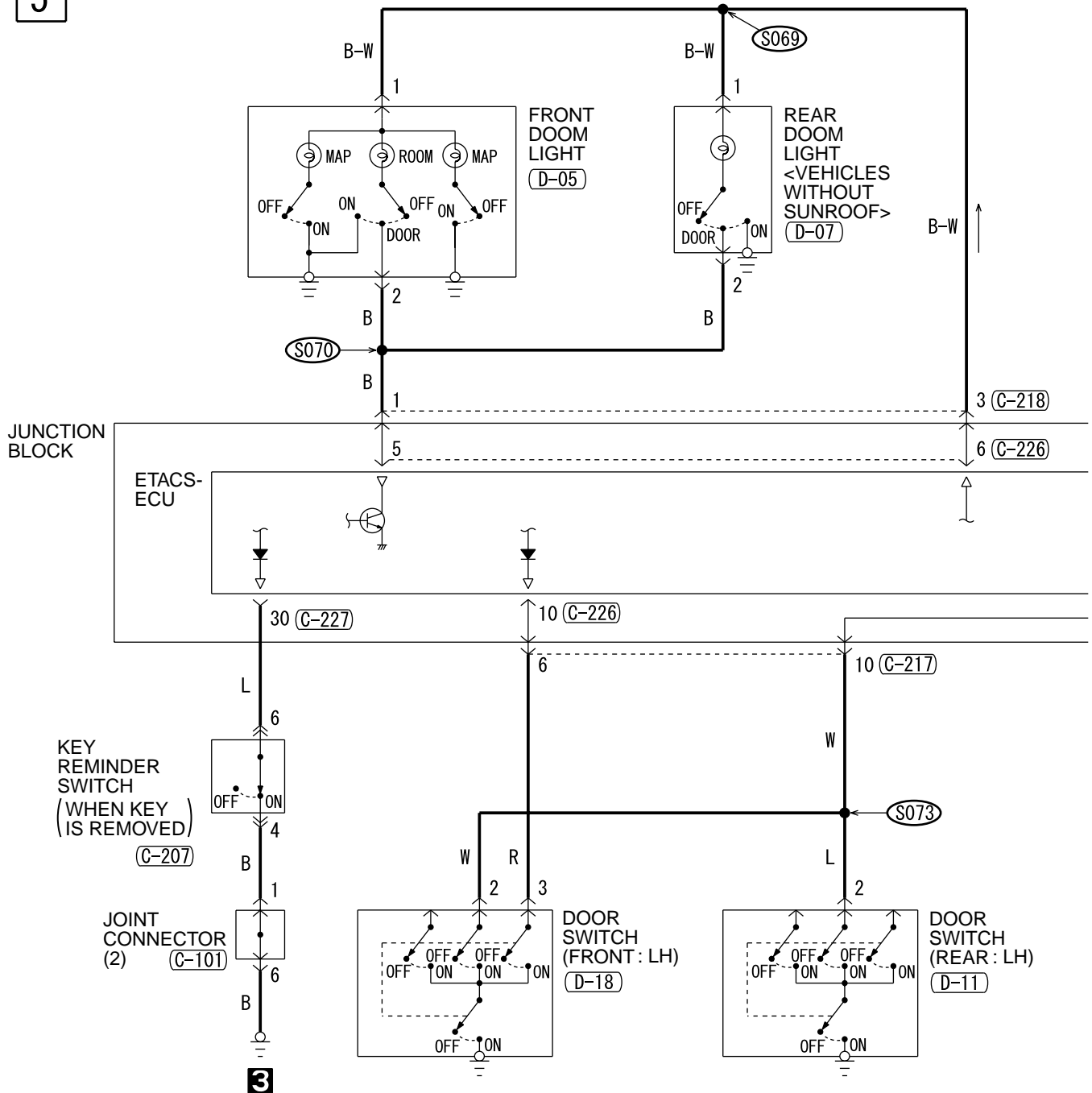

6

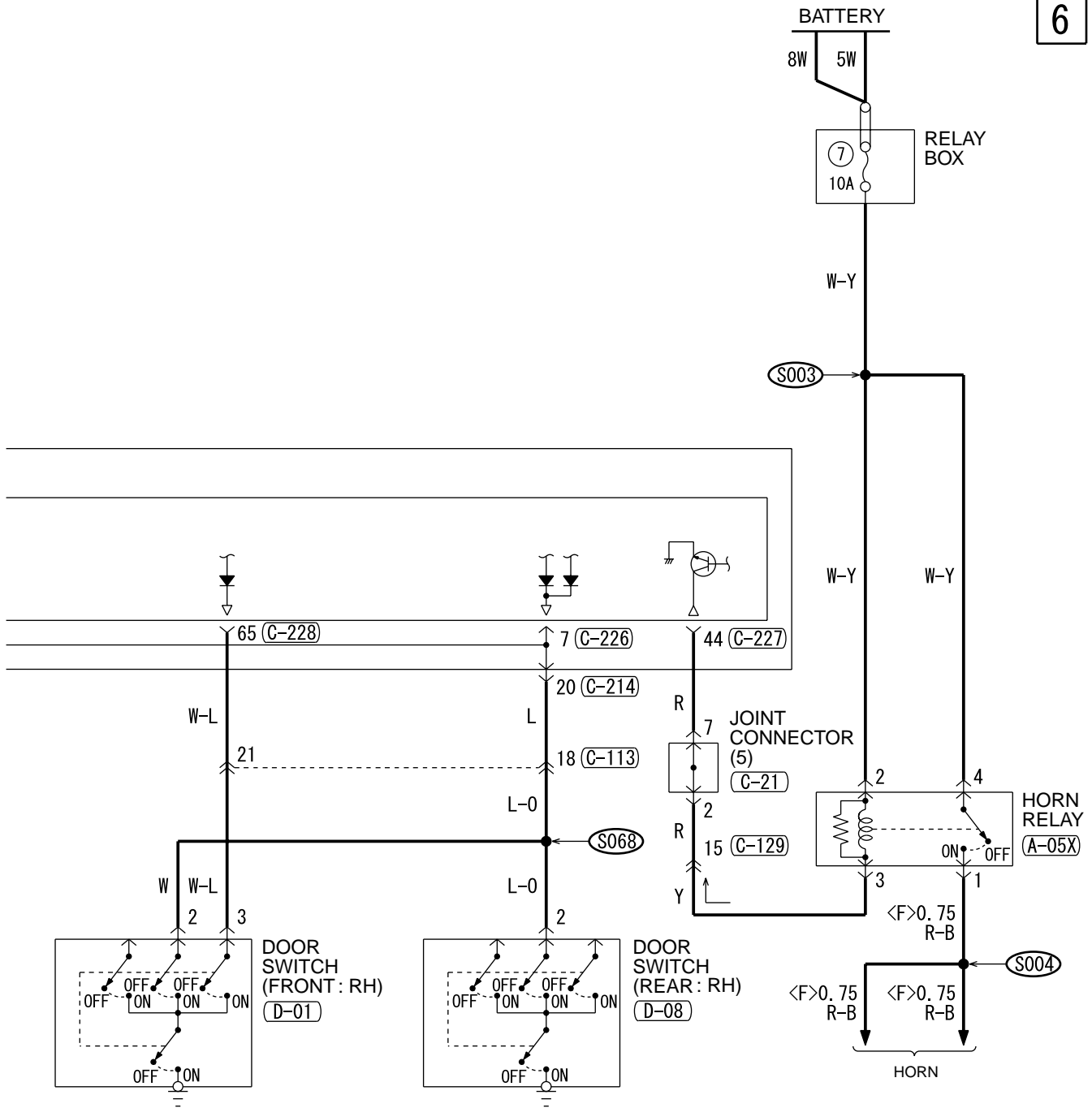

C-214

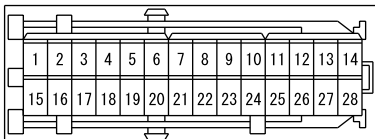

C-217

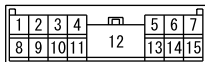

C-218



C-226

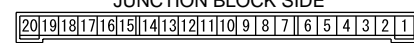

WIRE COLOR CODE

B : BLACK LG : LIGHT GREEN G : GREEN L : BLUE W : WHITE Y : YELLOW
SB : SKY BLUE BR : BROWN O : ORANGE GR : GRAY R : RED P : PINK V : VIOLET

H3J11M04CB

CENTRAL DOOR LOCKING SYSTEM (CONTINUED)

7

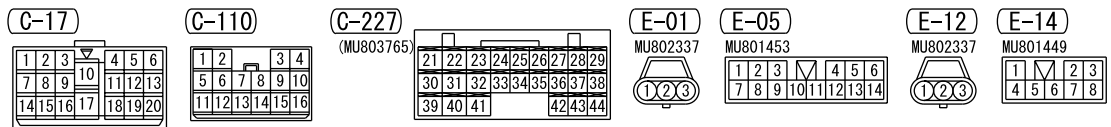
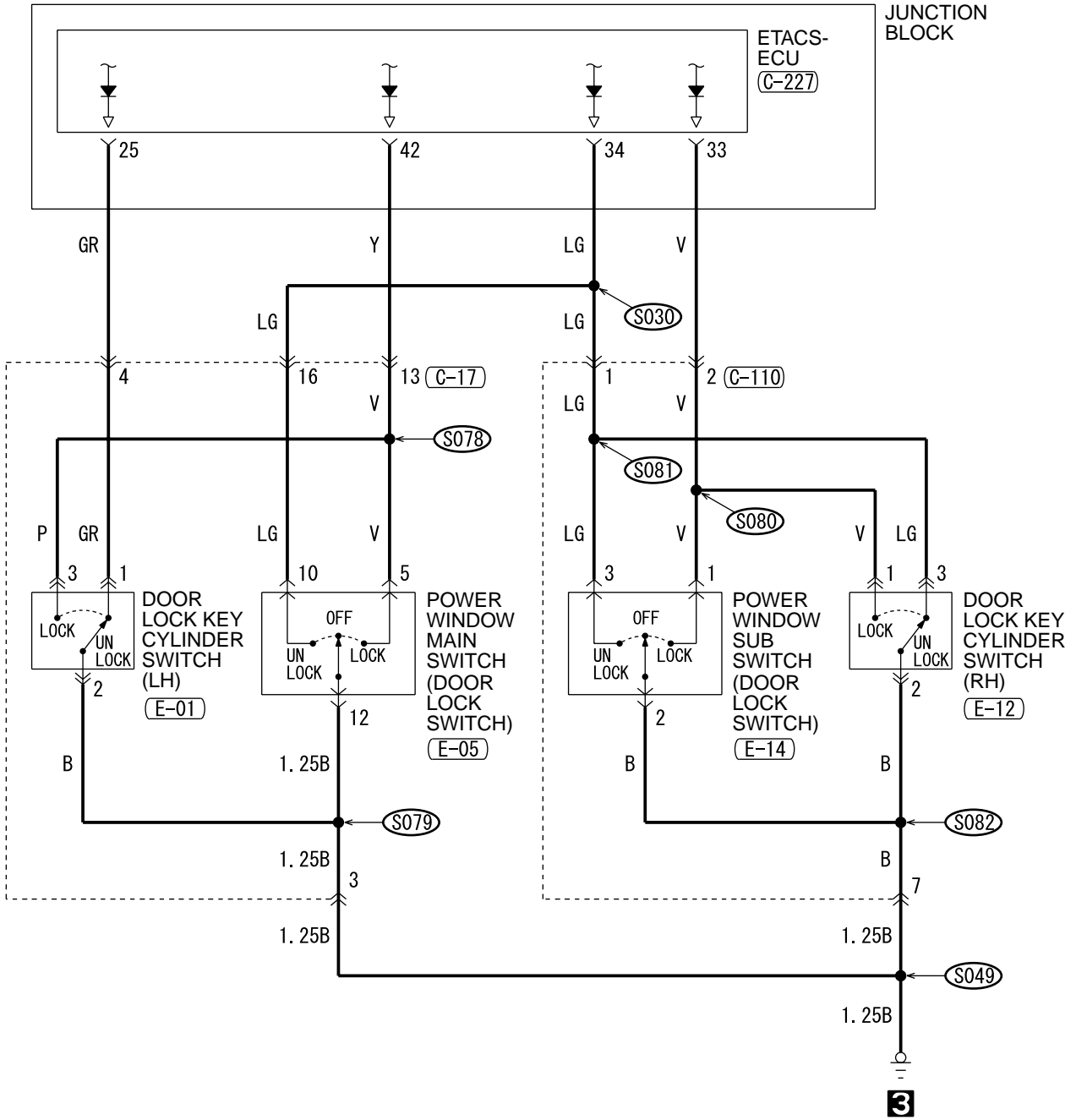

WIRE COLOR CODE
 B : BLACK LG : LIGHT GREEN G : GREEN L : BLUE W : WHITE Y : YELLOW
 SB : SKY BLUE BR : BROWN O : ORANGE GR : GRAY R : RED P : PINK V : VIOLET

NOTES

MANUAL AIR CONDITIONING SYSTEM

M1901005500882

1

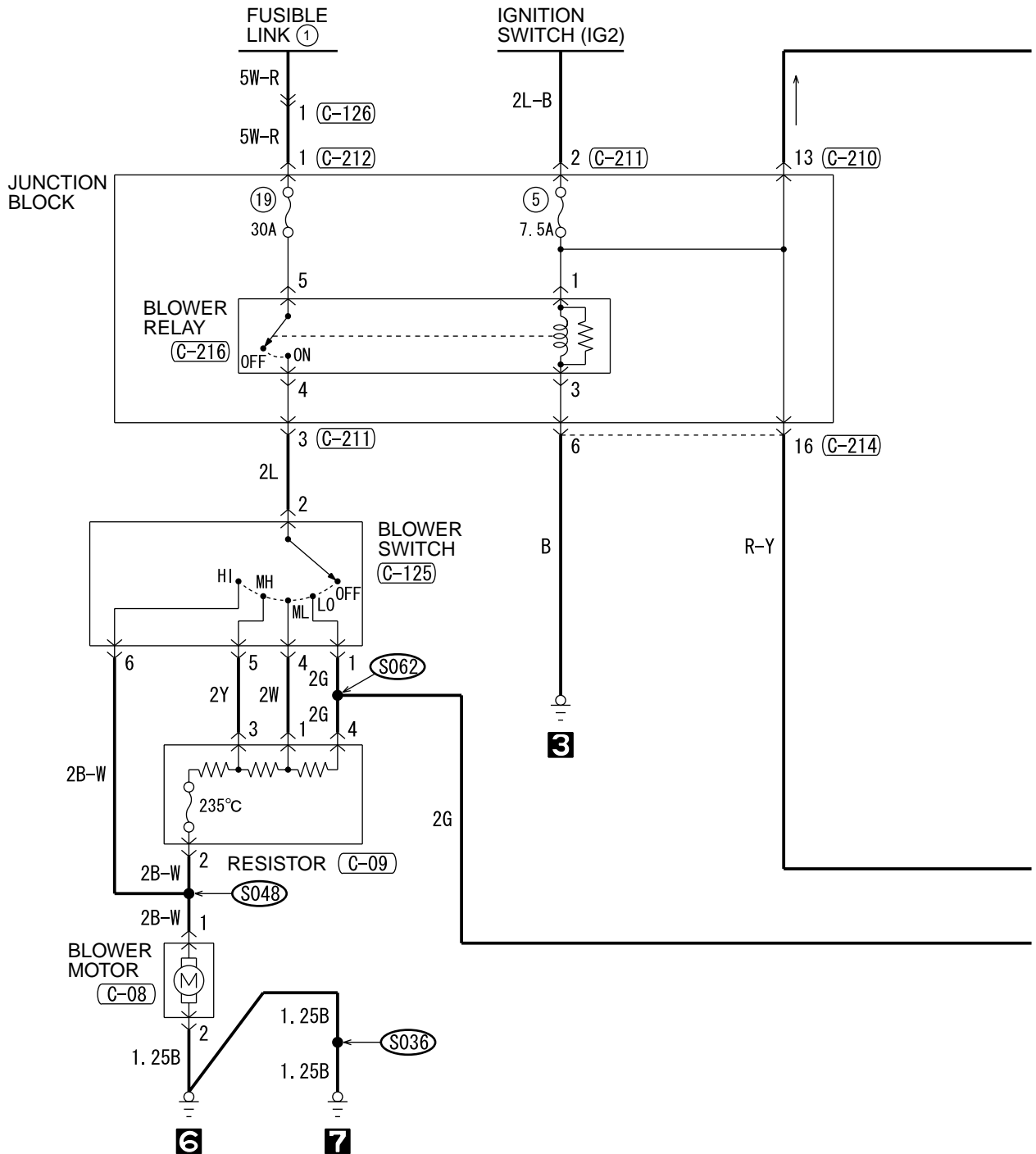

C-05

C-06

C-07

C-08

C-09

C-129

C-210

C-211

C-212

C-214

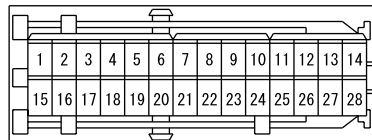
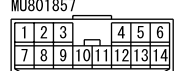
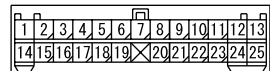
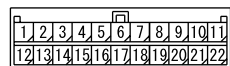
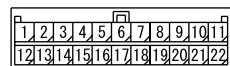

H3J12M01AA

TSB Revision

2

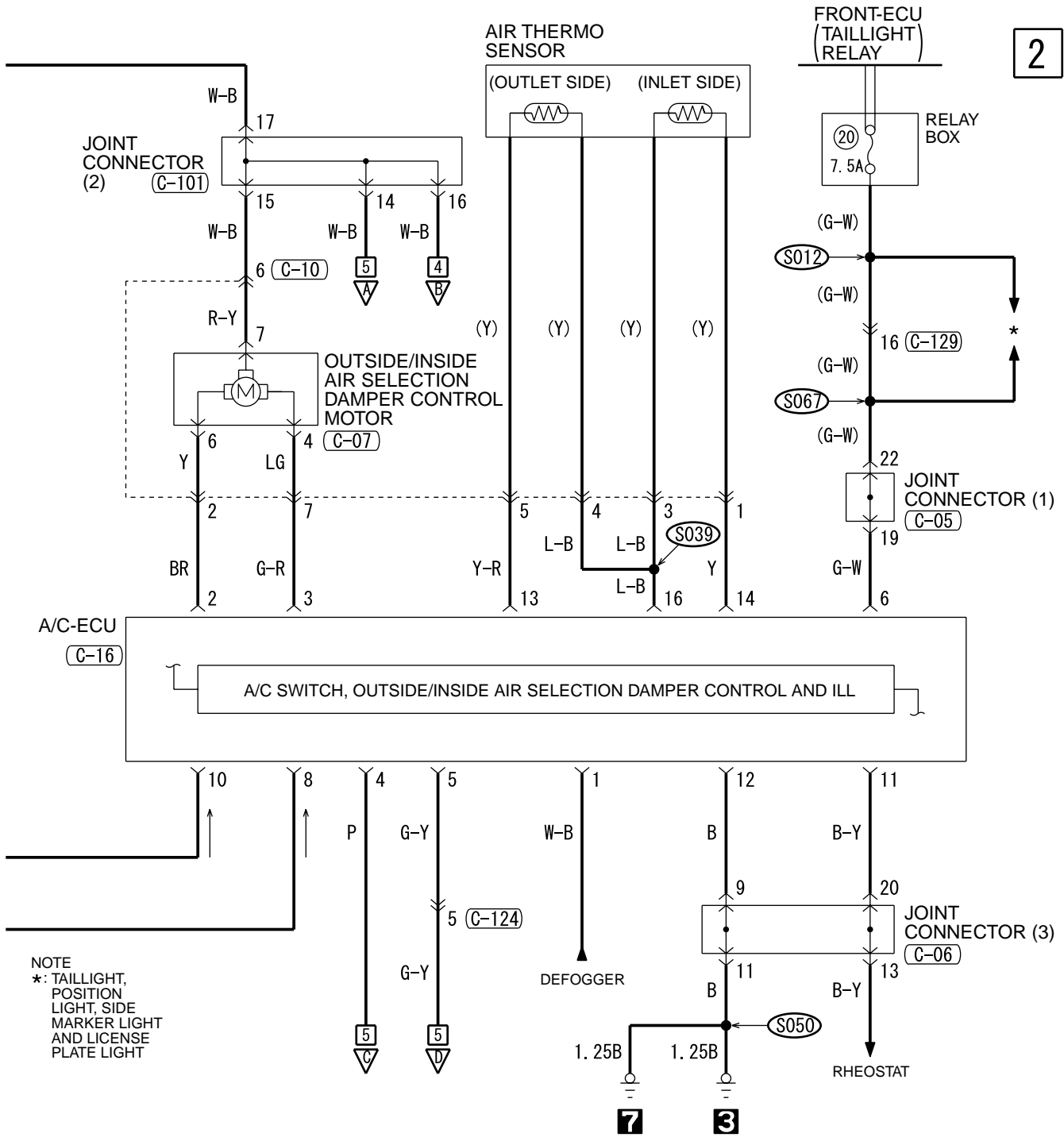

C-10

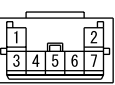

C-16

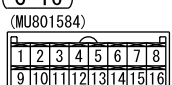

C-101

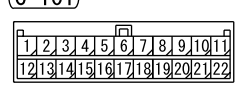

C-124

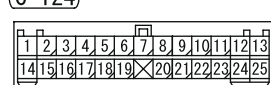

C-125



C-126



C-216



WIRE COLOR CODE
 B : BLACK LG : LIGHT GREEN G : GREEN L : BLUE W : WHITE Y : YELLOW
 SB : SKY BLUE BR : BROWN O : ORANGE GR : GRAY R : RED P : PINK V : VIOLET

MANUAL AIR CONDITIONING SYSTEM (CONTINUED)

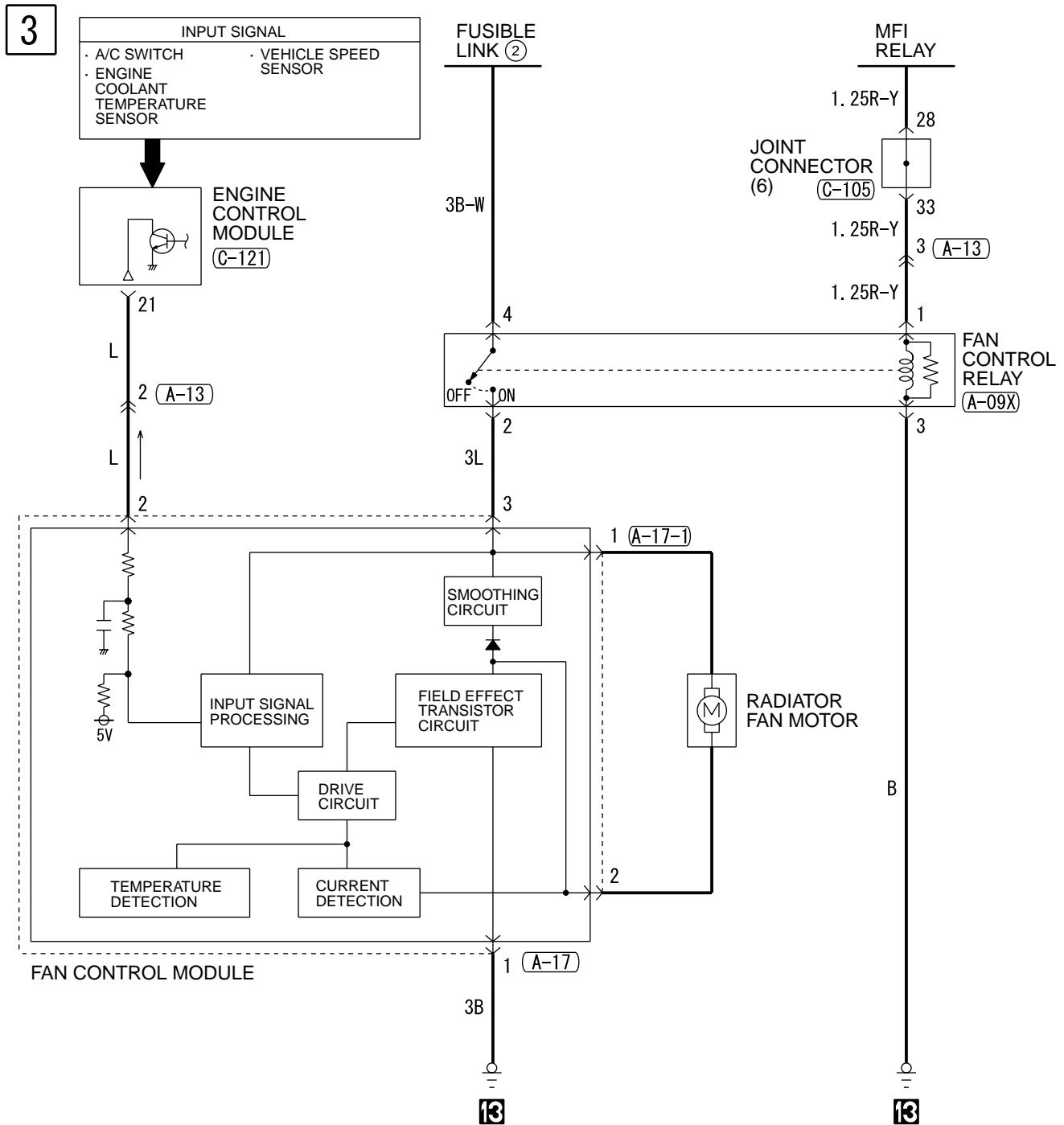

(A-06X)

(A-07X)

(A-09X)

(A-13)

(A-17)

(A-17-1)

(A-29)

(A-34)

(A-35)

(C-105)

(C-119)



4

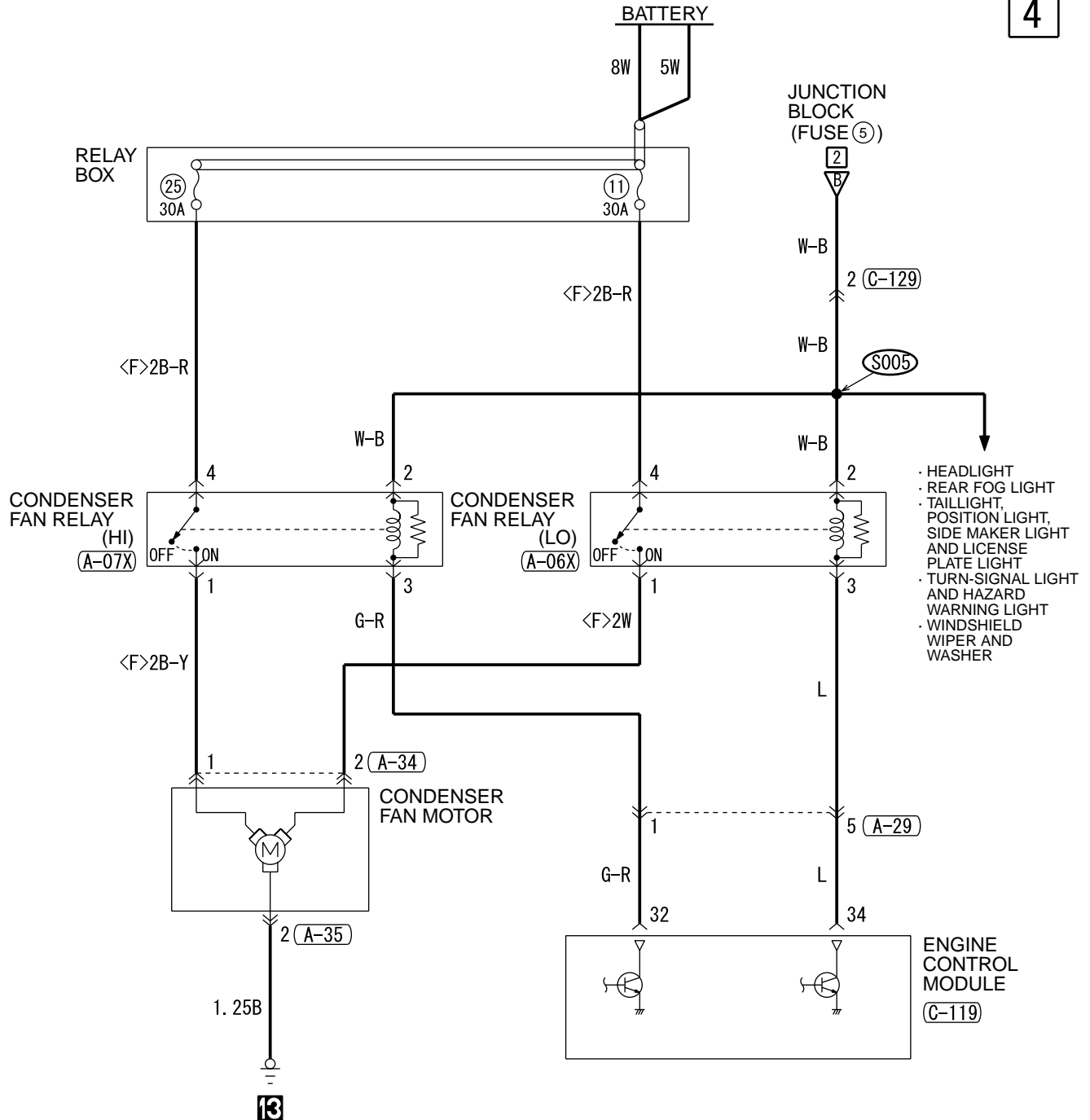

- HEADLIGHT
- REAR FOG LIGHT
- TAILLIGHT, POSITION LIGHT, SIDE MAKER LIGHT AND LICENSE PLATE LIGHT
- TURN-SIGNAL LIGHT AND HAZARD WARNING LIGHT
- WINDSHIELD WIPER AND WASHER

C-121 (MU801824)

1	2	3	4	5	6	7	8	9	10	11	12	13
14	15	16	17	18	19	20	21	22	23	24	25	26

C-129

1	2	3	4	5	6	7	8	9	10	11	12	13
14	15	16	17	18	19	20	21	22	23	24	25	

WIRE COLOR CODE
 B : BLACK LG : LIGHT GREEN G : GREEN L : BLUE W : WHITE Y : YELLOW
 SB : SKY BLUE BR : BROWN O : ORANGE GR : GRAY R : RED P : PINK V : VIOLET

MANUAL AIR CONDITIONING SYSTEM (CONTINUED)

5

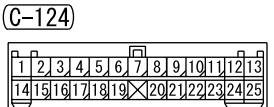
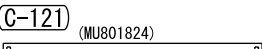
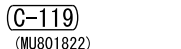
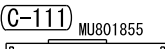
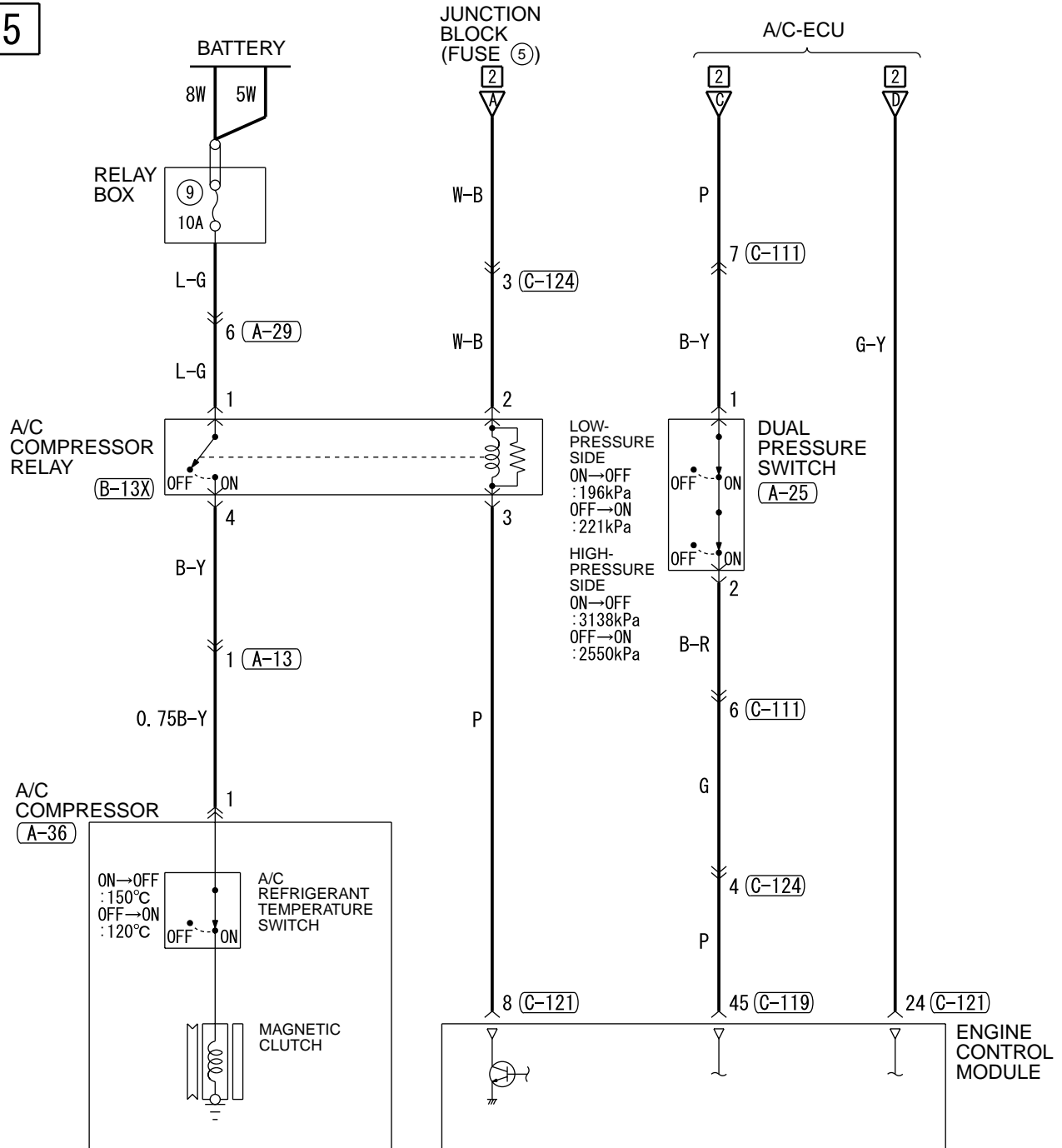

WIRE COLOR CODE
 B : BLACK LG : LIGHT GREEN G : GREEN L : BLUE
 BR : BROWN O : ORANGE GR : GRAY R : RED W : WHITE
 SB : SKY BLUE P : PINK Y : YELLOW V : VIOLET

M1901006500539

REMOTE CONTROLLED MIRROR

1

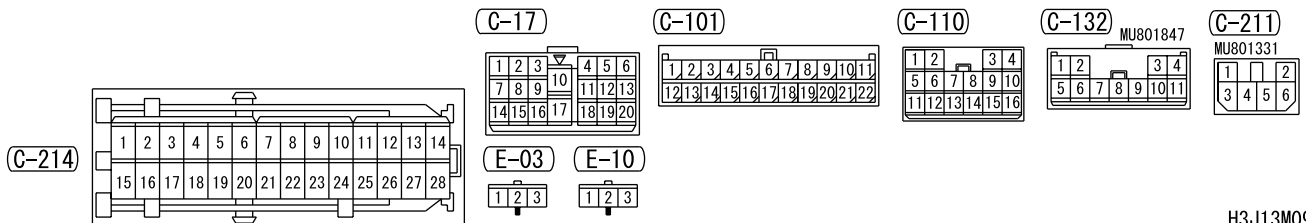
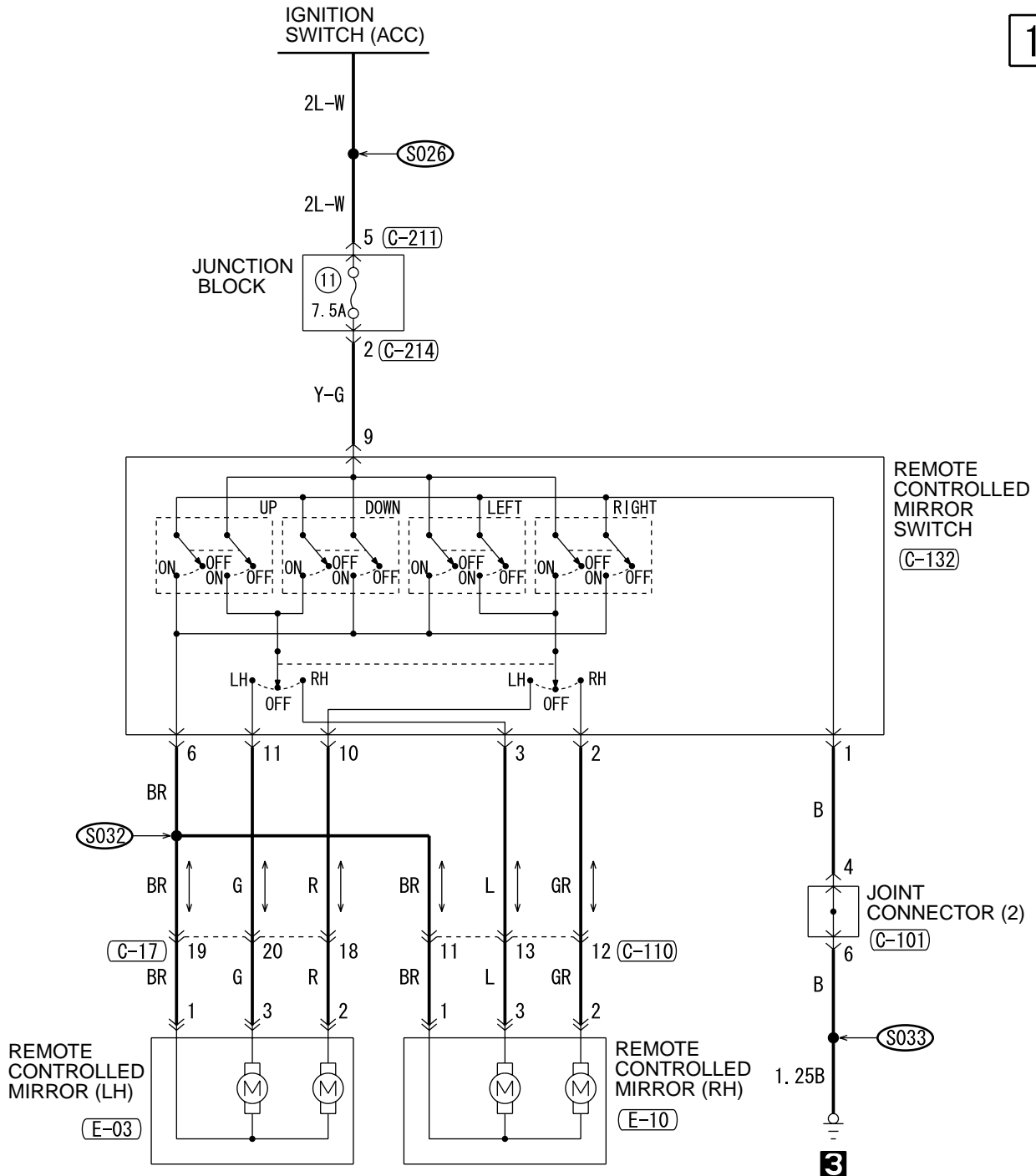

H3J13M09AA

TSB Revision

WINDSHIELD WIPER AND WASHER

M1901006100519

1

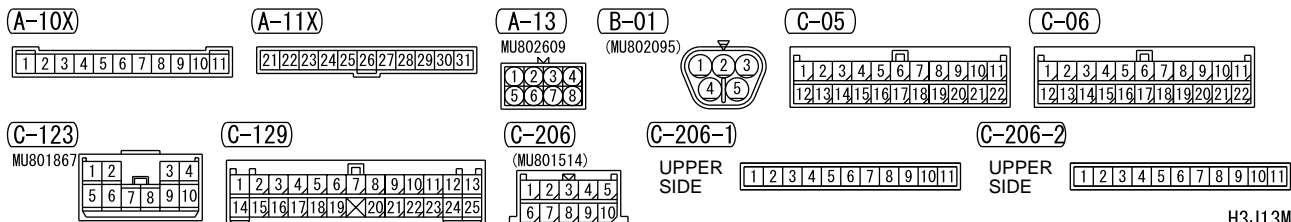
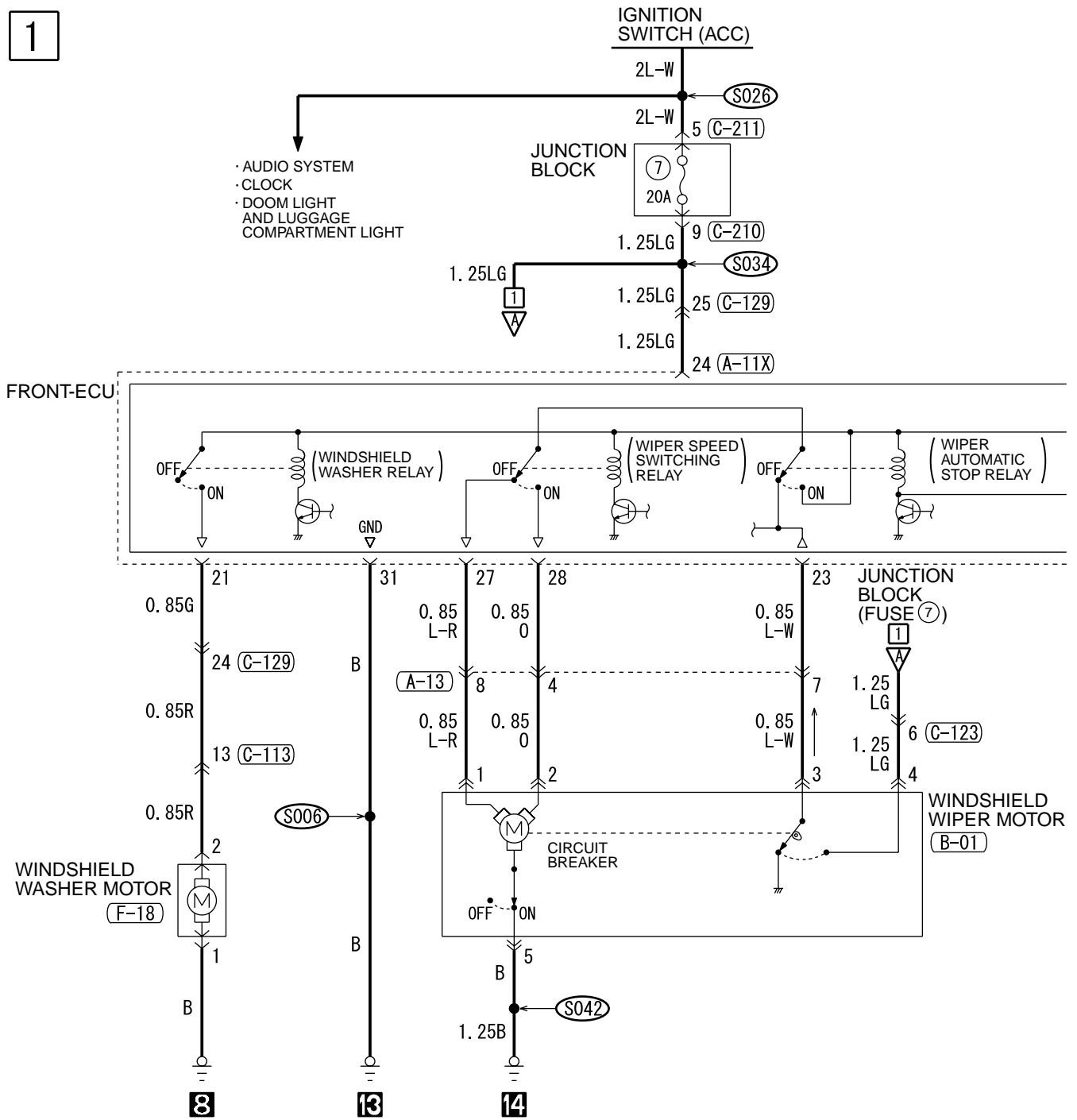

H3J13M06AA

2

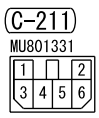
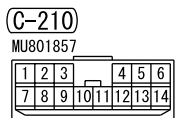
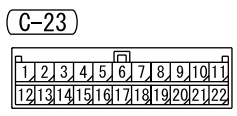
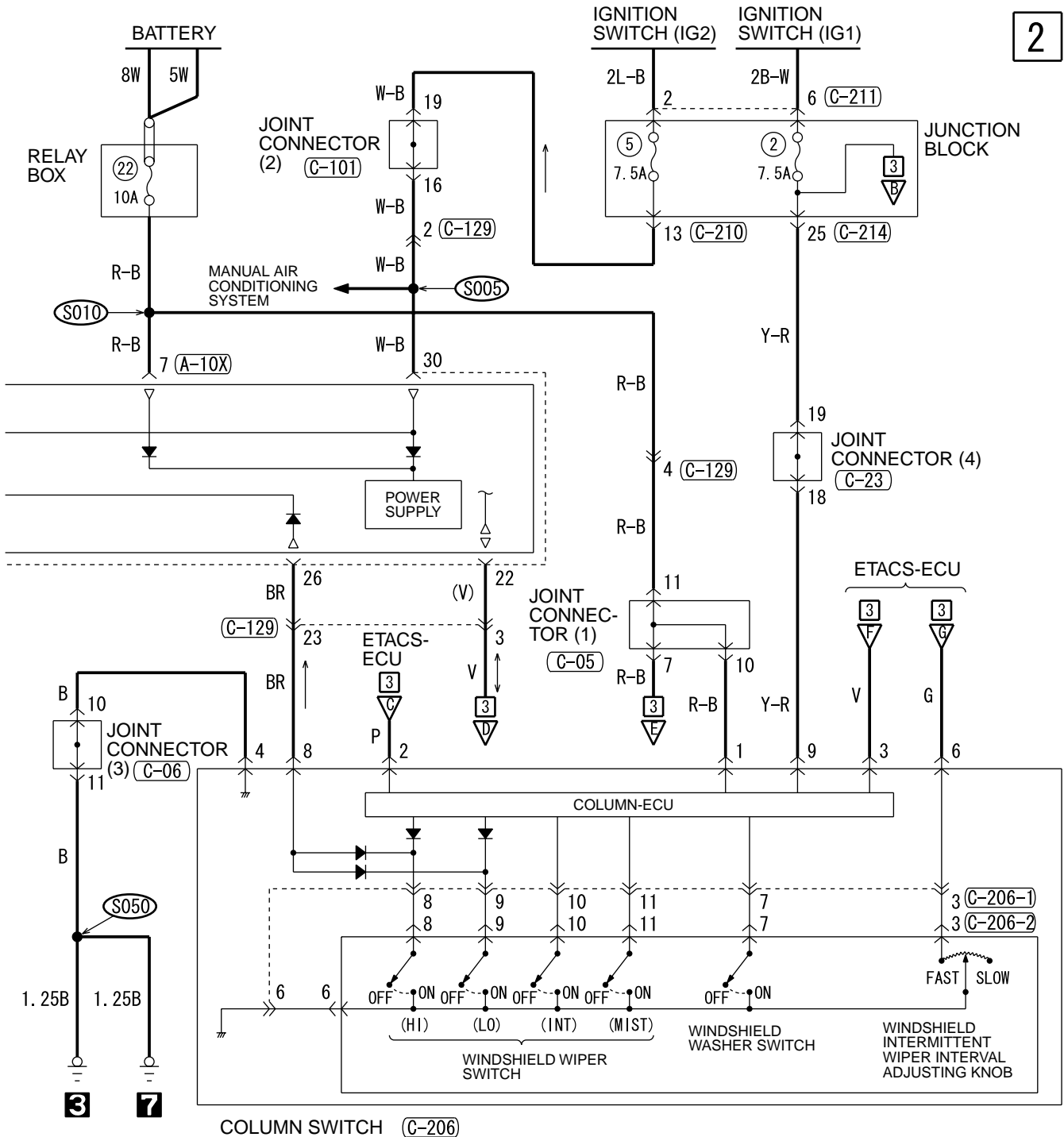

C-214

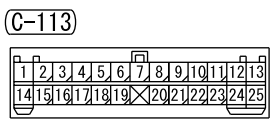
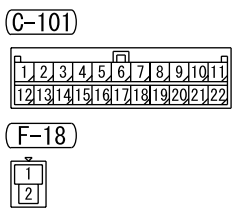
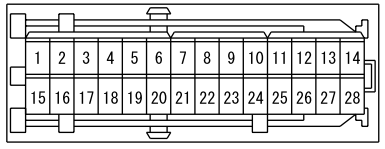

WINDSHIELD WIPER AND WASHER (CONTINUED)

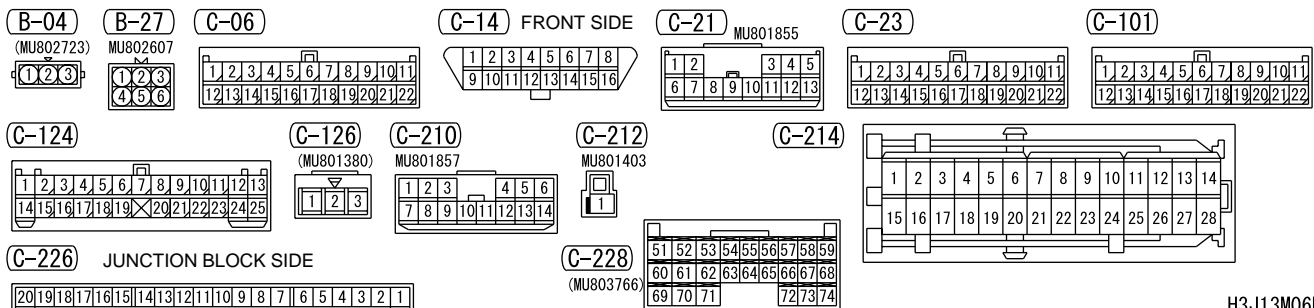
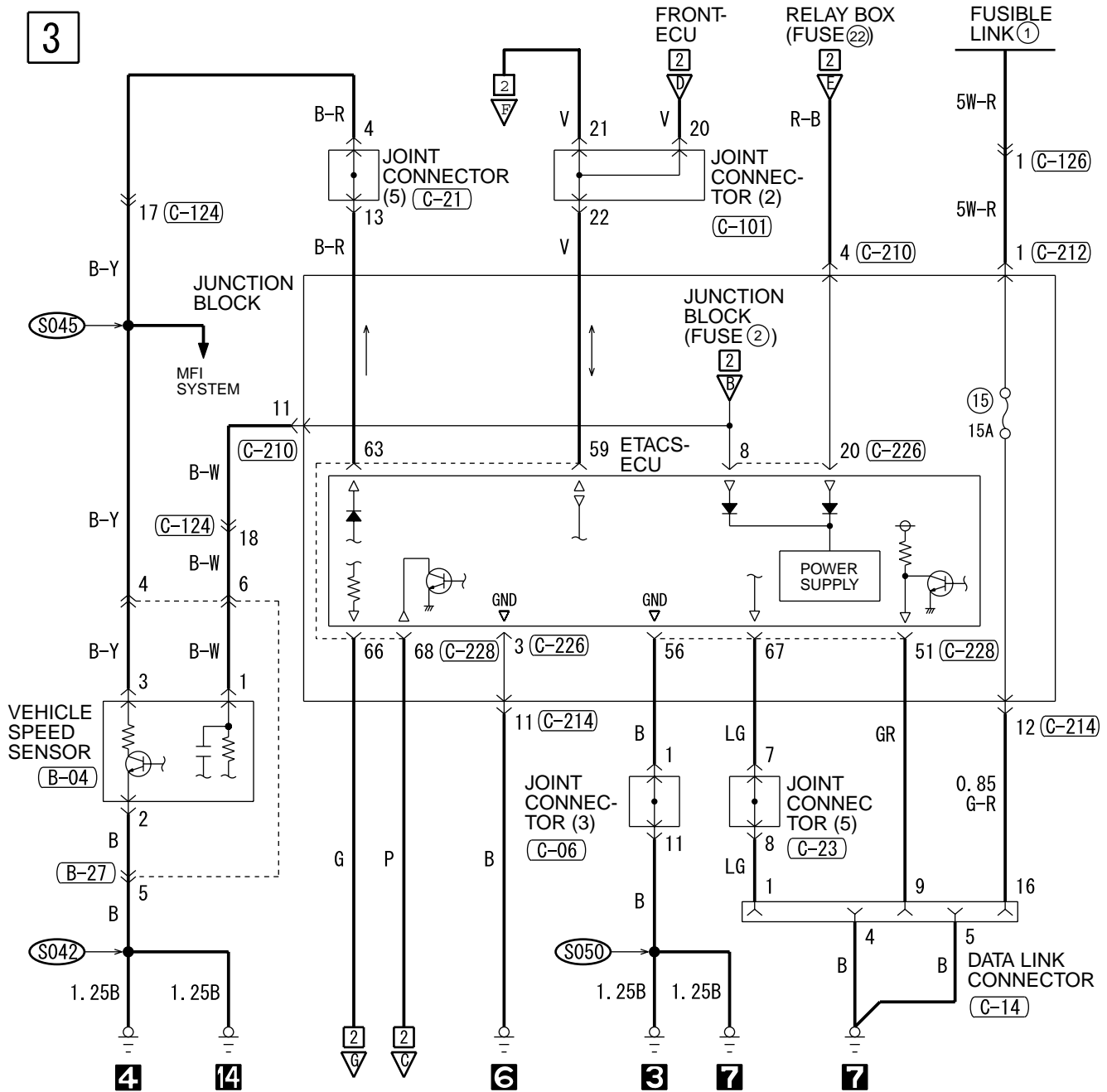

REAR WINDOW DEFOGGER

1

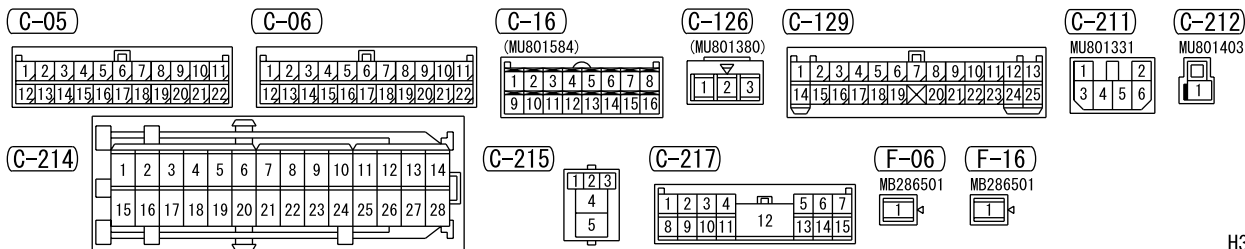
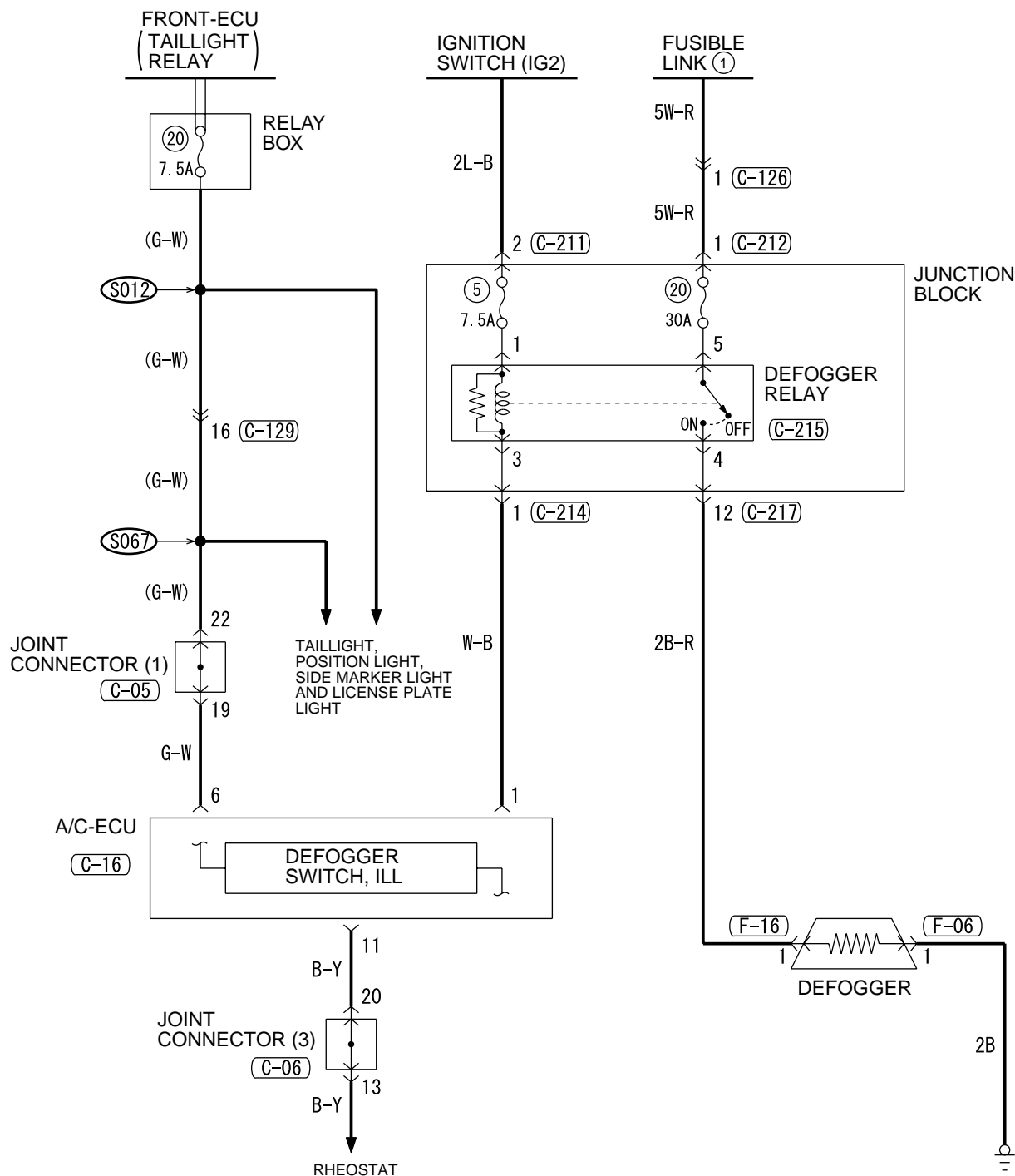

REAR WIPER AND WASHER

M1901006200453

1

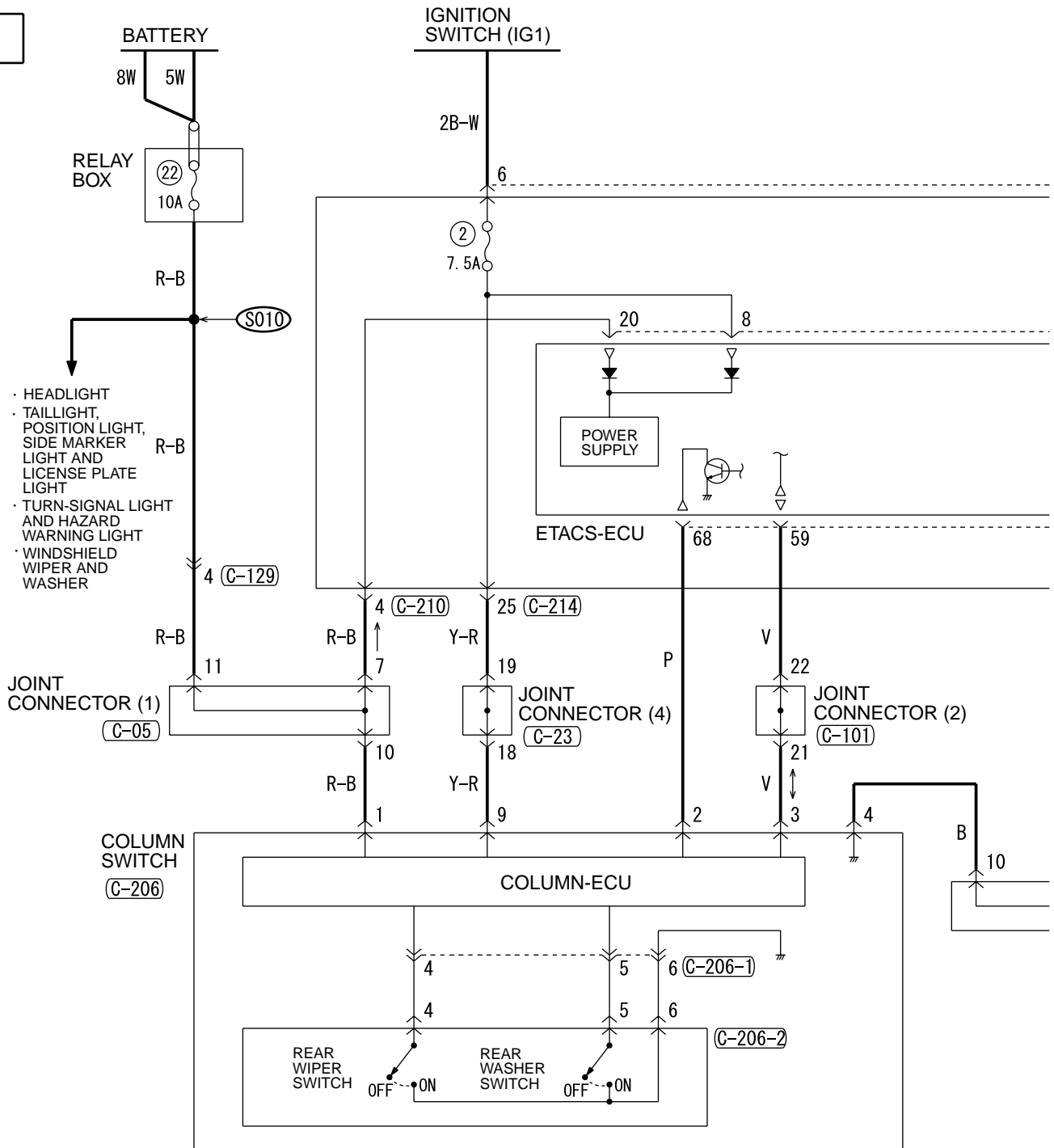

- HEADLIGHT
- TAILLIGHT, POSITION LIGHT, SIDE MARKER LIGHT AND LICENSE PLATE LIGHT
- TURN-SIGNAL LIGHT AND HAZARD WARNING LIGHT
- WINDSHIELD WIPER AND WASHER

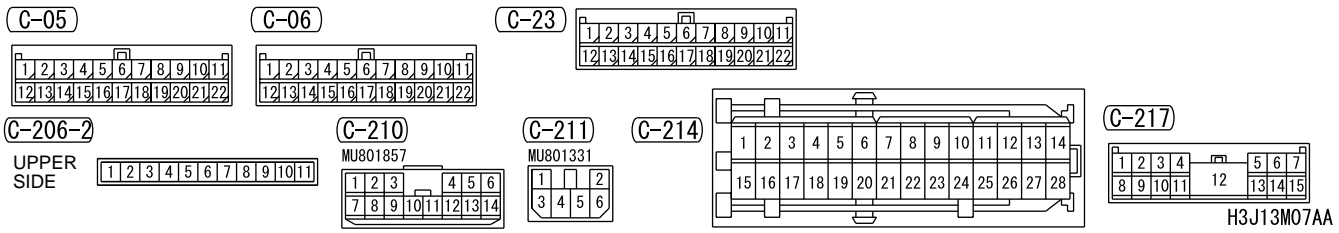

H3J13M07AA

TSB Revision

2

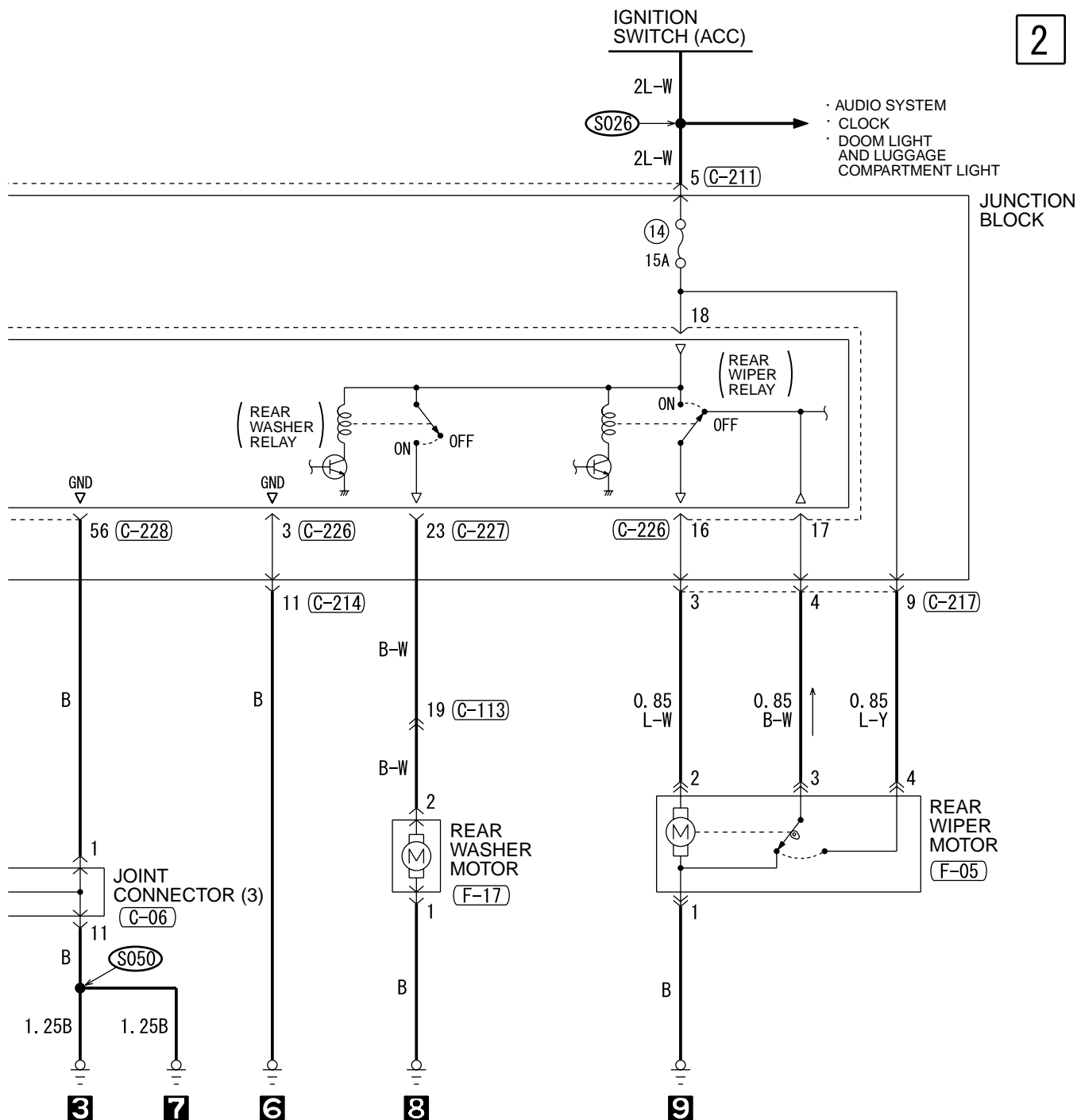

(C-101)

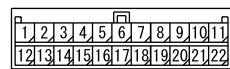

(C-113)

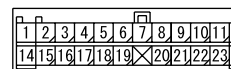

(C-129)

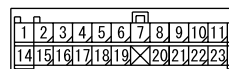

(C-206)

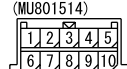

(C-206-1)

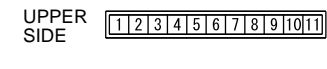

(C-226) JUNCTION BLOCK SIDE

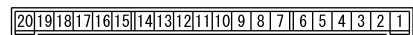

(C-227)



(C-228)

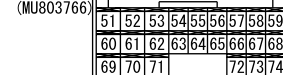

(F-05)



(F-17)



REAR WIPER AND WASHER (CONTINUED)

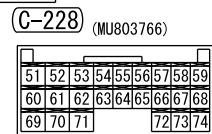
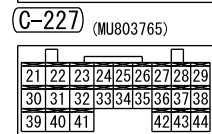
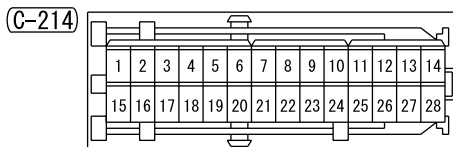
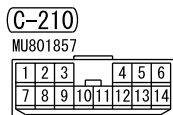
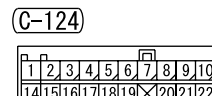
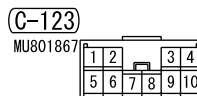
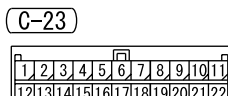
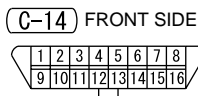
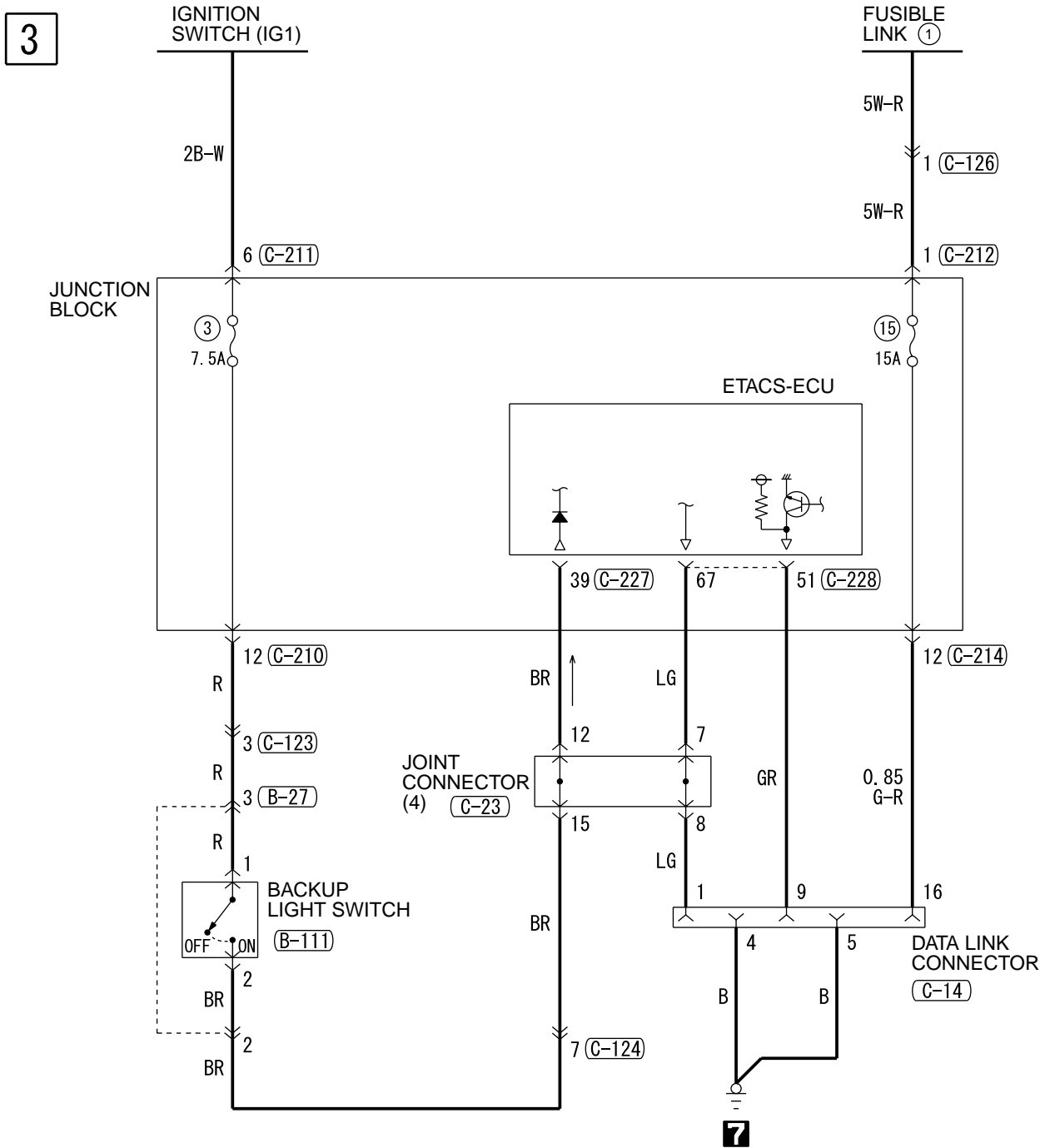

CLOCK

M1901007700291

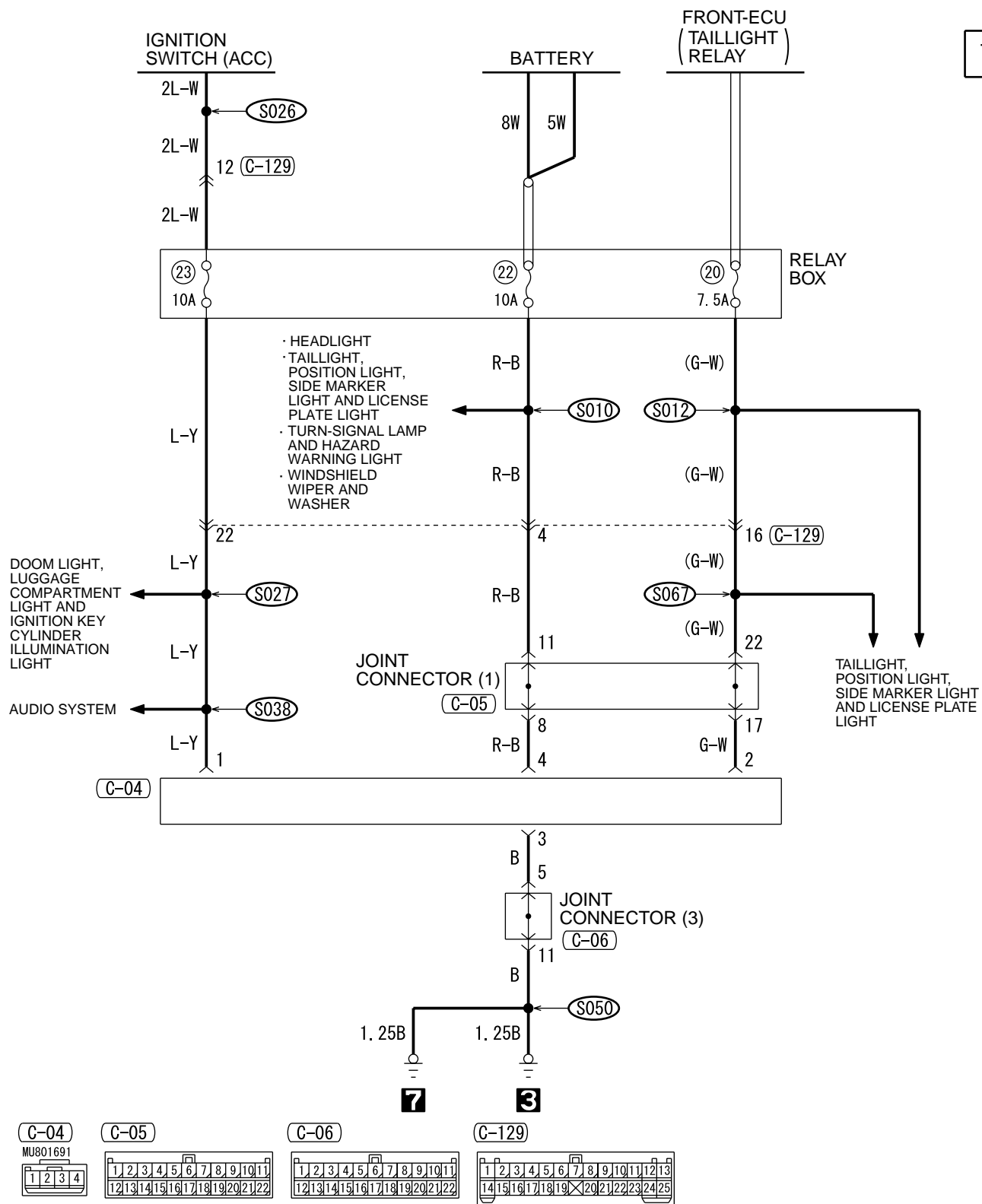

AUDIO SYSTEM

M1901015600620

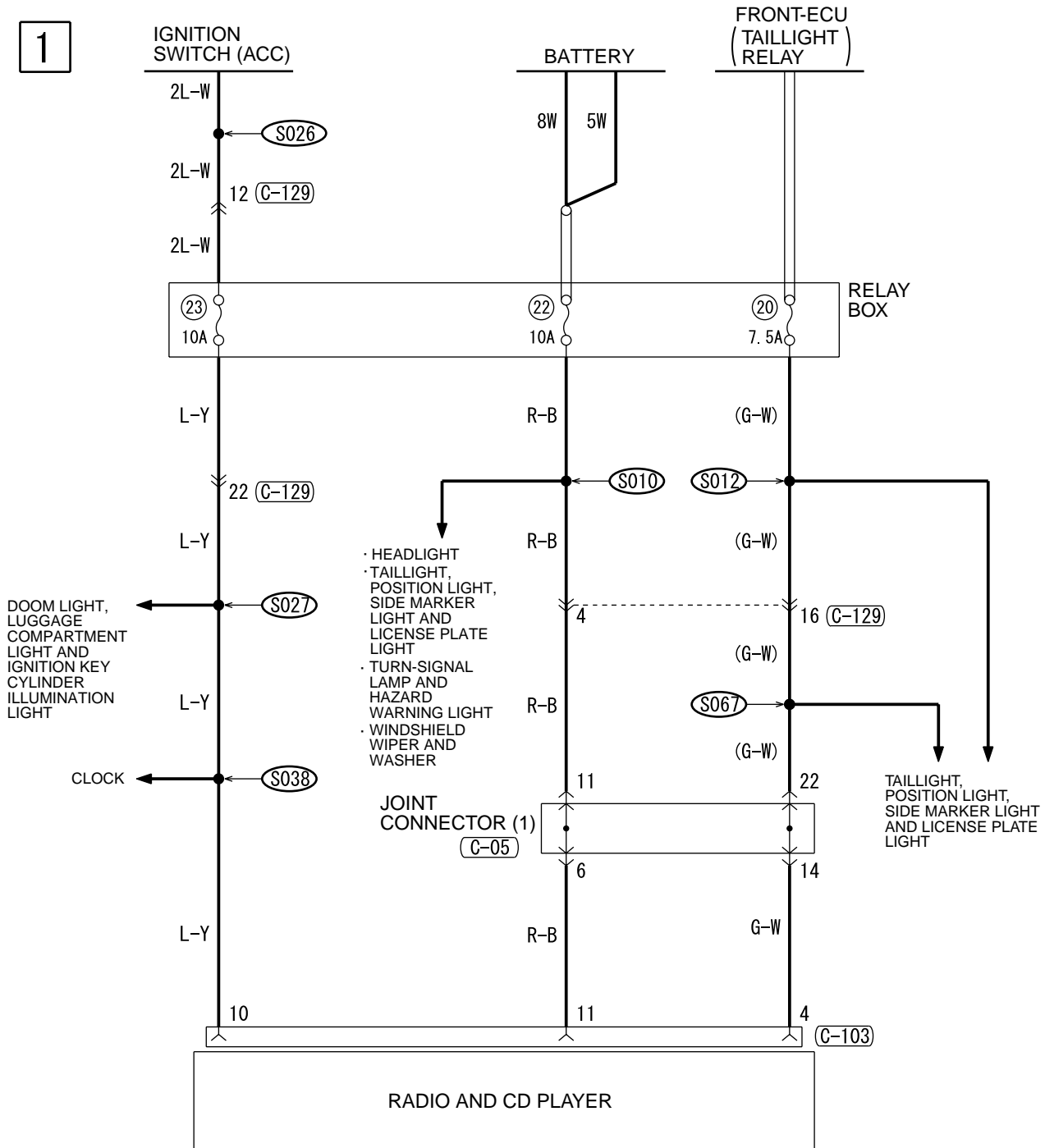

C-05

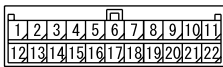

C-17

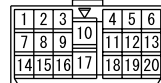

C-18



C-103

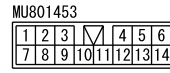

C-109



C-110

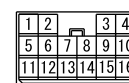

C-113

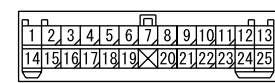

2

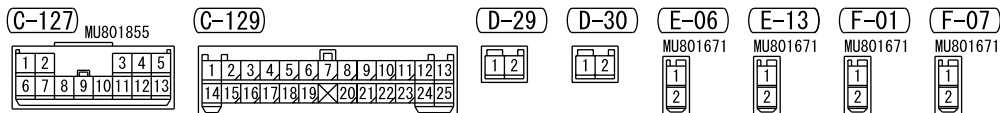
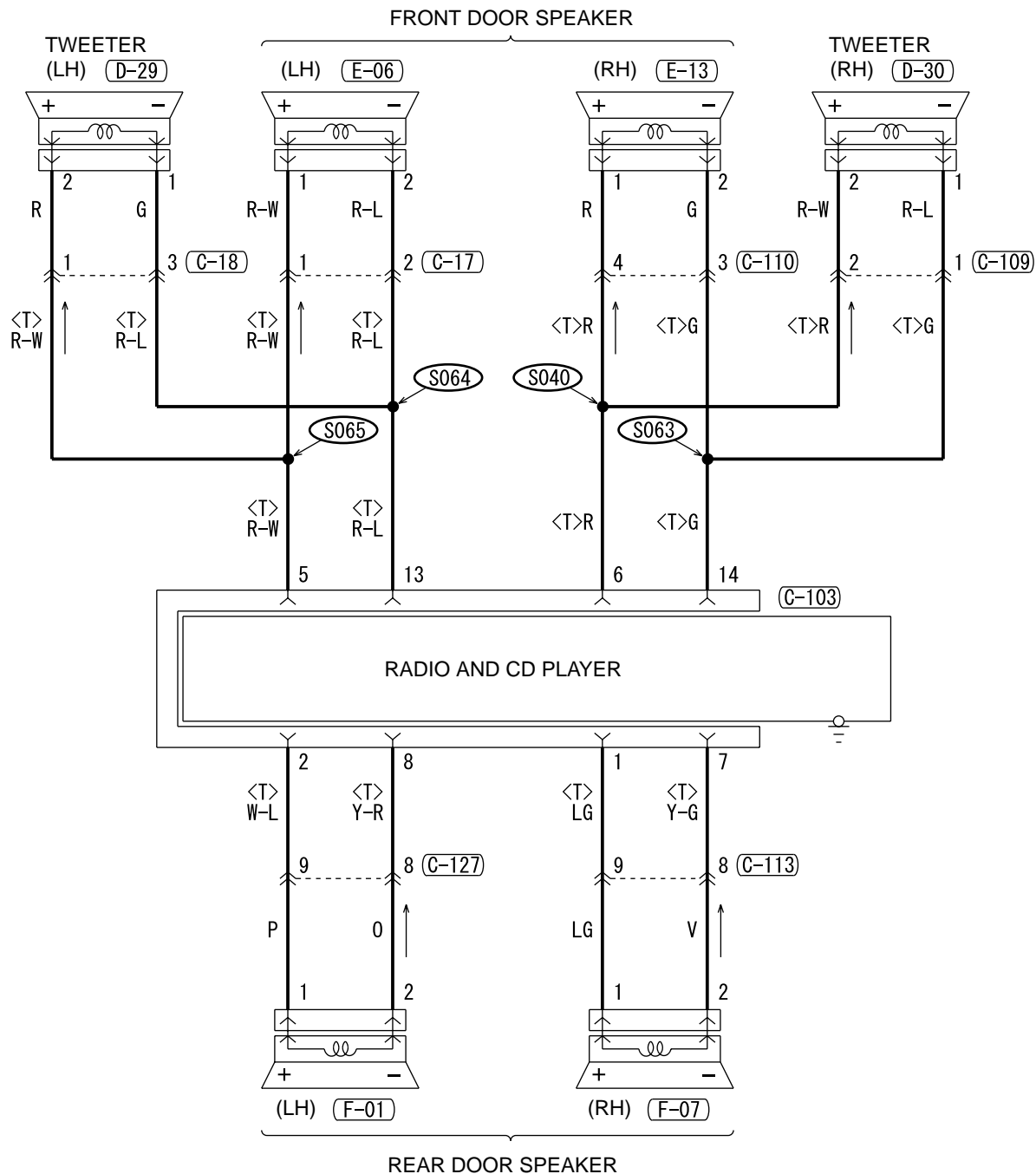

WIRE COLOR CODE
 B: BLACK LG: LIGHT GREEN G: GREEN L: BLUE W: WHITE Y: YELLOW
 SB: SKY BLUE BR: BROWN O: ORANGE GR: GRAY R: RED P: PINK V: VIOLET

H3J14M03AB

AUDIO SYSTEM (CONTINUED)

3

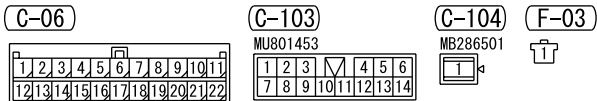
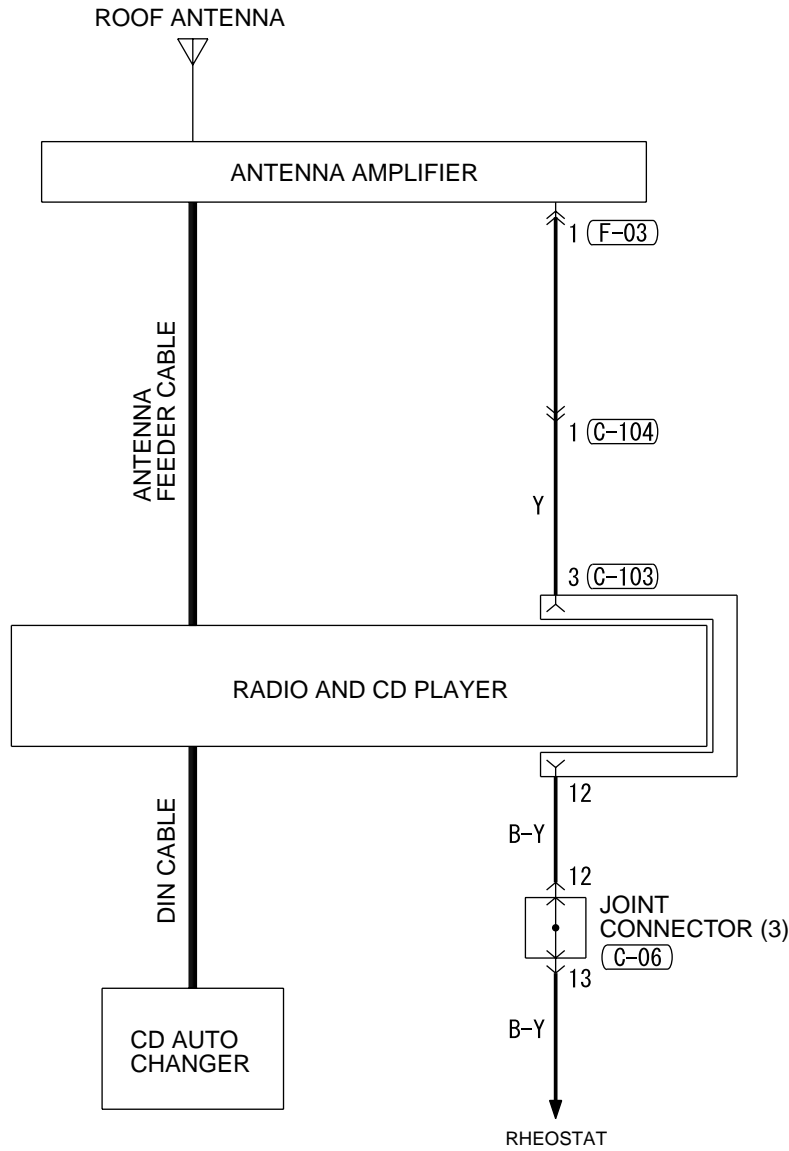

WIRE COLOR CODE

B : BLACK LG : LIGHT GREEN G : GREEN L : BLUE W : WHITE Y : YELLOW
 SB : SKY BLUE BR : BROWN O : ORANGE GR : GRAY R : RED P : PINK V : VIOLET

H3J14M03BA

CIGARETTE LIGHTER

1

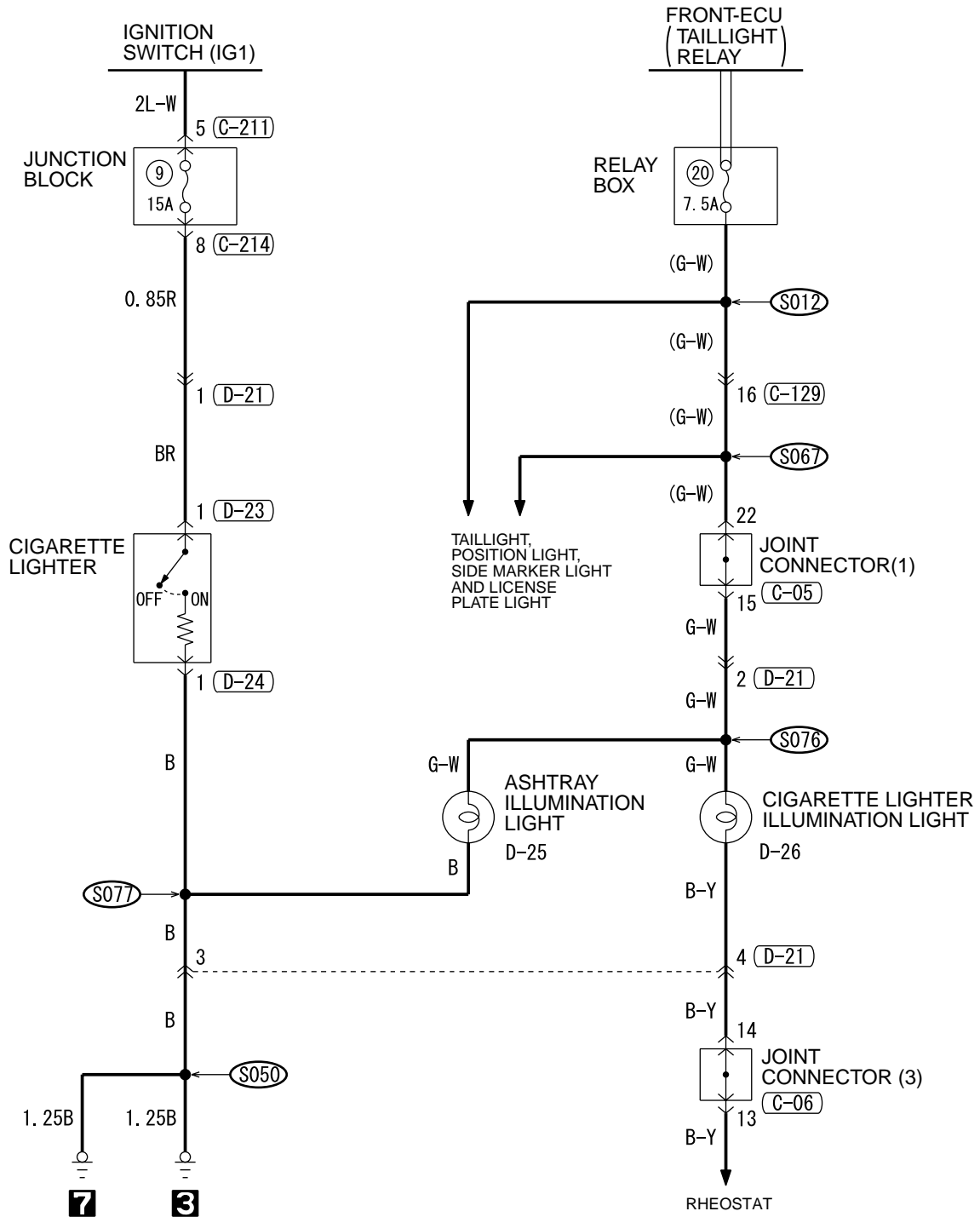

C-05

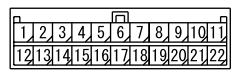

C-06

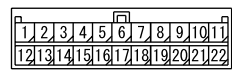

C-129

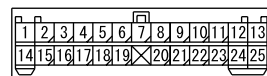

C-211



C-214

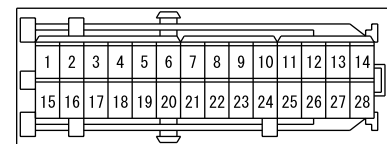

D-21

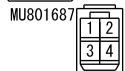

D-23



D-24



ANTI-LOCK BRAKING SYSTEM(ABS)

M1901008400754

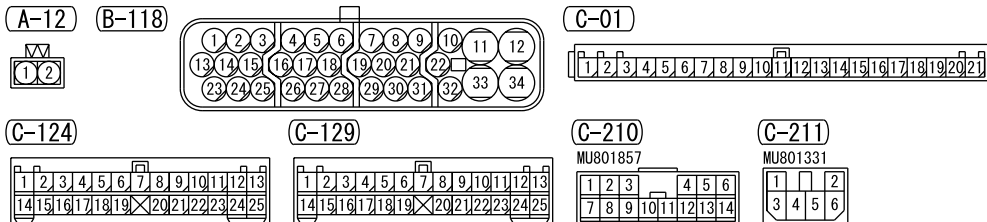
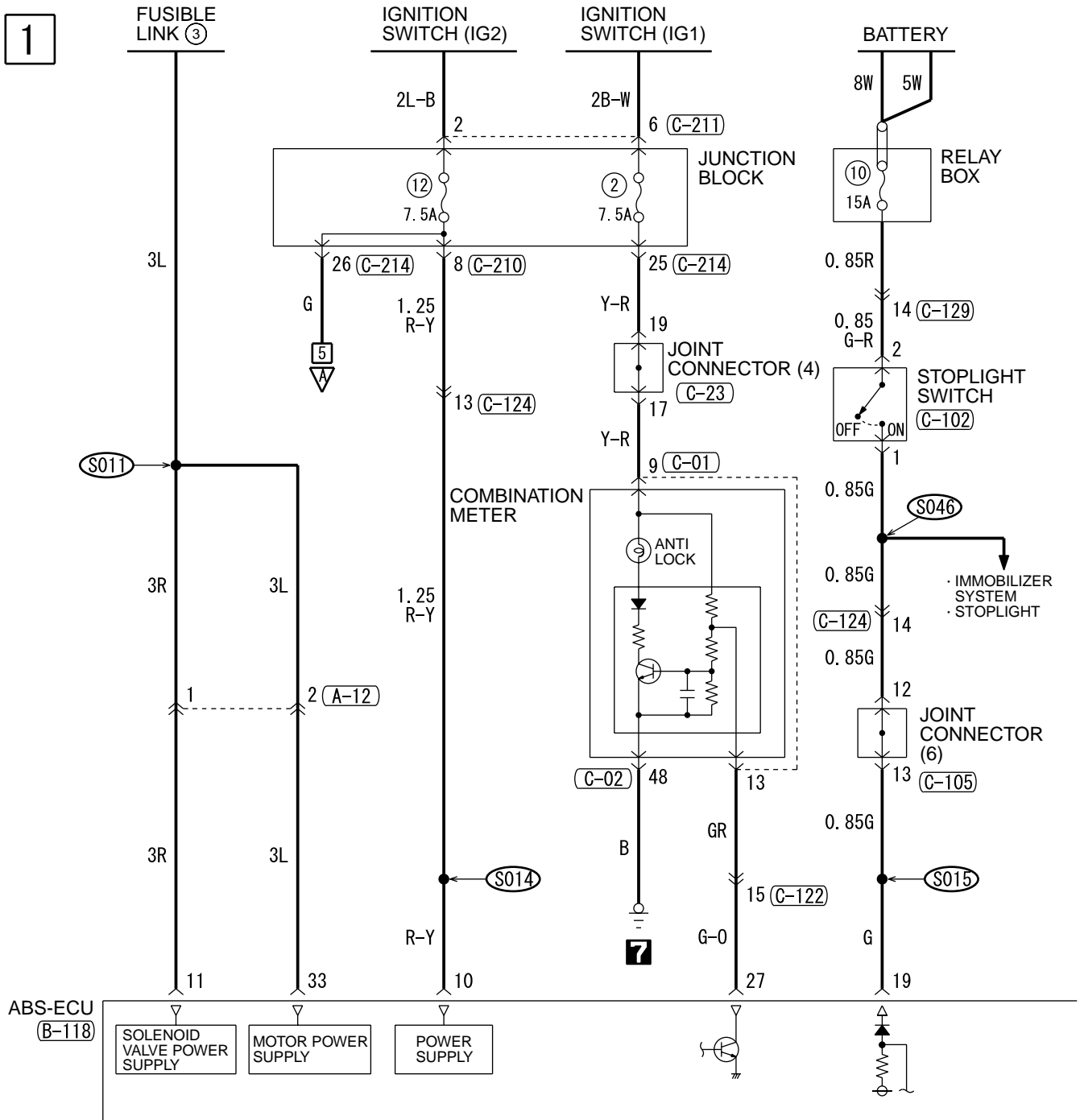

H3J15M10AA

HYDRAULIC UNIT

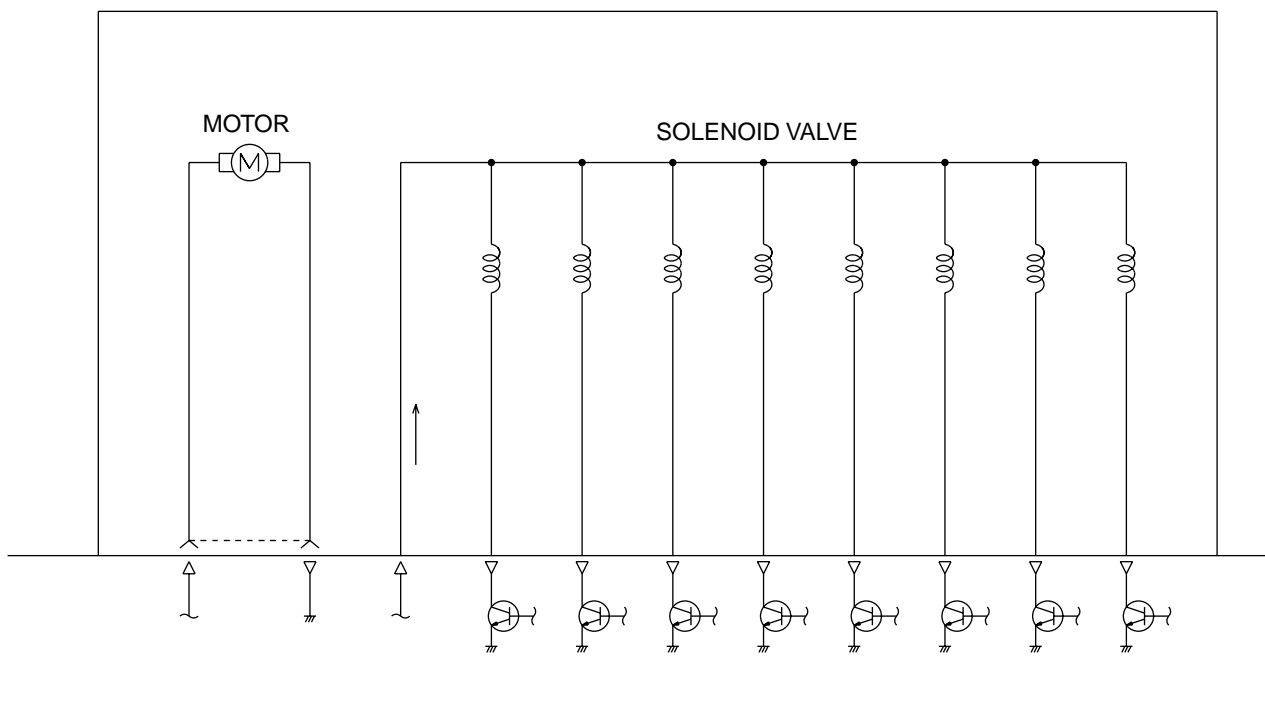

C-02

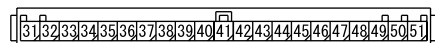

C-23

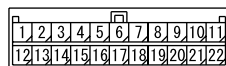

C-102



C-105



C-122

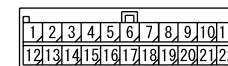

C-214

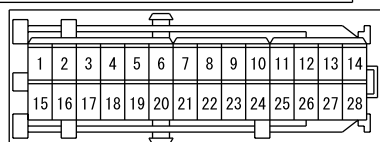

WIRE COLOR CODE
 B : BLACK LG : LIGHT GREEN G : GREEN L : BLUE
 BR : BROWN O : ORANGE GR : GRAY R : RED W : WHITE
 SB : SKY BLUE P : PINK Y : YELLOW V : VIOLET

H3J15M10AB

ANTI-LOCK BRAKING SYSTEM(ABS) (CONTINUED)

3

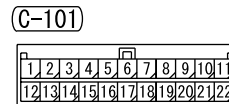
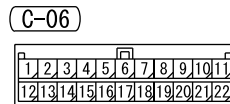
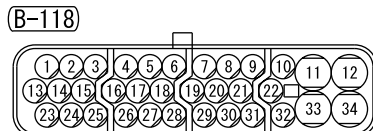
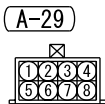
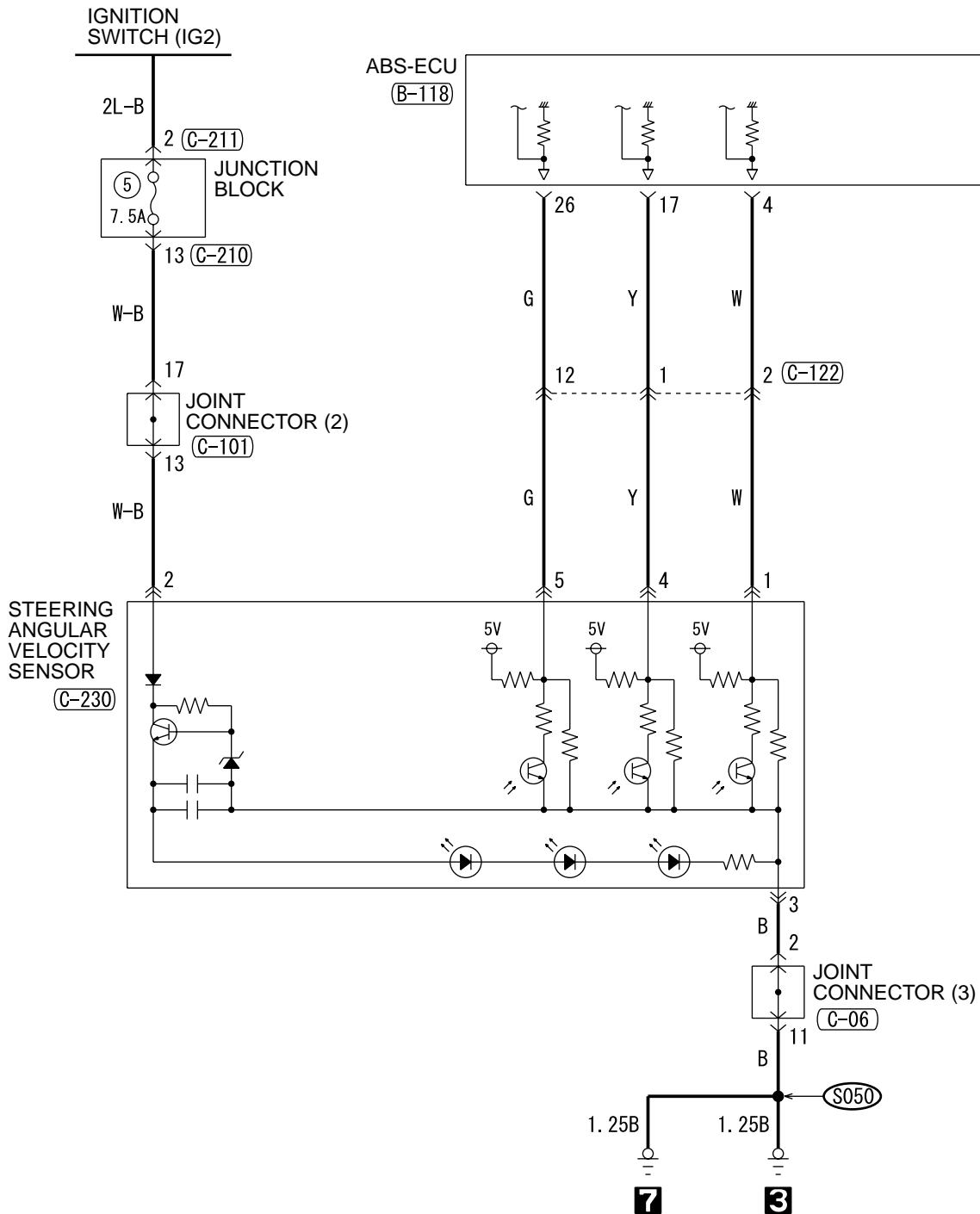

4

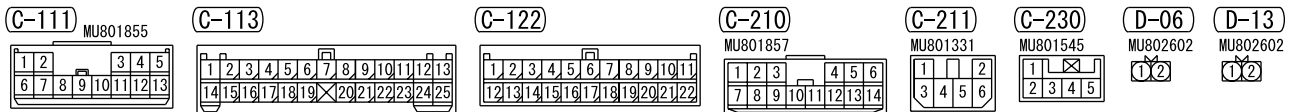
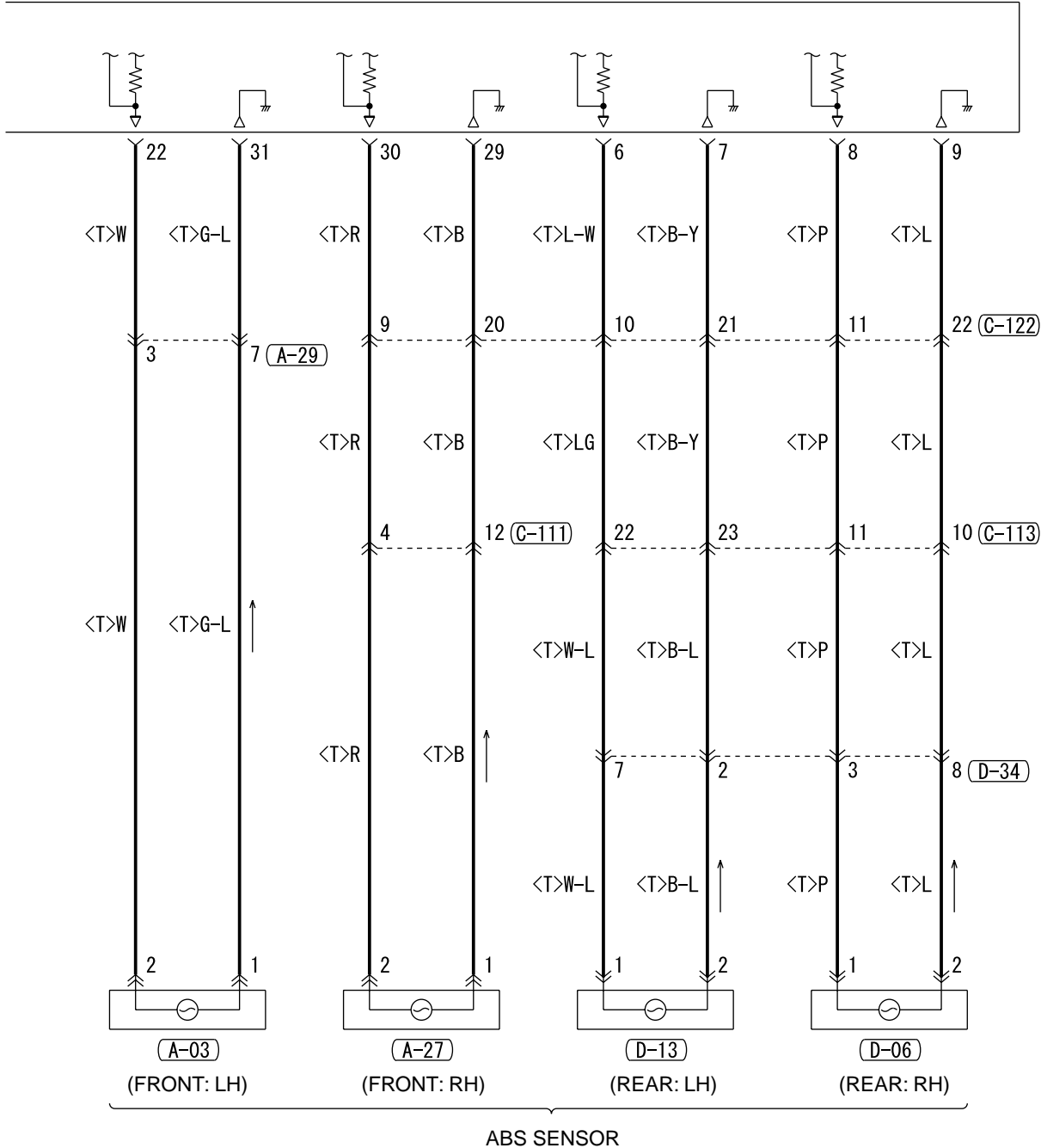

WIRE COLOR CODE
 B : BLACK LG : LIGHT GREEN G : GREEN L : BLUE W : WHITE Y : YELLOW
 SB : SKY BLUE BR : BROWN O : ORANGE GR : GRAY R : RED P : PINK V : VIOLET

H3J15M10BB

ANTI-LOCK BRAKING SYSTEM(ABS) (CONTINUED)

5

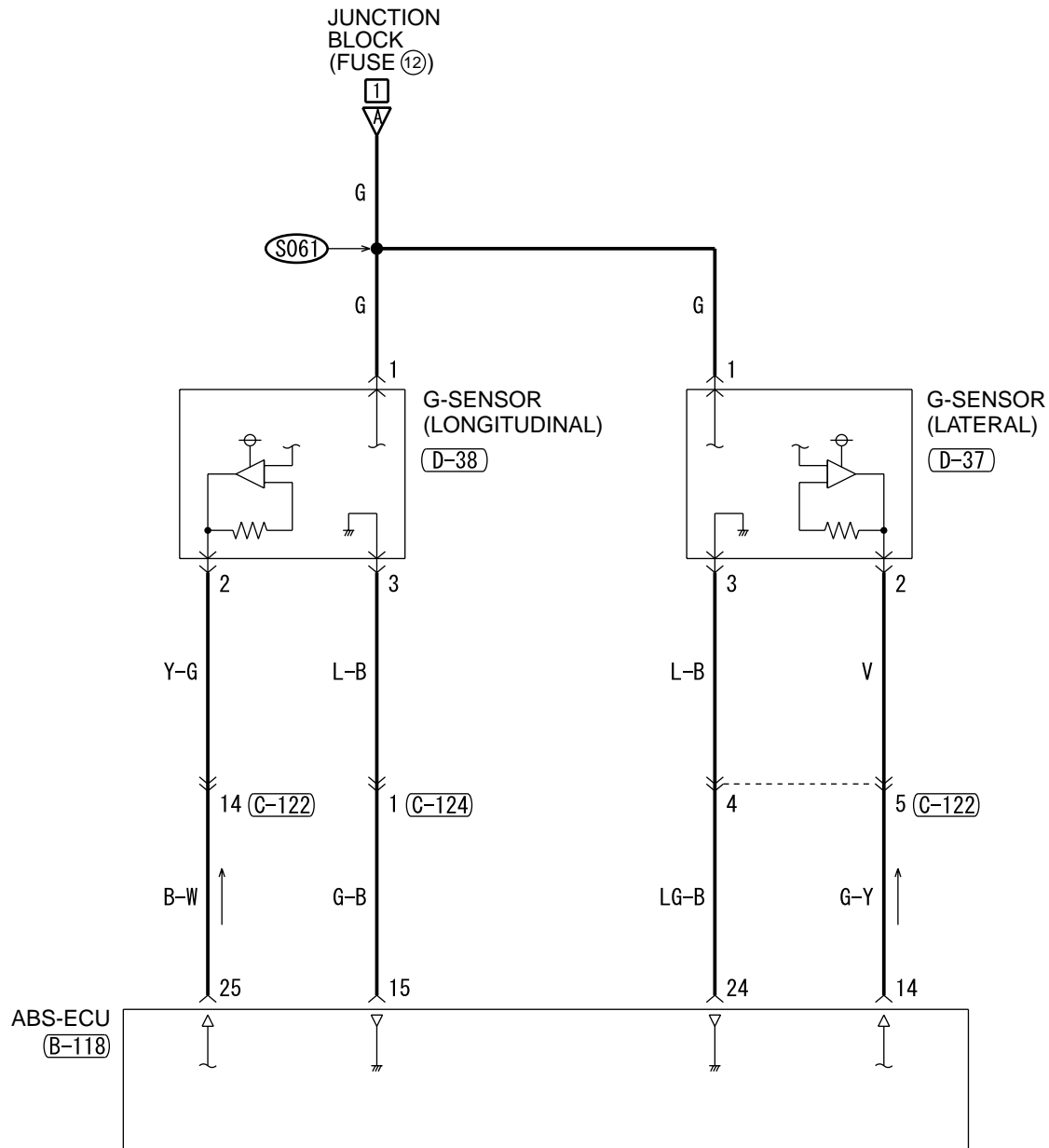

B-118

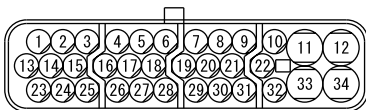

C-124

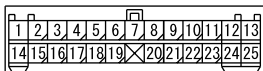

C-126



C-212



C-214

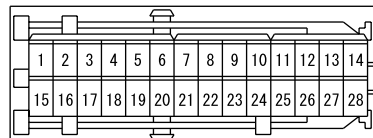

C-14 FRONT SIDE

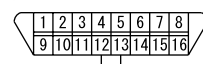

D-28



D-37



D-38



H3J15M10CA

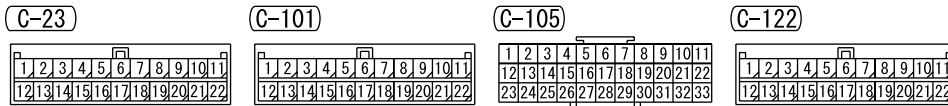
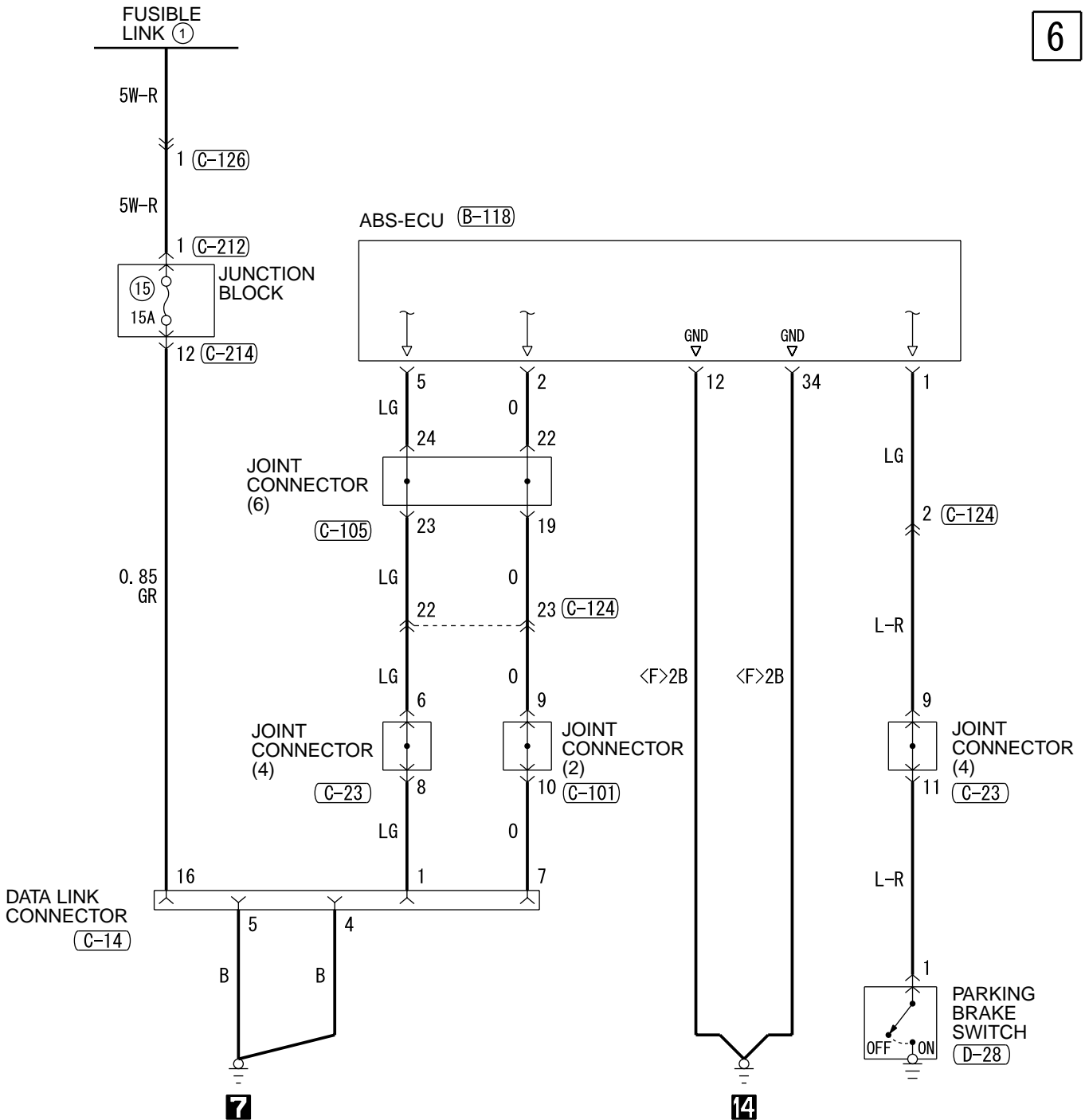

WIRE COLOR CODE
 B : BLACK LG : LIGHT GREEN G : GREEN L : BLUE W : WHITE Y : YELLOW
 SB : SKY BLUE BR : BROWN O : ORANGE GR : GRAY R : RED P : PINK V : VIOLET

SUPPLEMENTAL RESTRAINT SYSTEM(SRS)

M1901009700747

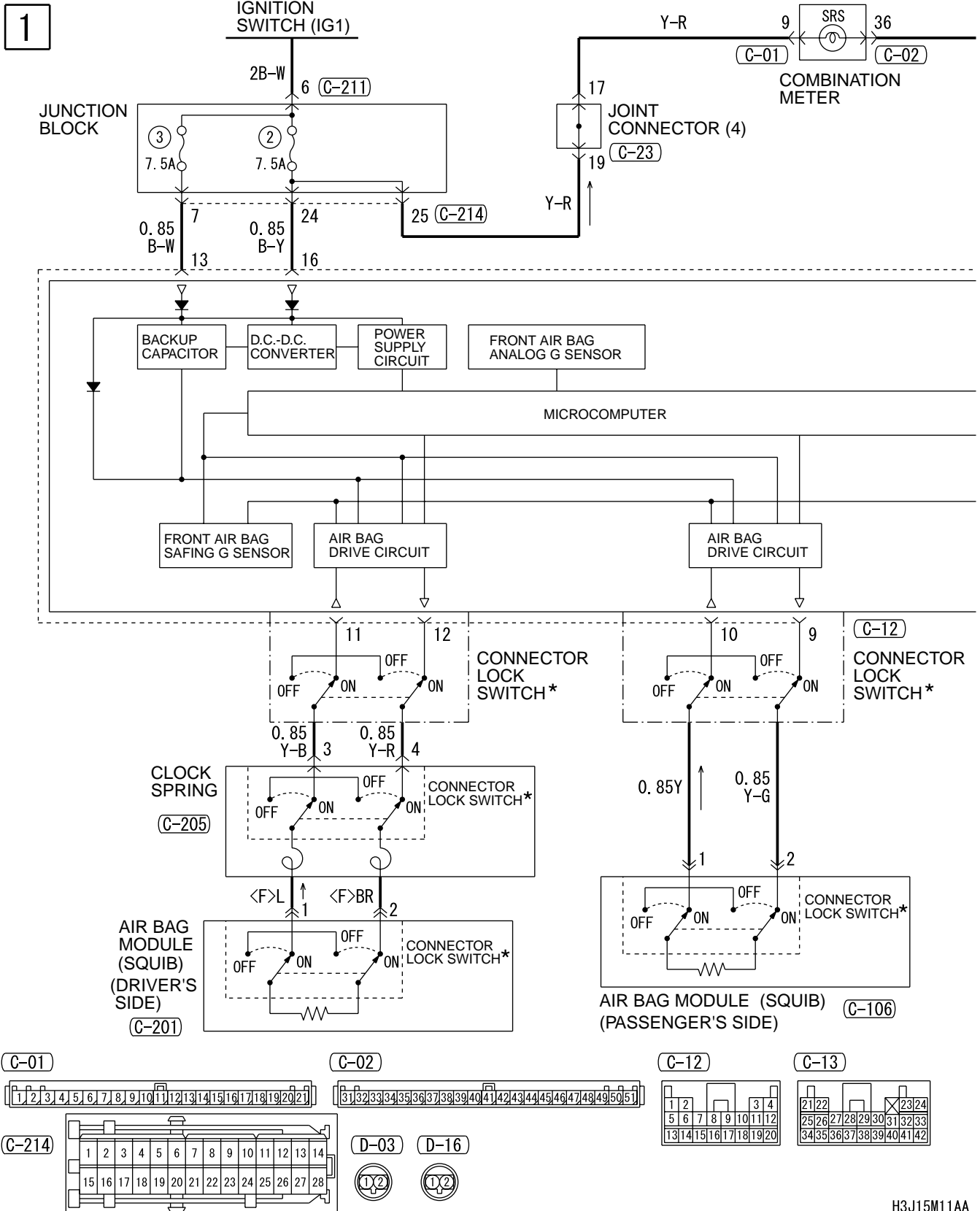

2

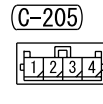
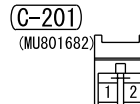
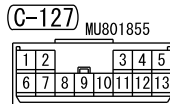
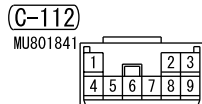
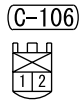
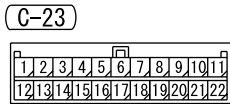
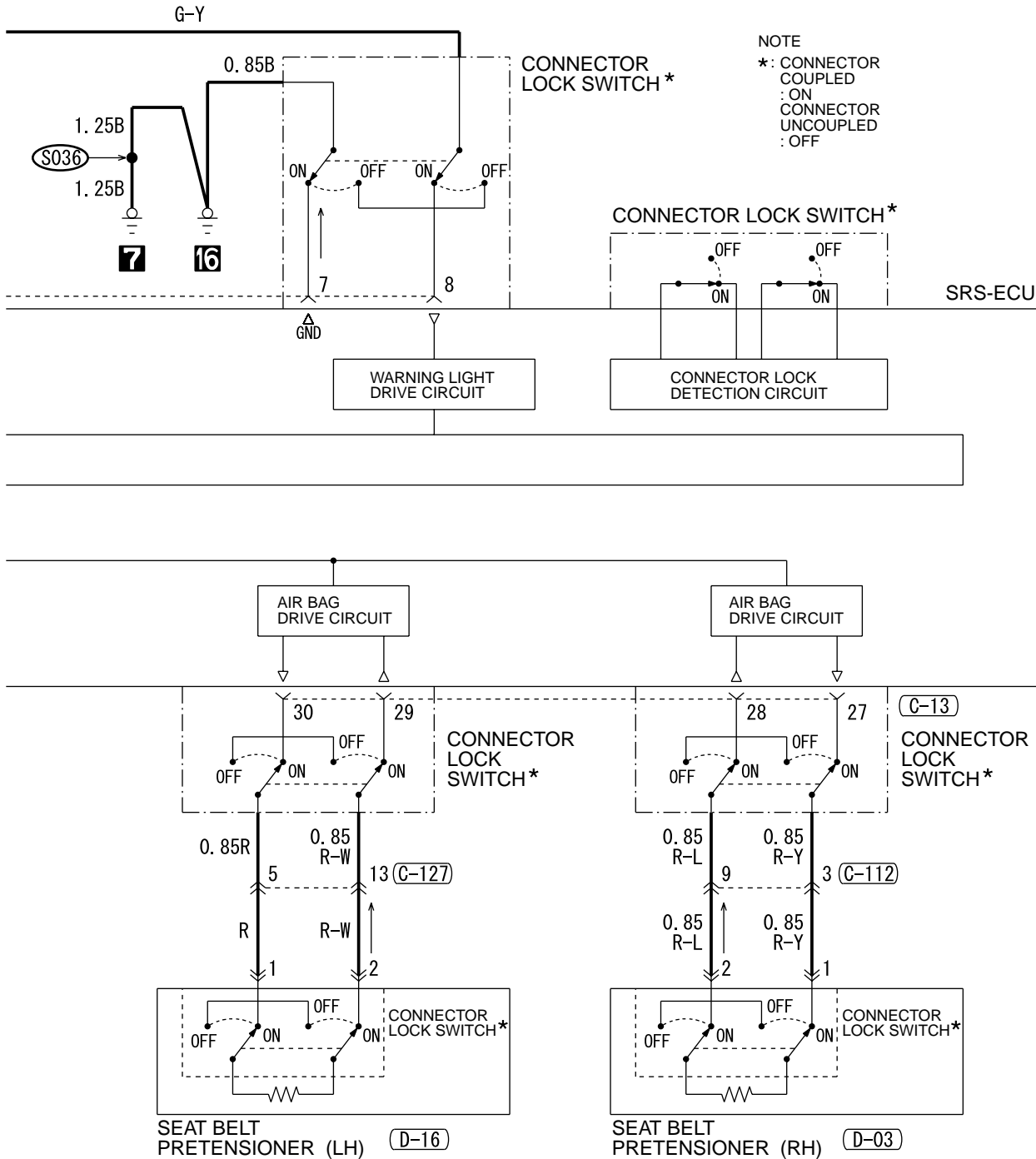

WIRE COLOR CODE

B : BLACK LG : LIGHT GREEN G : GREEN L : BLUE W : WHITE Y : YELLOW
SB : SKY BLUE BR : BROWN O : ORANGE GR : GRAY R : RED P : PINK V : VIOLET

SUPPLEMENTAL RESTRAINT SYSTEM (SRS) (CONTINUED)

3

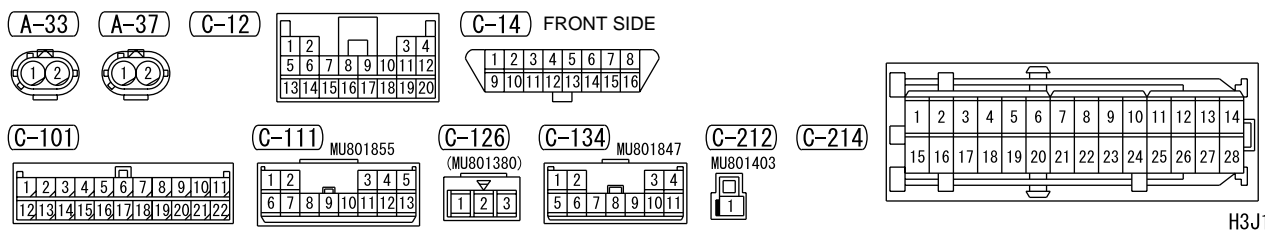
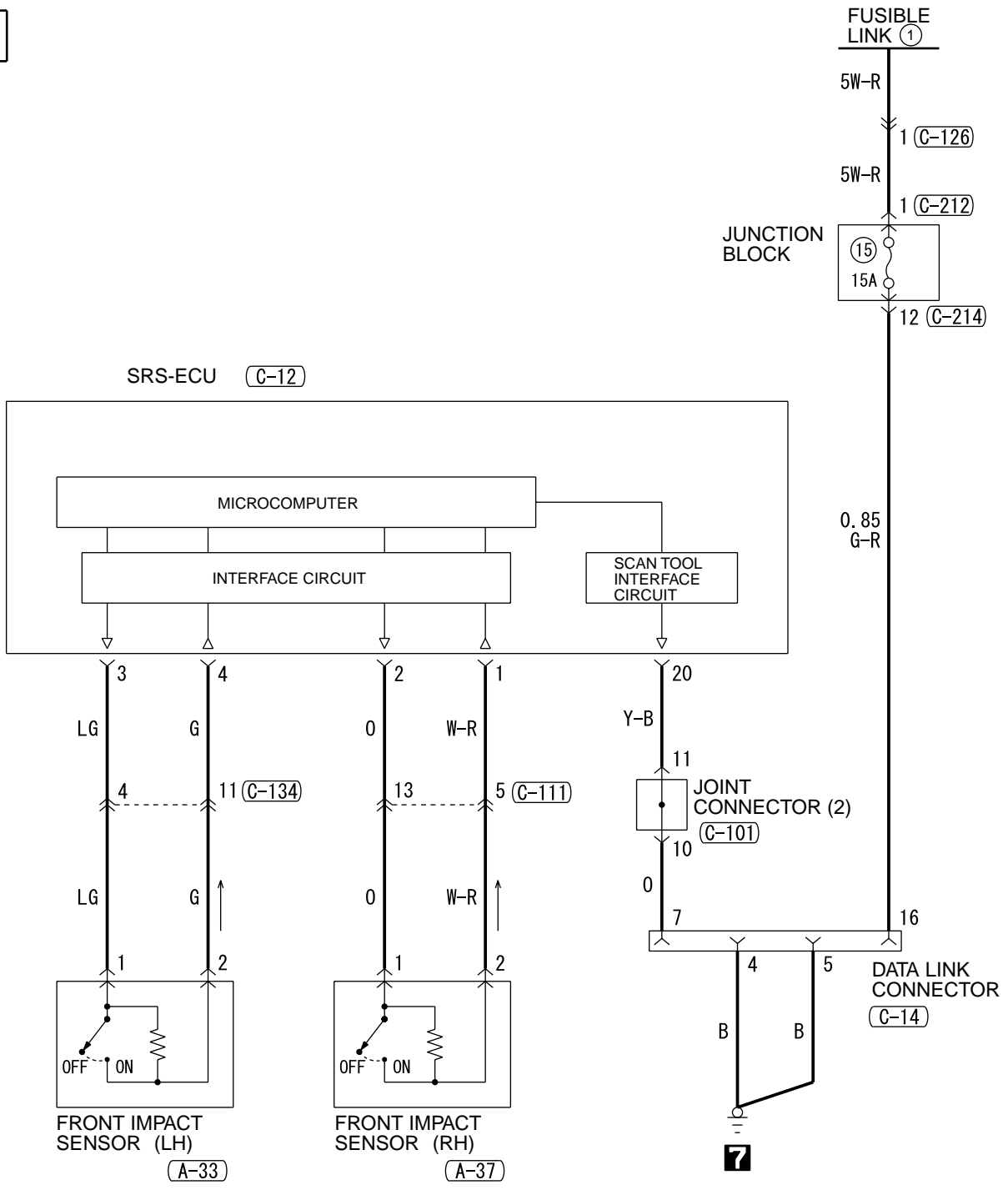

H3J15M11BA

NOTES

CHARGE AIR COOLER WATER SPLAY SYSTEM

M1901017400019

1

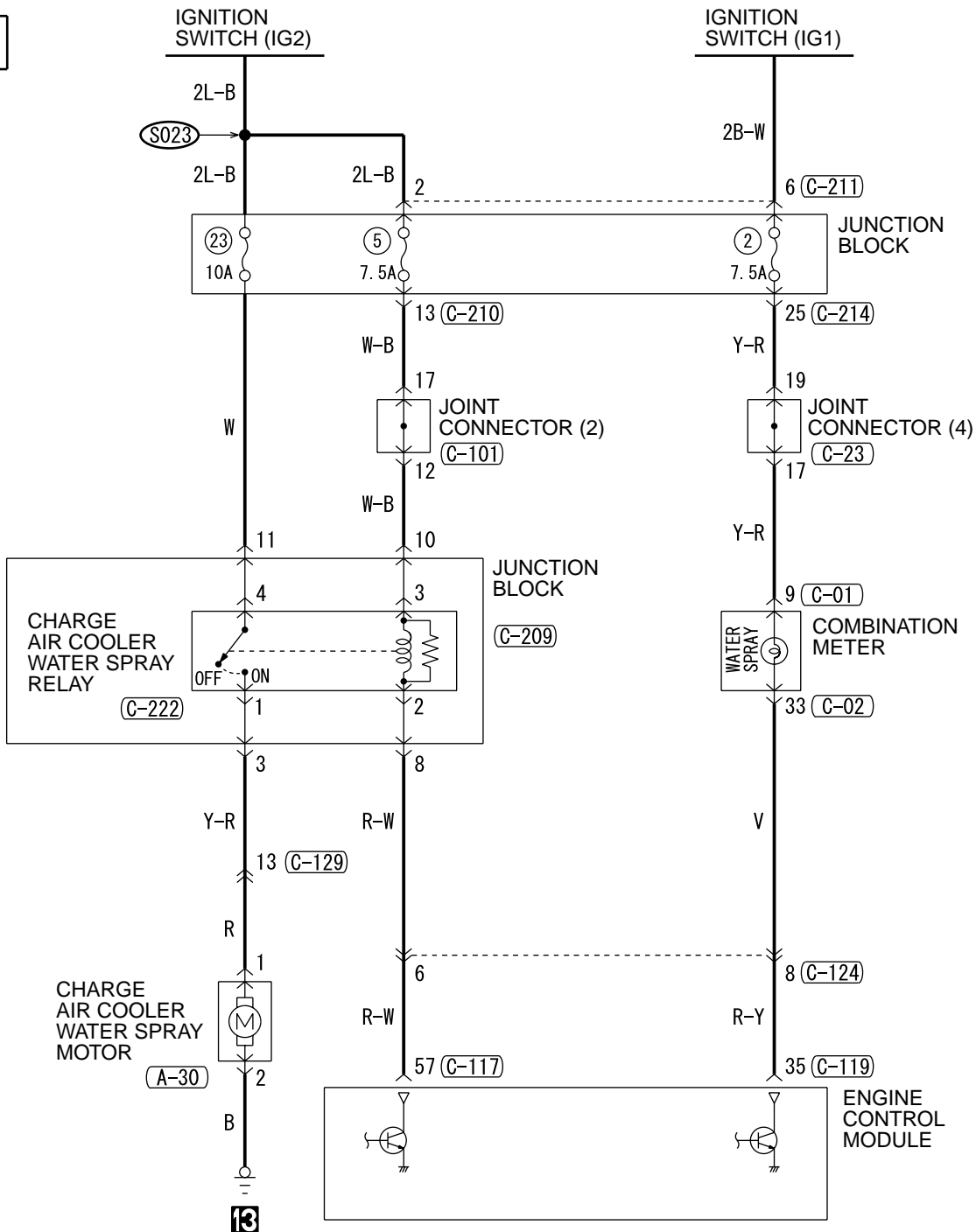

(A-30) (C-01)

(12)

1	2	3	4	5	6	7	8	9	10	11	12	13	14	15	16	17	18	19	20	21
---	---	---	---	---	---	---	---	---	----	----	----	----	----	----	----	----	----	----	----	----

(C-02)

31	32	33	34	35	36	37	38	39	40	41	42	43	44	45	46	47	48	49	50	51
----	----	----	----	----	----	----	----	----	----	----	----	----	----	----	----	----	----	----	----	----

(C-05)

1	2	3	4	5	6	7	8	9	10	11
12	13	14	15	16	17	18	19	20	21	22

(C-115) (MU801823)

71	72	73	74	75	76	77	78	79	80	81
82	83	84	85	86	87	88	89	90	91	92

(C-117) (MU801820)

51	52	53	54	55	56
57	58	59	60	61	62

(C-119) (MU801822)

31	32	33	34	35	36	37	38
39	40	41	42	43	44	45	46

(C-124)

1	2	3	4	5	6	7	8	9	10	11	12	13
14	15	16	17	18	19	20	21	22	23	24	25	

(C-129)

1	2	3	4	5	6	7	8	9	10	11	12	13
14	15	16	17	18	19	20	21	22	23	24	25	

H3J15M12AA

TSB Revision

2

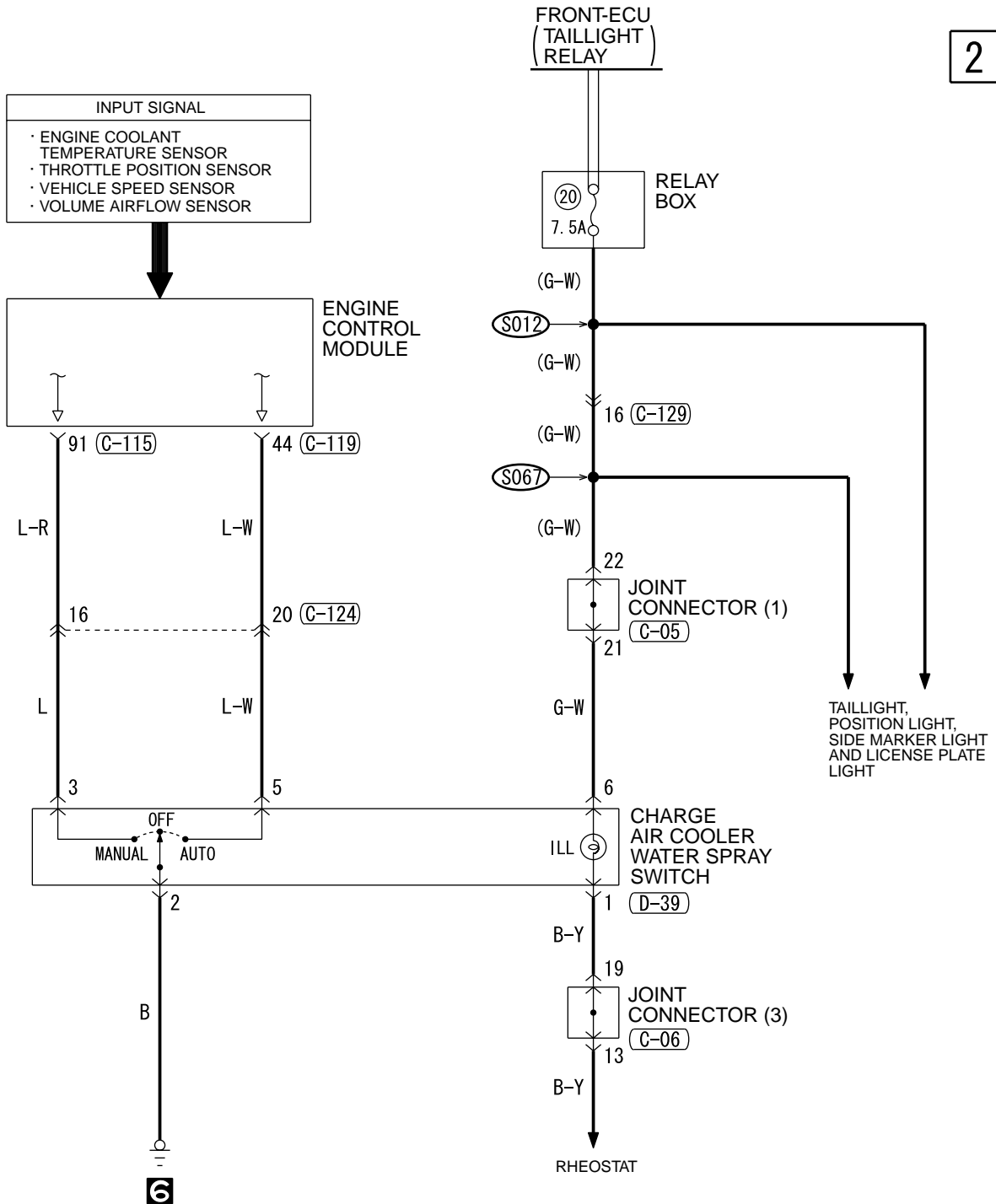

(C-06)

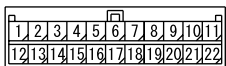

(C-23)

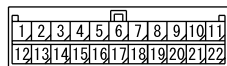

(C-101)

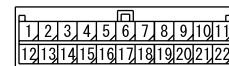

(C-209) MU801855

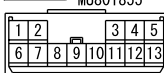

(C-210) MU801857

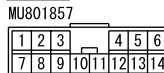

(C-211) MU801331



(C-214)

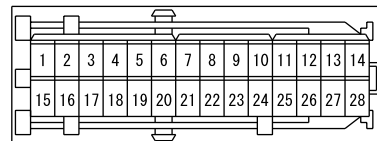

(C-222)



(D-39) MU801447



TSB Revision

IMMOBILIZER SYSTEM

M1901013600798

1

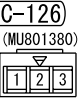
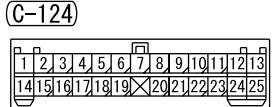
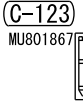
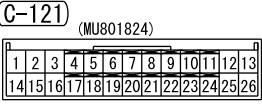
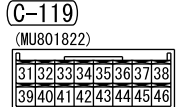
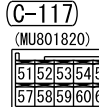
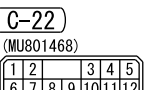
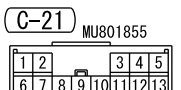
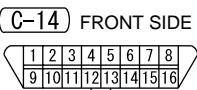
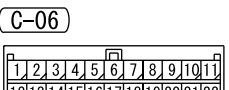
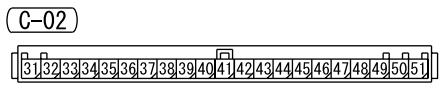
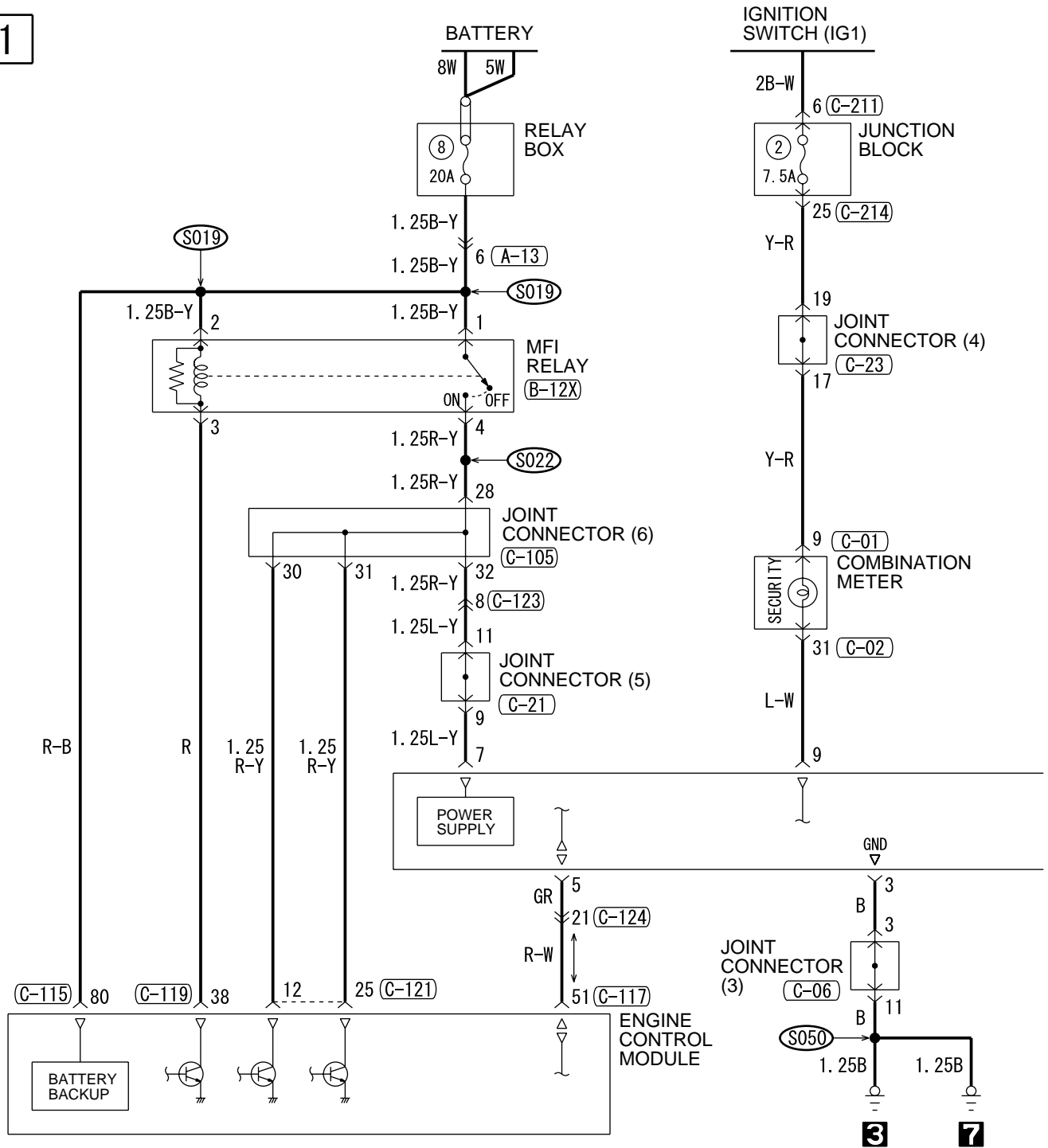

H3J15M13AA

2

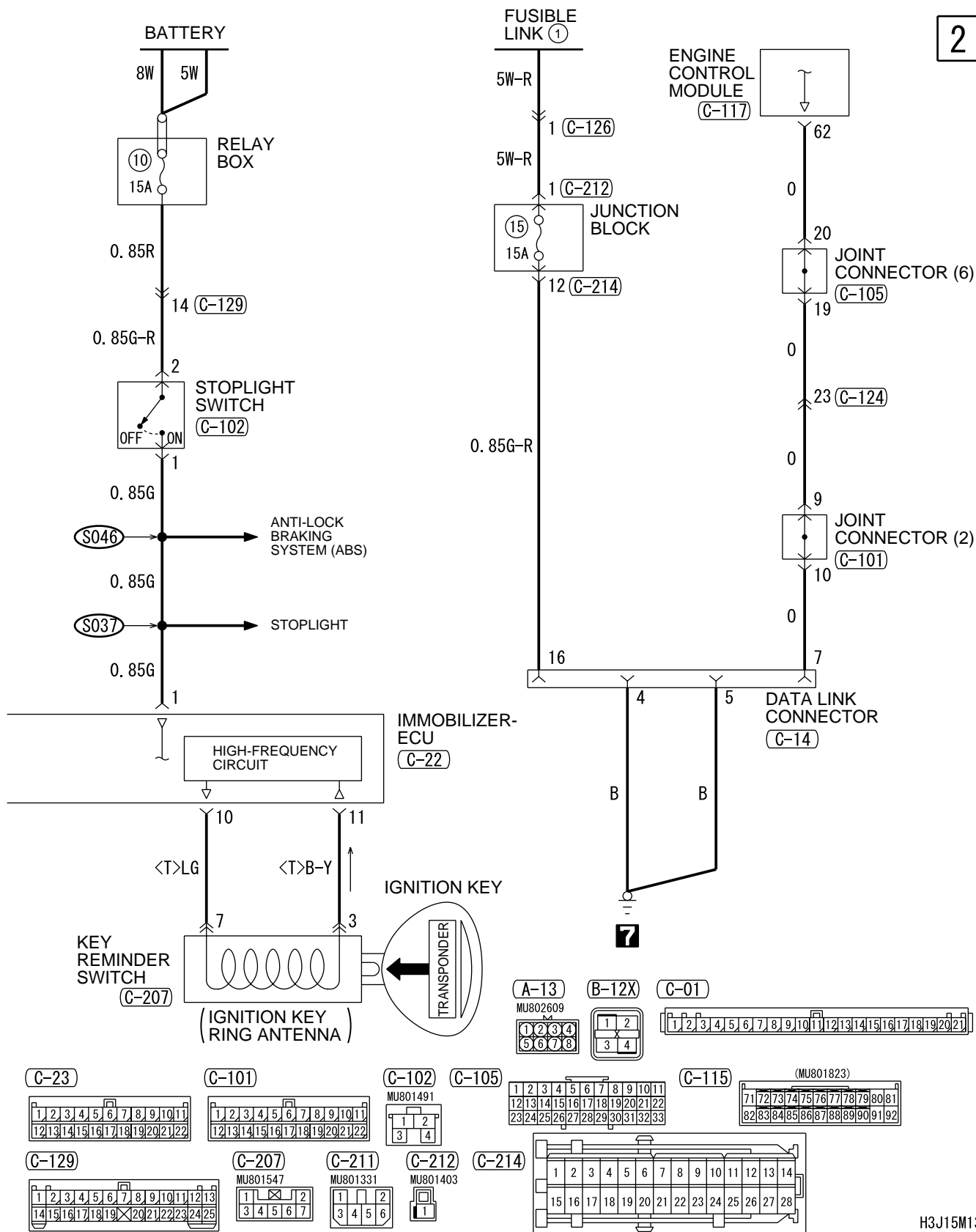

LIGHTING MONITOR TONE ALARM

M1901011400389

1

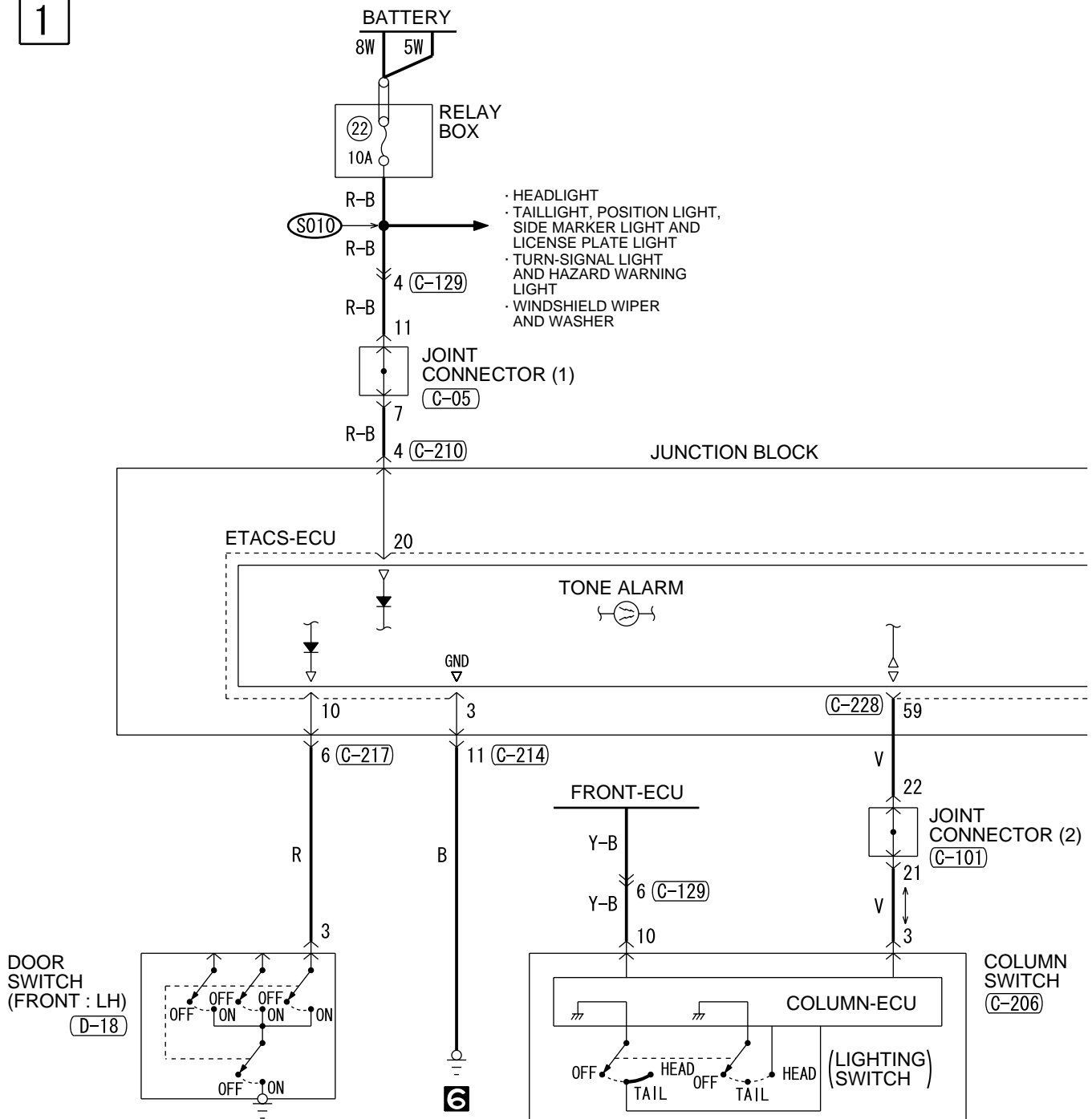

- HEADLIGHT
- TAILLIGHT, POSITION LIGHT, SIDE MARKER LIGHT AND LICENSE PLATE LIGHT
- TURN-SIGNAL LIGHT AND HAZARD WARNING LIGHT
- WINDSHIELD WIPER AND WASHER

(C-05)

1	2	3	4	5	6	7	8	9	10	11
12	13	14	15	16	17	18	19	20	21	22

(C-06)

1	2	3	4	5	6	7	8	9	10	11
12	13	14	15	16	17	18	19	20	21	22

(C-14) FRONT SIDE

1	2	3	4	5	6	7	8
9	10	11	12	13	14	15	16

(C-23)

1	2	3	4	5	6	7	8	9	10	11
12	13	14	15	16	17	18	19	20	21	22

(C-101)

1	2	3	4	5	6	7	8	9	10	11
12	13	14	15	16	17	18	19	20	21	22

(C-217)

1	2	3	4	5	6	7	
8	9	10	11	12	13	14	15

(C-226) JUNCTION BLOCK SIDE

20	19	18	17	16	15	14	13	12	11	10	9	8	7	6	5	4	3	2	1
----	----	----	----	----	----	----	----	----	----	----	---	---	---	---	---	---	---	---	---

(C-228)

(MU803766)

51	52	53	54	55	56	57	58	59
60	61	62	63	64	65	66	67	68
69	70	71	72	73	74			

(D-18)

(MU801536)

1	2	3
---	---	---

H3J15M14AA

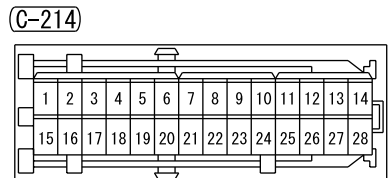
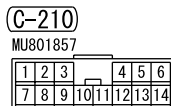
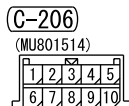
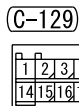
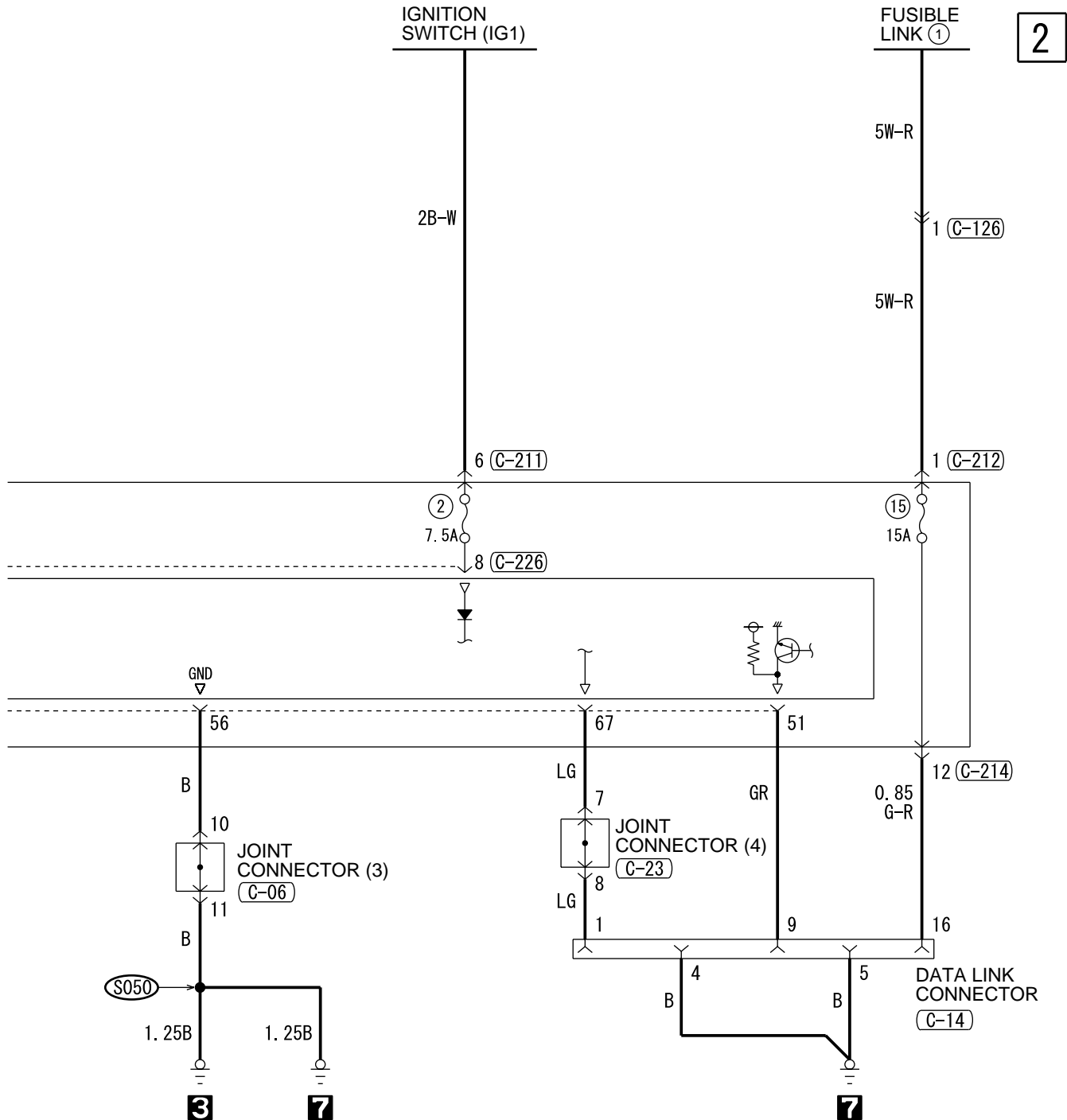

WIRE COLOR CODE
 B : BLACK LG : LIGHT GREEN G : GREEN L : BLUE
 BR : BROWN O : ORANGE GR : GRAY R : RED W : WHITE
 SB : SKY BLUE P : PINK Y : YELLOW V : VIOLET

SEAT BELT WARNING LIGHT

M1901015700047

1

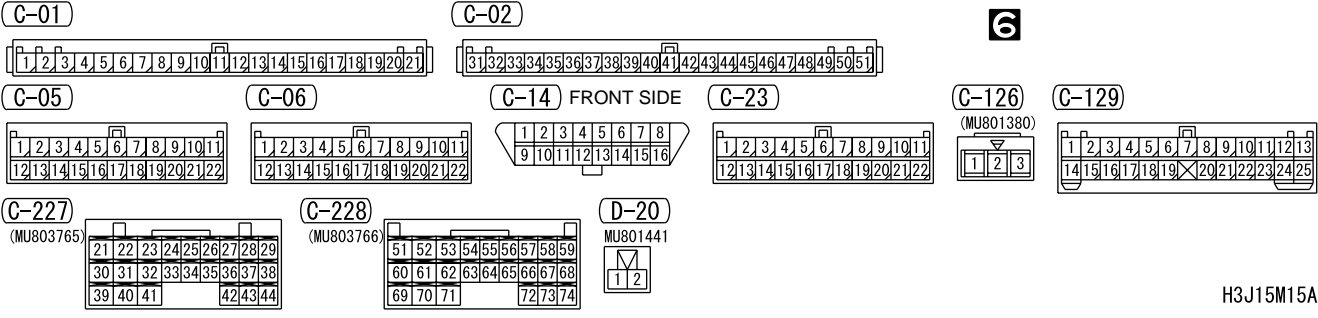
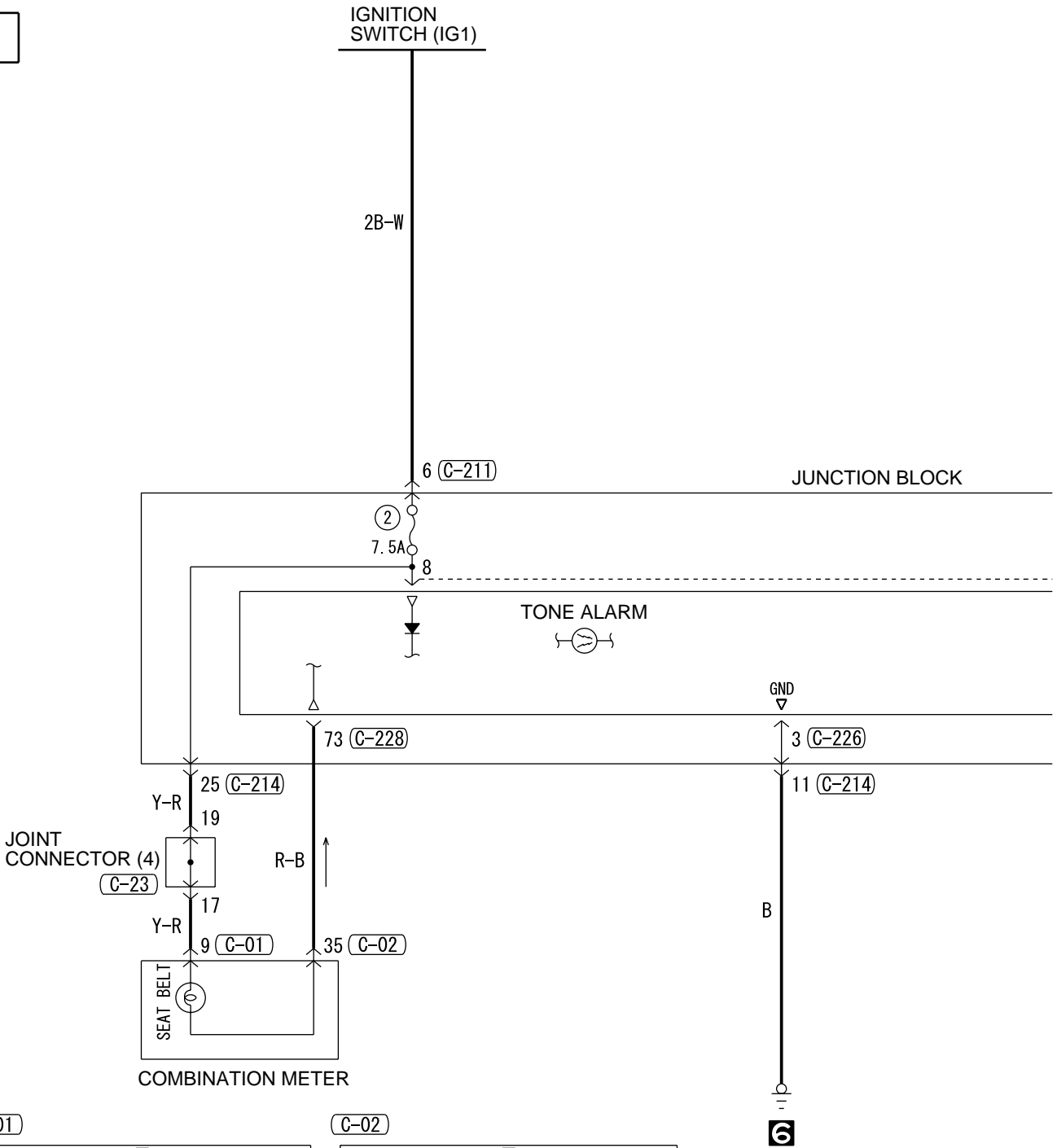

H3J15M15AA

TSB Revision

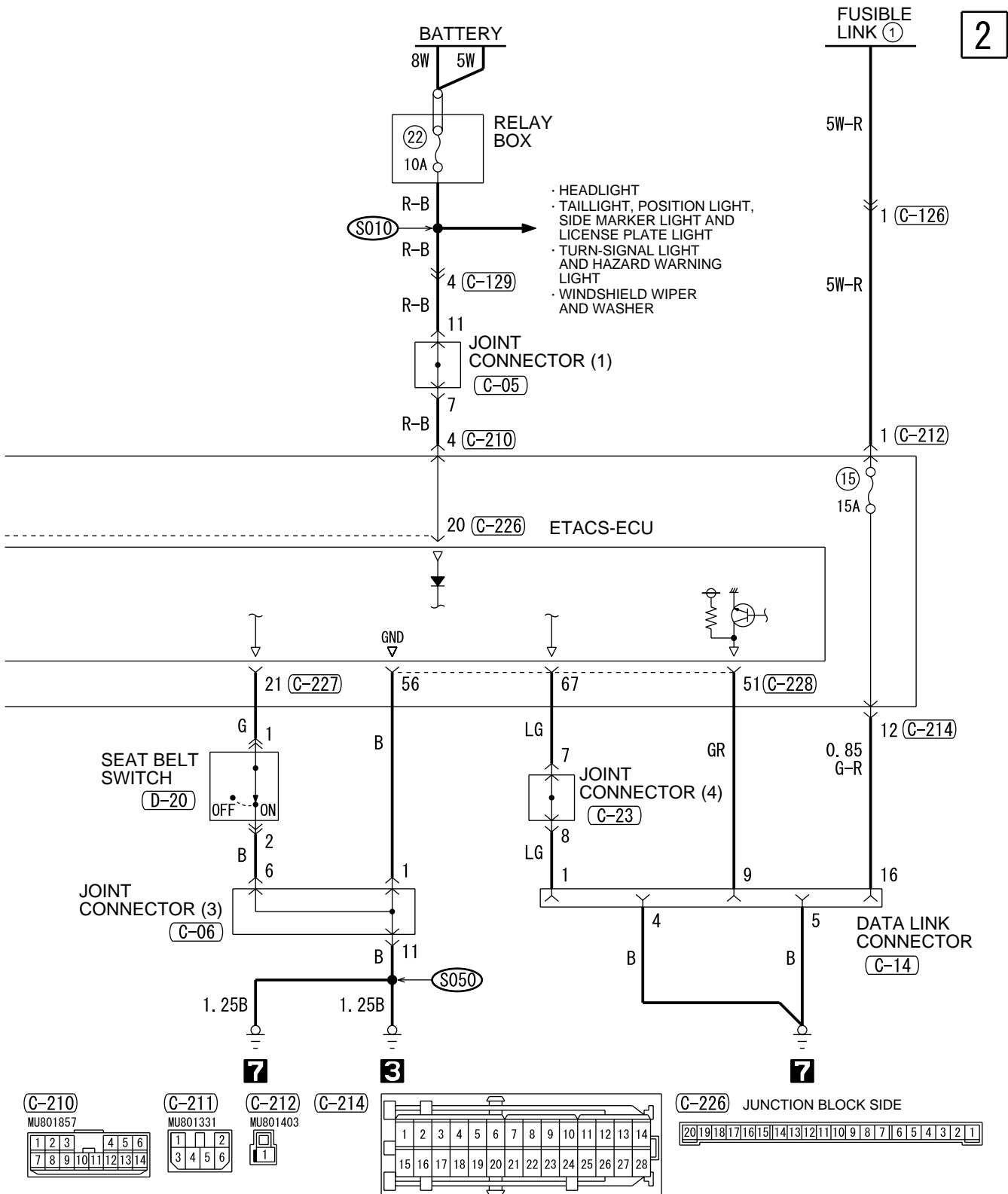

IGNITION KEY REMINDER TONE ALARM

M1901011300401

1

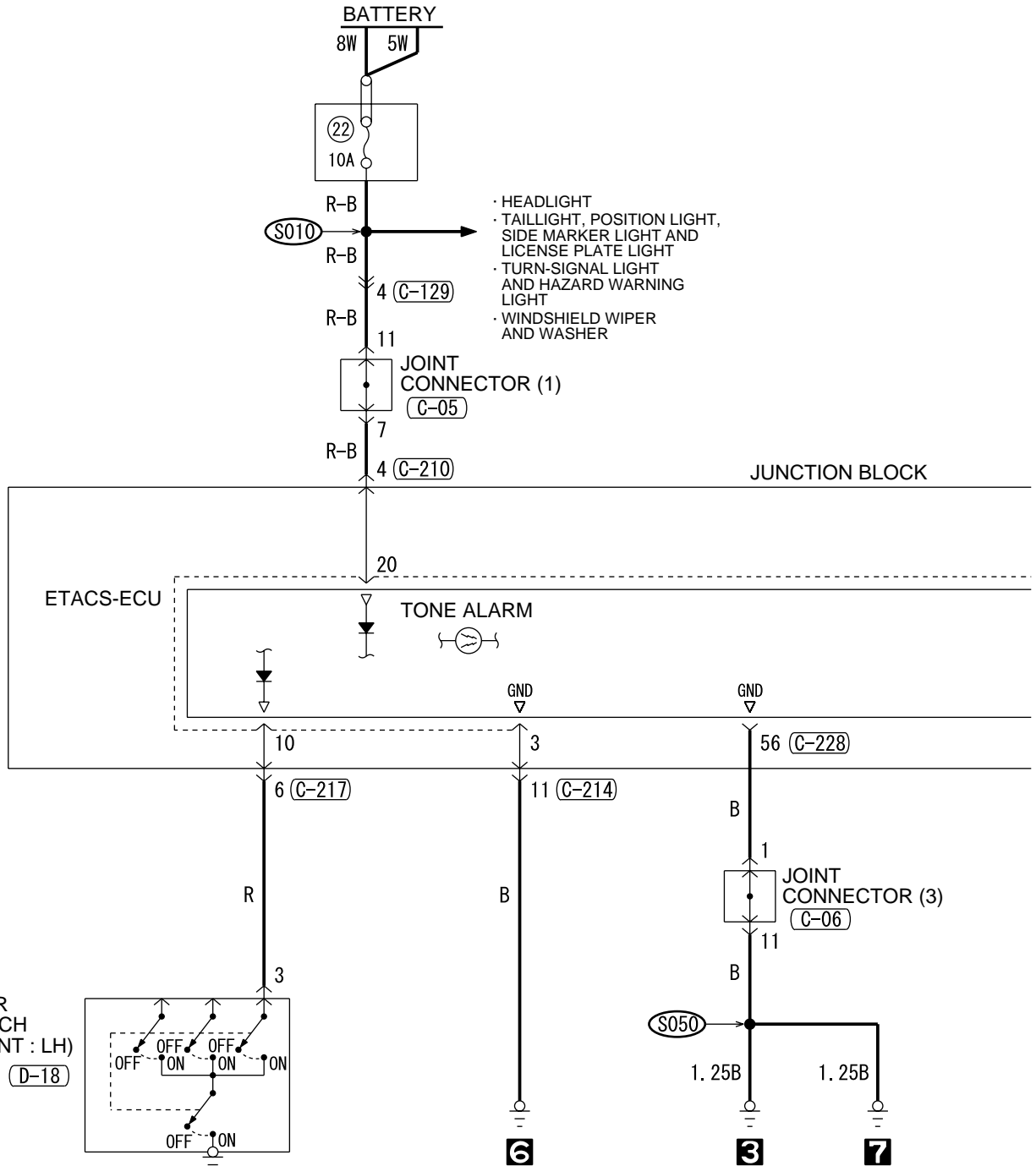

- HEADLIGHT
- TAILLIGHT, POSITION LIGHT, SIDE MARKER LIGHT AND LICENSE PLATE LIGHT
- TURN-SIGNAL LIGHT AND HAZARD WARNING LIGHT
- WINDSHIELD WIPER AND WASHER

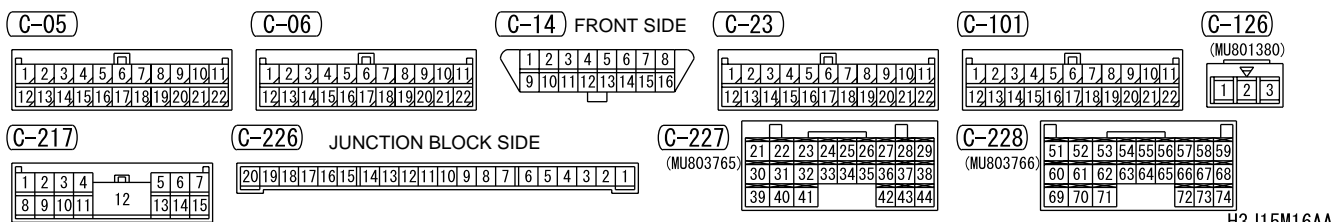

H3J15M16AA

TSB Revision

2

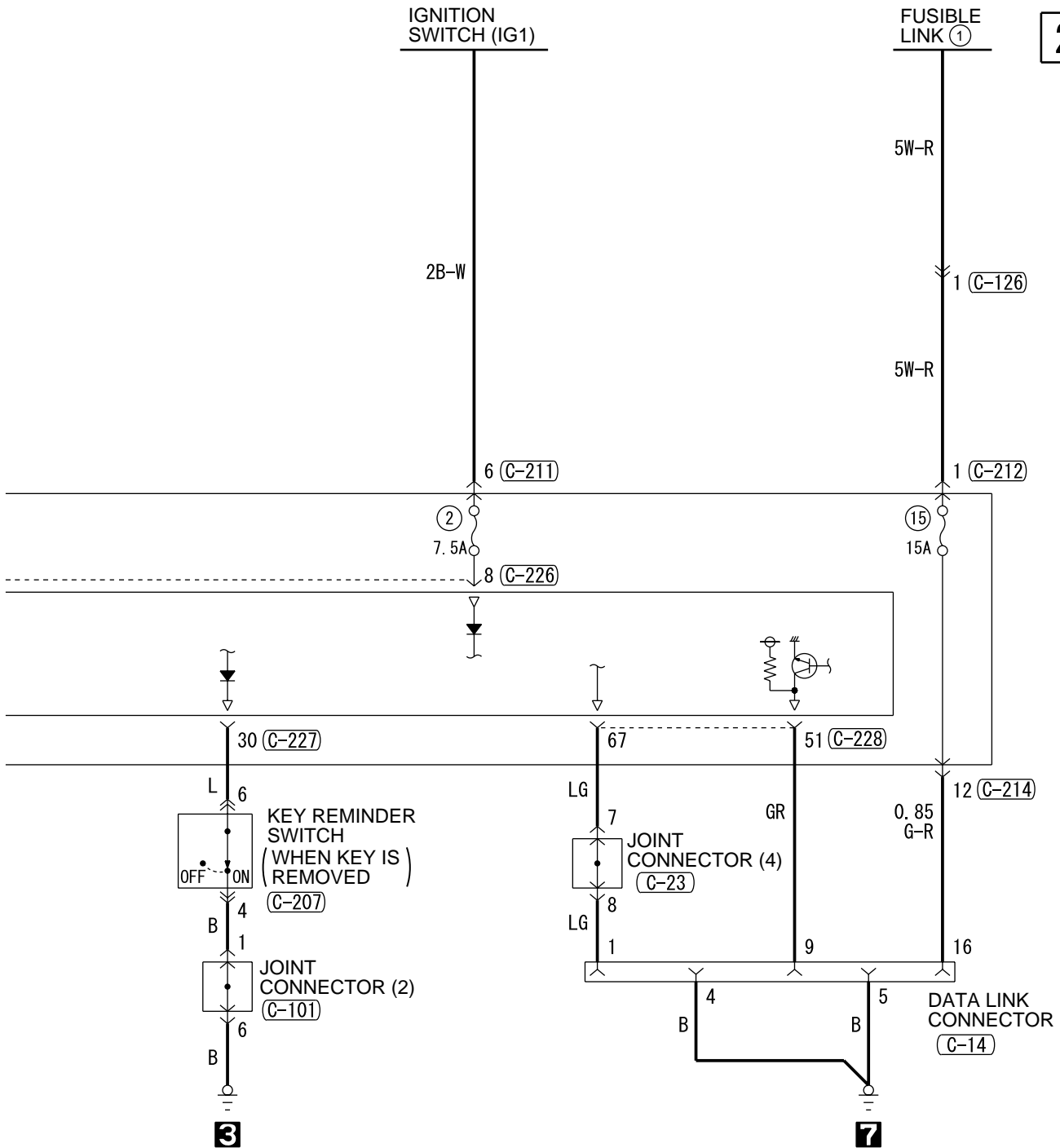

(C-129)

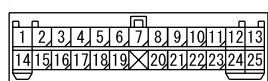

(C-207)

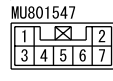

(C-210)

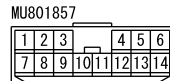

(C-211)



(C-212)



(C-214)

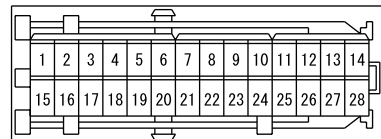

(D-18)



WIRE COLOR CODE

B : BLACK LG : LIGHT GREEN G : GREEN L : BLUE W : WHITE Y : YELLOW
SB : SKY BLUE BR : BROWN O : ORANGE GR : GRAY R : RED P : PINK V : VIOLET

SUNROOF

M1901009900451

1

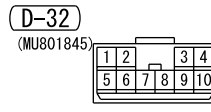
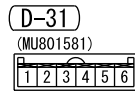
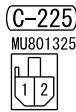
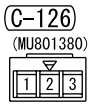
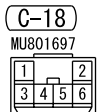
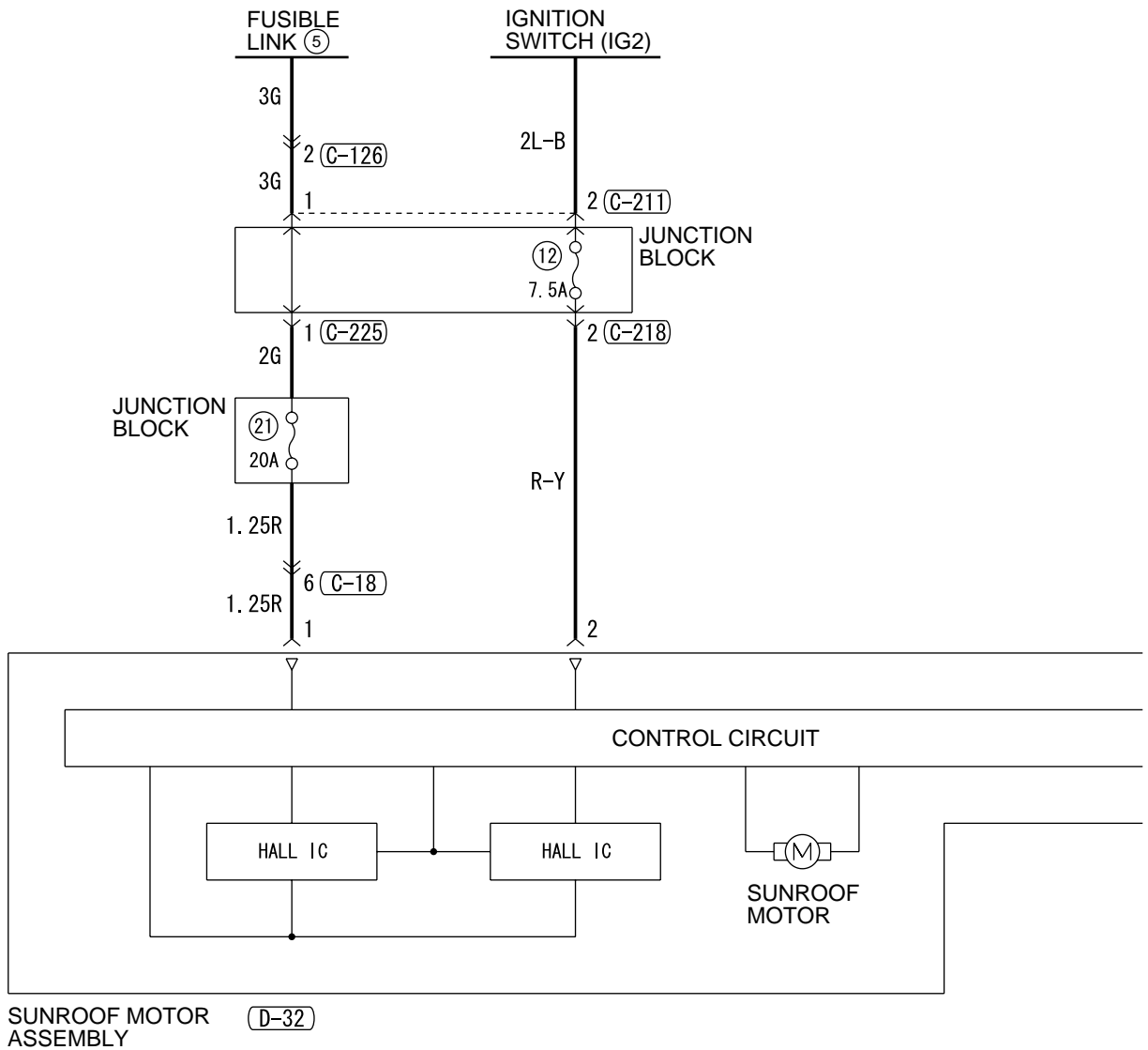

2

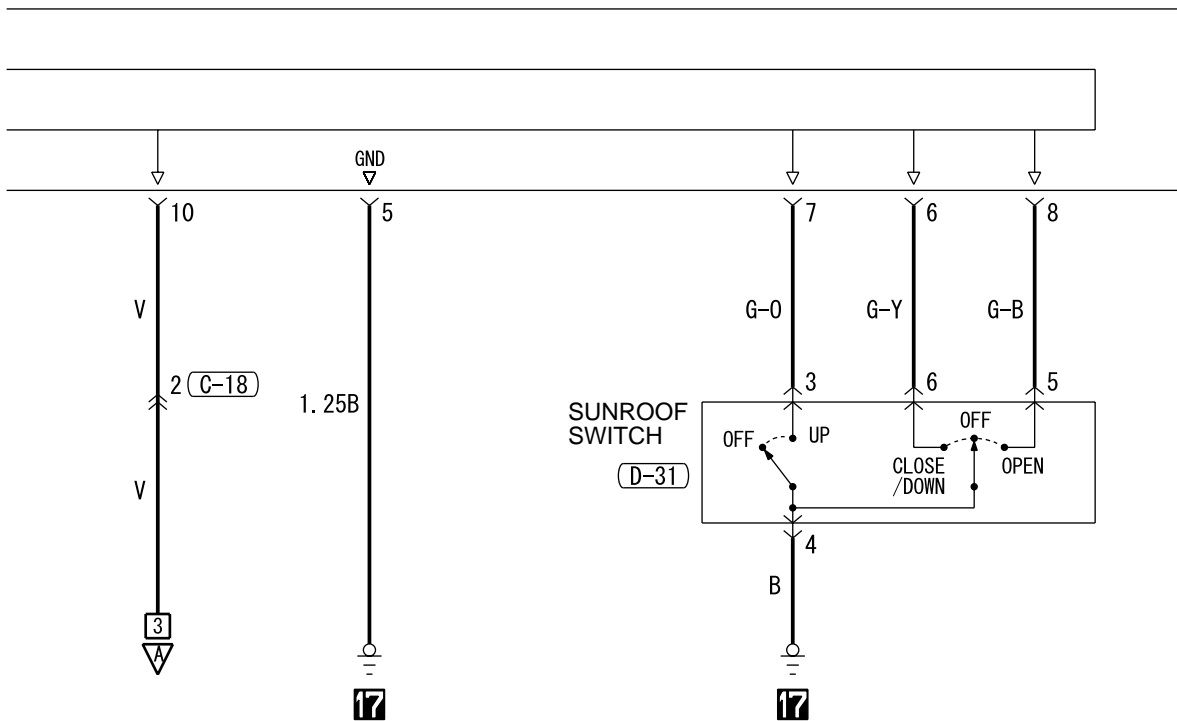

WIRE COLOR CODE
 B : BLACK LG : LIGHT GREEN G : GREEN L : BLUE W : WHITE Y : YELLOW
 SB : SKY BLUE BR : BROWN O : ORANGE GR : GRAY R : RED P : PINK V : VIOLET

H3J15M17AB

TSB Revision

SUNROOF (CONTINUED)

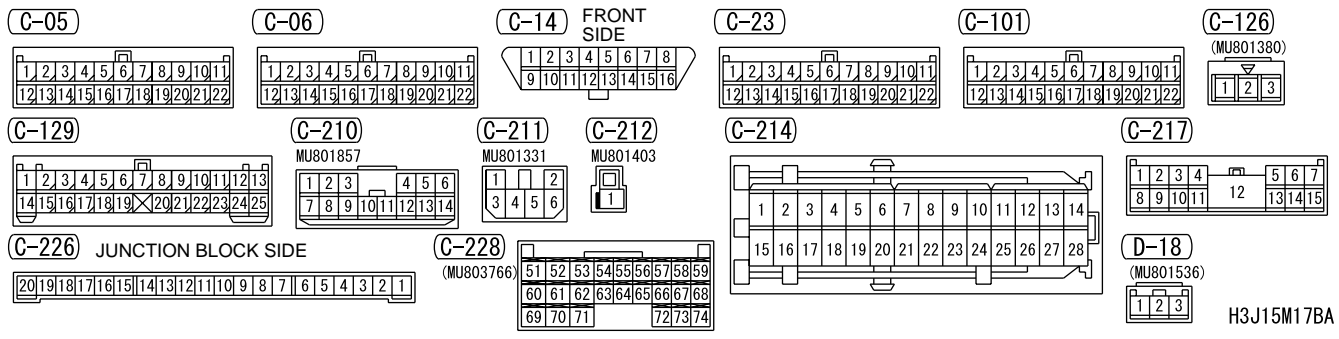
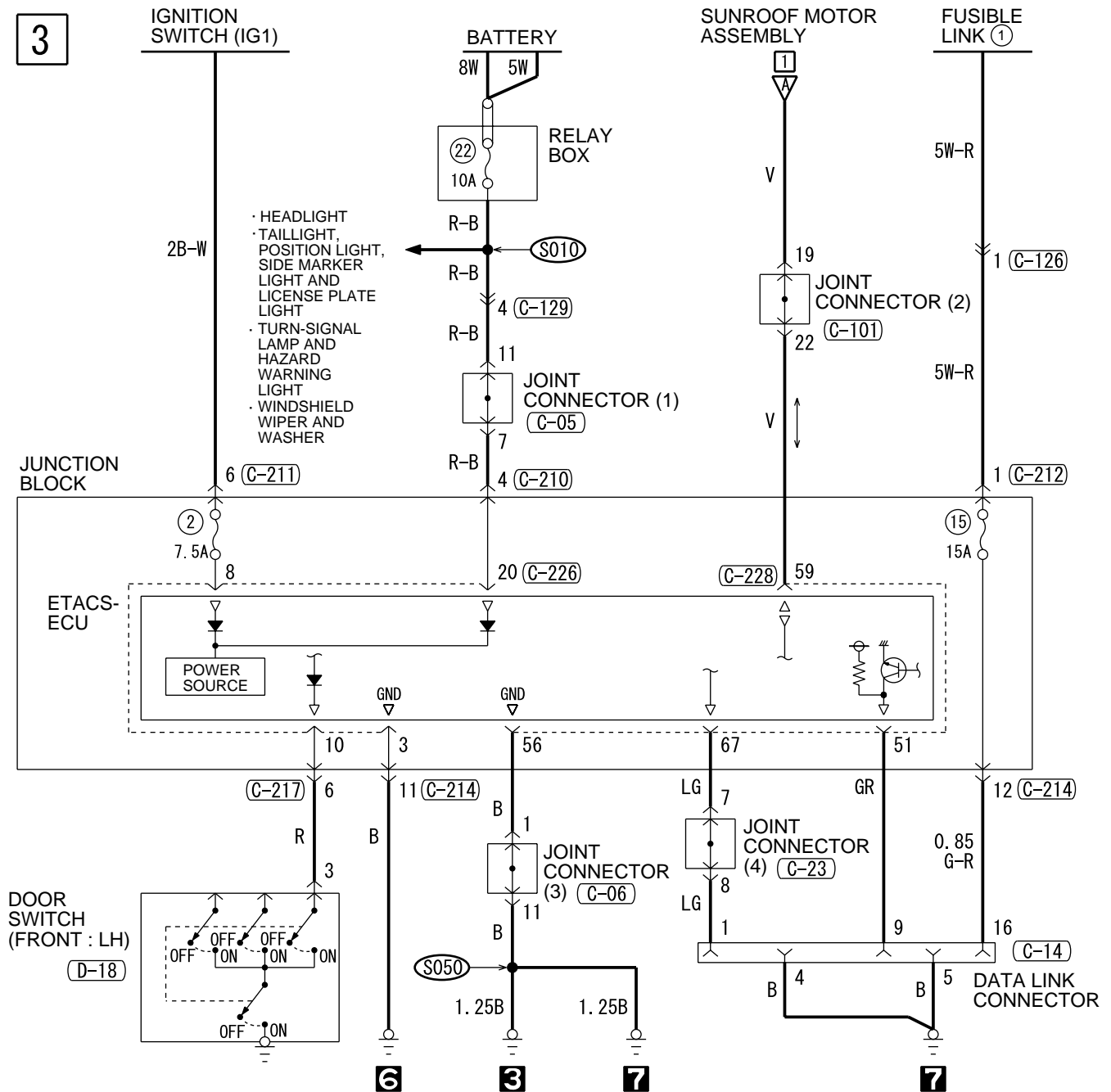

H3J15M17BA

RHEOSTAT

M1901011100496

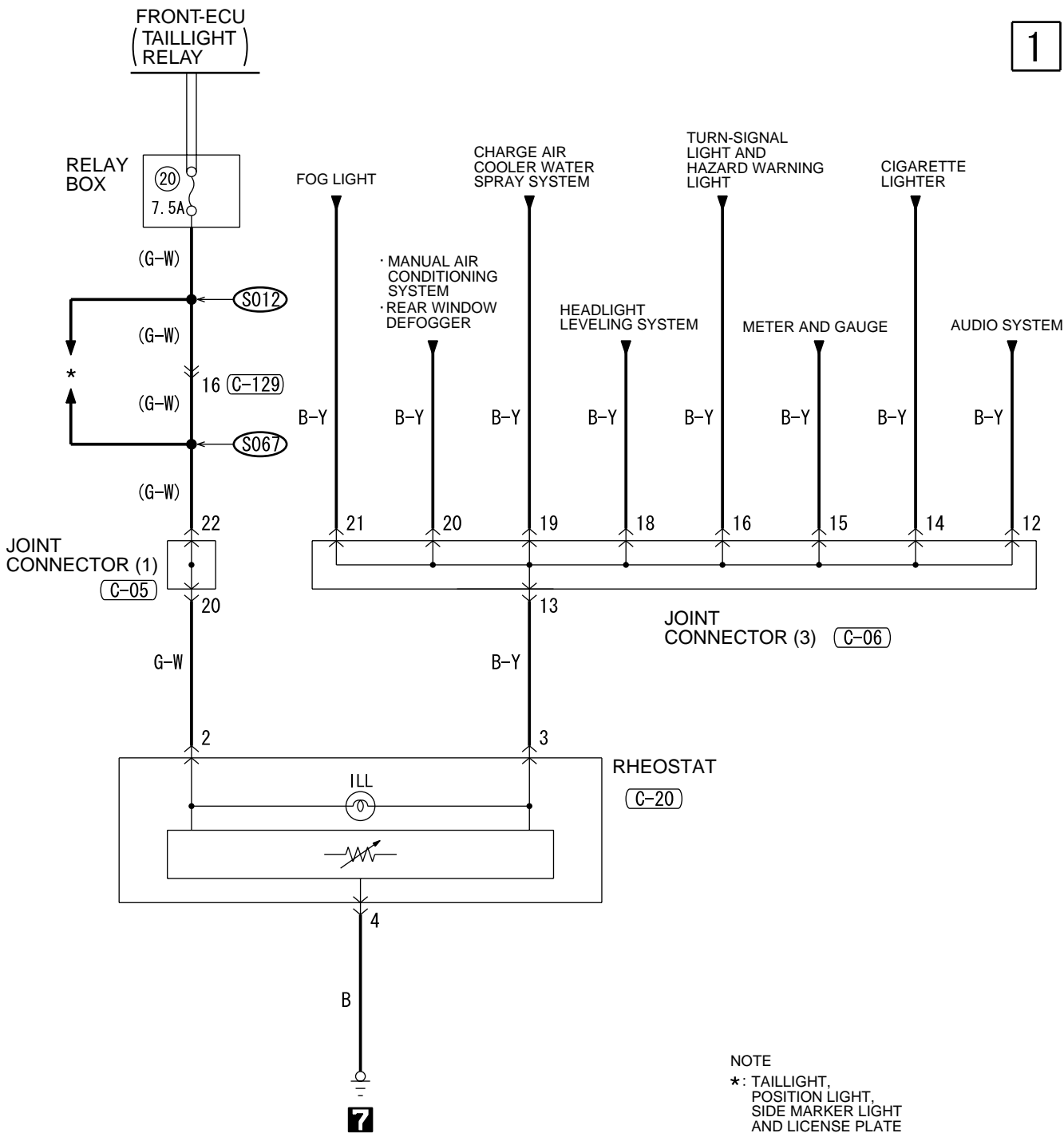

(C-05)

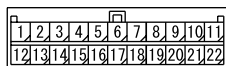

(C-06)

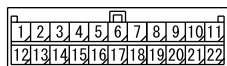

(C-20)

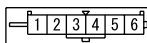

(C-129)

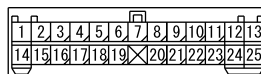

WIRE COLOR CODE

B : BLACK LG : LIGHT GREEN G : GREEN L : BLUE W : WHITE Y : YELLOW
 SB : SKY BLUE BR : BROWN O : ORANGE GR : GRAY R : RED P : PINK V : VIOLET

H3J15M18AA

NOTES